













AFT[®]

AFT-International.com

**MATERIALIEN
MATERIALS
MATERIALEN
MATERIAUX**

2016

-  FARBEN
COLOUR
KLEUR
COULEUR
-  GRÖSSE
SIZE
MAAT
POINTURE
-  BREITE
WIDTH
BREEDETE
LARGEUR
-  LÄNGE
LENGTH
LENGTE
LONGUEUR
-  ABMESSUNGEN
DIMENSIONS
AFMETINGEN
DIMENSIONS
-  STÄRKE
THICKNESS
DIKTE
ÉPAISSEUR
-  INHALT
CONTENT
INHOUD
CONTENU
-  HÄRTE / SHORE
HARDNESS / SHORE
HARDHEID / SHORE
DURETÉ / SHORE
-  FORM
MODEL
MODEL
MODÈLE
-  AUSFÜHRUNG
FINISH
AFWERKING
FINITION
-  MATERIAL
MATERIAL
MATERIAAL
MATIÈRE
-  VERPACKUNGSEINHEIT, P = PAAR
PACKAGING, P = PAIR
EENHEIDSPAKKING, P = PAAR
EMBALLAGE, P = PAIRE
-  SIEHE
SEE
ZIE
VOIR

PRINT 04/2016
 (Technische) Änderungen und Druckfehler vorbehalten
 (Technical) changes and misprints excepted
 Onder voorbehoud van (technische) wijzigingen en drukfouten
 Sous réserve des modification (techniques) et fautes d'impressions

Design/layout: FABworks.be

AFT | IHRE PARTNER

Der Zusammenschluss zweier seit Jahrzehnten weltweit operierender Hersteller mit den Produkten 'EXTRA' und 'MEBUS', sind gemeinsam über 200 Jahre Erfahrung in den Bereichen Orthopädie und Schuhreparatur!

Wir haben die Kompetenz, alle Artikel individuell und flexibel im Sinne des Kunden anbieten zu können.

Das bedeutet nicht nur über ein Sortiment von 30000 Artikeln zu verfügen, sondern vor allem mit dem Know-How vieler sehr erfahrener Mitarbeiter rechnen zu können.

AFT | YOUR PARTNER

The combination of two well respected companies acting since many years world-wide with their products 'EXTRA' and 'MEBUS', means together more than 200 years experience and know-how in the field of orthopaedics and shoe repair!

We have the competency and ability to offer all articles in an individual and flexible way and that according to your requirements.

A team of people with an extensive knowledge of the business and many years of experience is ready to assist you with our extensive range of more than 30.000 articles.

Christophe Speelmans
 AFT INTERNATIONAL | **BELGIUM**



AFT International nv
 Ter Stratenweg 50,
 B-2520 Oelegem, BELGIUM
 T: +32 (0)3 475 93 03
 F: +32 (0)3 475 93 20
info@aft-international.be

AFT | UW PARTNER

De combinatie van twee gerespecteerde firma's die reeds sinds vele jaren wereldwijd hun producten 'EXTRA' en 'MEBUS' verdelen, betekent samen meer dan 200 jaar ervaring en knowhow op het gebied van orthopedie en schoenreparatie!

Wij hebben de deskundigheid en bekwaamheid om u al onze artikels op een individuele en flexibele manier aan te bieden volgens uw behoeften.

Een team van mensen met een uitgebreide kennis van zaken en vele jaren ervaring staat klaar om u verder te helpen met ons zeer uitgebreid assortiment van meer dan 30.000 artikelen.

AFT | VOTRE PARTENAIRE

La combinaison de deux sociétés renommées qui coopèrent depuis longtemps ensemble dans le monde entier par leurs marques déposées 'EXTRA' et 'MEBUS', représente plus de 200 ans d'expérience et savoir-faire dans le domaine de l'orthopédie et de la réparation des chaussures!

Nous avons la compétence ainsi que la possibilité de vous offrir tous les articles d'une manière individuelle et flexible afin de pouvoir répondre à vos exigences.

Une équipe de personnes ayant une connaissance approfondie de notre industrie et de nombreuses années d'expérience, est prêt à vous aider avec notre vaste gamme de plus de 30.000 articles.

Peter Mebus
 AFT INTERNATIONAL | **GERMANY**



AFT International GmbH
 Eichenhofer Weg 1
 D-42279 Wuppertal, GERMANY
 T: +49 (0)202 64774 0
 F: +49 (0)202 64774 20
info@aft-international.de

AFT INTERNATIONAL | GERMANY

WERKSTATTEINRICHTUNGEN
 WORK SHOP FURNISHING
 WERKPLAATSINRICHTING
 ÉQUIPEMENT D'ATELIER **6**

MASCHINEN UND ZUBEHÖR
 MACHINERY AND ACCESSORIES
 MACHINES EN TOEBEHOREN
 MACHINES ET ACCESSOIRES **7**

WERKZEUGEN UND KLEINMASCHINEN
 TOOLS AND SMALL MACHINERY
 GEREEDSCHAPPEN EN KLEINE MACHINES
 OUTILS ET PETITES MACHINES **9**



AFT®

T-International.com

PLATTENMATERIAL
 SHEET MATERIAL
 PLAATMATERIAAL
 PLAQUES **1**

ABSÄTZE, SOHLEN, STREIFEN
 HEELS, SOLES, STRIPES
 HAKKEN, ZOLEN, STROKEN
 TALONS, SEMELLES , BANDES DÉCOUPÉES **2**

EINLAGEN-ROHLINGE UND ZUBEHÖR, FRÄSTECHNIK
 ORTHOPAEDIC FOOT SUPPORTS AND ACCESSORIES, MILLING TECHNIQUES
 STEUNZOLEN EN TOEBEHOREN, FREESTECHNIEK
 SEMELLES ORTHOPÉDIQUES ET ACCESSOIRES, TECHNIQUE À FRAISER **3**

CHEMISCHE PRODUKTE
 CHEMICAL PRODUCTS
 CHEMISCHE PRODUCTEN
 PRODUITS CHIMIQUES **4**

LEDER
 LEATHER
 LEDER
 CUIR **5**

WERKSTATTEINRICHTUNGEN
 WORK SHOP FURNISHING
 WERKPLAATSINRICHTING
 ÉQUIPEMENT D'ATELIER **6**

MASCHINEN UND ZUBEHÖR
 MACHINERY AND ACCESSORIES
 MACHINES EN TOEBEHOREN
 MACHINES ET ACCESSOIRES **7**

EINZELHANDEL
 RETAIL
 WEDERVERKOOP
 ARTICLES DE REVENTE **8**

WERKZEUGEN UND KLEINMASCHINEN
 TOOLS AND SMALL MACHINERY
 GEREEDSCHAPPEN EN KLEINE MACHINES
 OUTILS ET PETITES MACHINES **9**

BESCHLÄGE, SCHLÜSSEL UND ZUBEHÖR
 METAL HARDWARE, KEYS AND ACCESSORIES
 METAALWAREN, SLEUTELS EN TOEBEHOREN
 QUINCAILLERIE, CLÉS ET ACCESSOIRES **10**

GRÖSSENTABELLE
 SIZES
 MATENTABEL
 GABARITS **11**



PLATTENMATERIAL
SHEET MATERIAL
PLAATMATERIAAL
PLAQUES

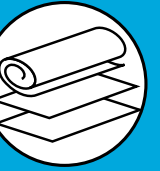
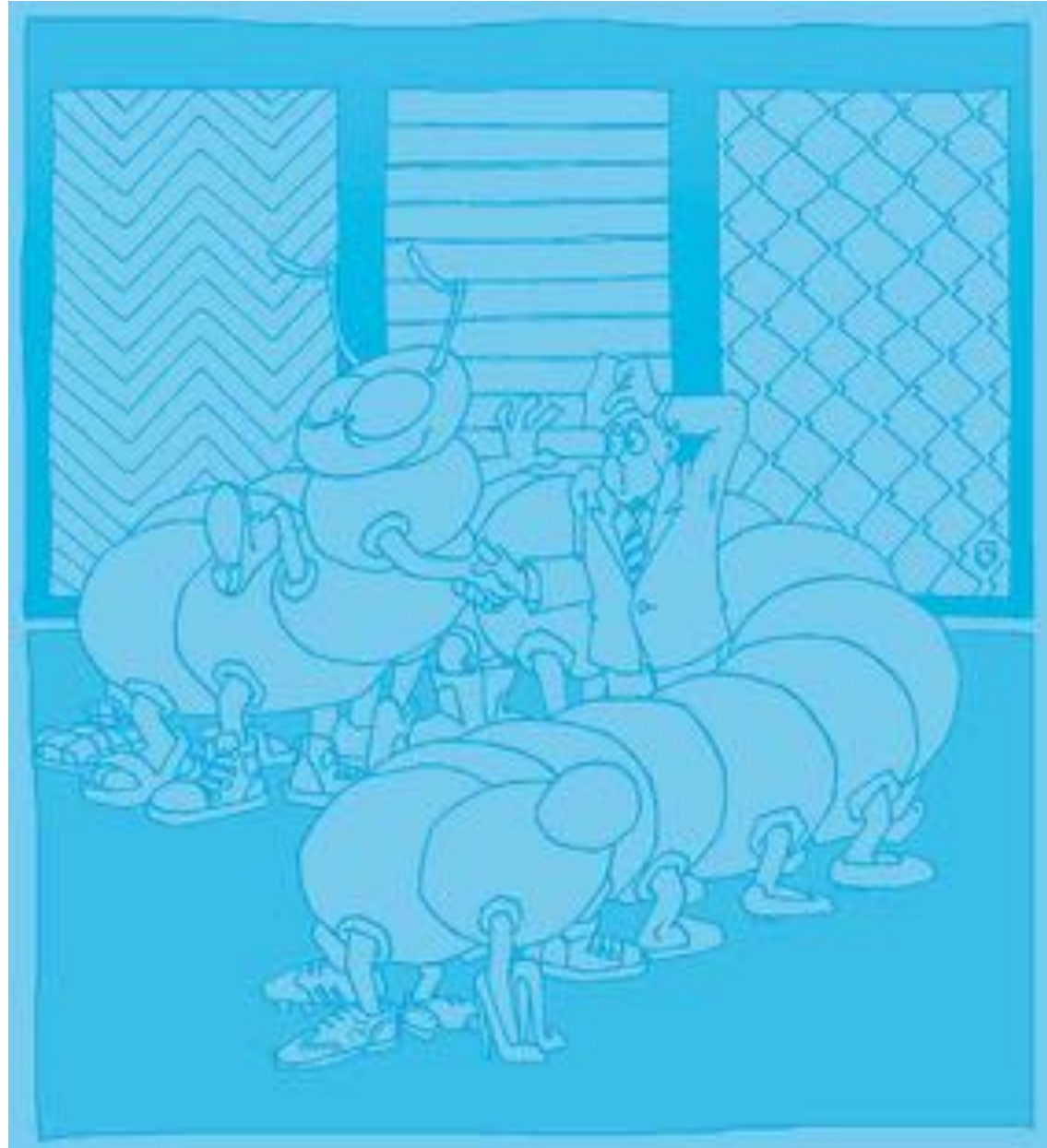

1.01	GUMMI RUBBER RUBBER CAOUTCHOUC	1.2
1.02	MIKRO ZELLULARGUMMI MICRO CELLULAR RUBBER MICRO CELLULAIRE RUBBER CAOUTCHOUC MICRO CELLULAIR	1.8
1.03	EVA	1.10
1.04	POLYETHYLEN-SCHAUMSTOFF POLYETHYLENE-FOAM POLYETHYLEEN, SCHUIMSTOF MOUSSE POLYÉTHYLÈNE	1.18
1.05	CAD/CAM FRÄSMATERIALIEN MILLING MATERIALS FREESMATERIALIEN MATÉRIAUX À FRAISER	1.20
1.06	KORK CORK KURK LIÈGE	1.26
1.07	VERSTEIFUNGSSTOFFE STIFFENING TISSUES VERSTIJVINGSSTOFFEN TOILES THERMOCOLLANTES	1.30
1.08	STOSSDÄMPFENDE MATERIALIEN SHOCKABSORBING MATERIAL SCHOKABSORBERENDE MATERIALIEN MATÉRIAUX ABSORBANT DE CHOC	1.34
1.09	LAMINATEN LAMINATES LAMINATEN LAMINAGES	1.40
1.10	BRANDSOHLENMATERIAL MATERIAL FOR BASE SOLES MATERIAAL VOOR GRONDPATRONEN MATÉRIAUX POUR PREMIÈRES	1.41
1.11	VAKUUMTECHNIK VACUUM TECHNICS VACUÛMTECHNIEK TECHNIQUE PNEUMATIQUE	1.42
1.12	THERMOPLASTEN THERMOPLASTS THERMOPLASTEN THERMOPLASTIQUES	1.43
1.13	SYNTHETISCHE BEZUGSSTOFFE SYNTHETIC TISSUES SYNTHETISCHE BEKLEDINGSSTOFFEN TISSUES SYNTHÉTIQUES	1.44
1.14	RAHMEN WELTS RANDE TRÉPOINTES	1.50

VULKOLAN VKL 1308.



Sehr abriebfest (DIN 60), ideal für Damenflecke
Very good abrasion resistance (DIN 60), ideal for ladies' heels
Zeer slijtvast (DIN 60), ideaal voor dameshakken
Très bonne résistance à l'abrasion, idéal pour les talons dames

50 x 50cm

Shore A80

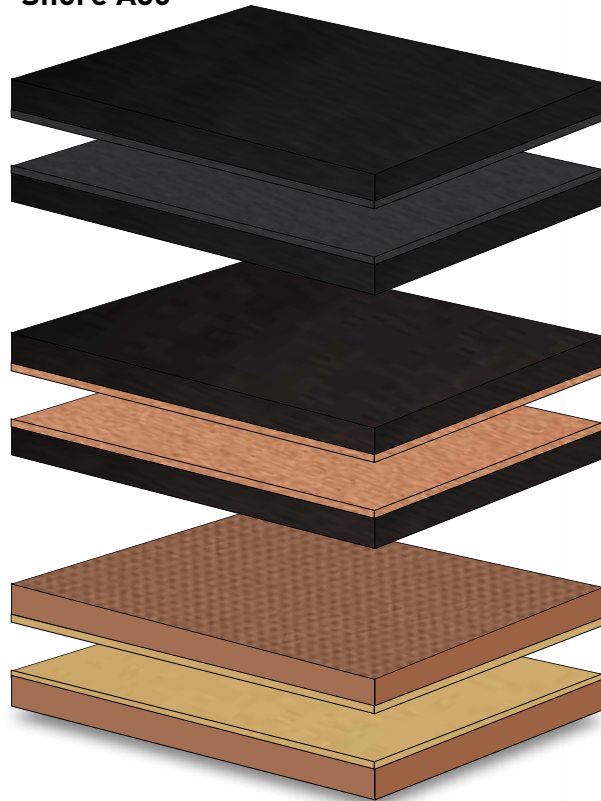

			□	1	4
□	VKL glatt smooth glad lisse + Gummi rubber caoutchouc	4,5 mm 1,2 mm	•	•	
1	VKL glatt smooth glad lisse + Leder leather leder cuir	4,5 mm 1,2 mm	•	•	
5	VKL Diamant + Gummi rubber caoutchouc	4,5 mm 1,2 mm	•	•	•

Wir liefern Ihnen diese Platten auch gestanzt in jeder Größe.
We supply all these materials cut in all different sizes.
Deze platen kunnen gestanst worden in alle mogelijke modellen.
Nous fournissons ces plaques dans chaque modèle découpé.

VULKOSVIG 130890.



NEU
NEW
NIEUW
NOUVEAU

24 x 31cm

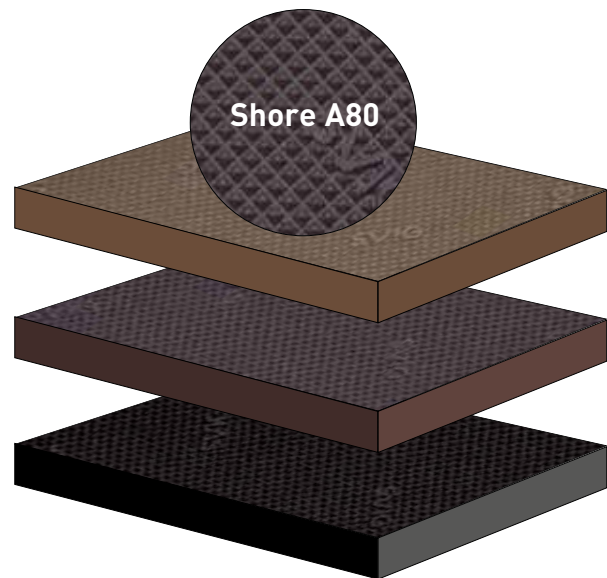

			□	1	7
	6 mm		•	•	•

Farbabweichungen zwischen dem Farbdruck und dem Originalprodukt sind möglich.
Colour differences between print and original product are possible.
Kleurverschillen tussen het drukwerk en het origineel product zijn mogelijk.
Des différences de couleur entre l'imprimerie et la produit originale sont possible.

CROWN 1303.



Abrieb DIN 180
Abrasion DIN 180
Slijtwearstand DIN 180
Abrasion DIN 180

100 x 50cm

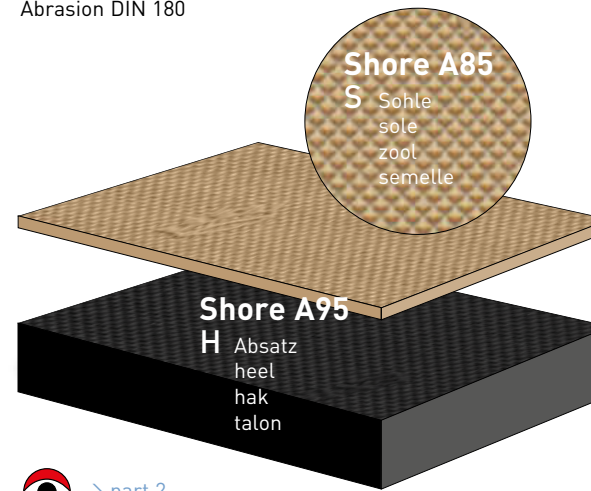

→ part 2
→ part 11

Wir liefern Ihnen diese Platten auch gestanzt in jeder Größe.
We supply all these materials cut in all different sizes.
Deze platen kunnen gestanst worden in alle mogelijke modellen.
Nous fournissons ces plaques dans chaque modèle découpé.

			□	1	4
18	1,8 mm S		•	•	•
25	2,5 mm S		•	•	•
30	3 mm S		•	•	
35	3,5 mm S		•	•	
40	4 mm S		•	•	
50	5 mm S		•	•	
60	6 mm H		•	•	•
80	8 mm H			•	
99	10 mm H			•	

DUO-TOP 1305.



Kombination von 2 verschiedene Gummi: härtere formfeste Unterschicht,
weiche aber sehr abriebfeste Oberschicht.

63 x 73cm

Combination of 2 rubbers: harder bottom layer which is retaining his
shape, softer but strong abrasion resistant top layer.

Combinatie van 2 rubbers: hardere vormvaste onderlaag, zachte uiterst
sterke slijtvaste toplaag.

Combinaison de 2 caoutchouc: base dur pour stabiliser la forme, dessus
mou, flexible et extrêmement solide.



Oberschicht in 1,8 mm auch separat
zur Verfügung als Sohlenmaterial.

Top layer is also separate available
in 1,8 mm for soles.

Toplaag is ook apart verkrijgbaar
als zolenmateriaal in 1,8 mm dikte.

Le dessus est également disponible
en 1,8 mm comme matériel de res-
semelage.

			□	1	7
18	1,8 mm S		•	•	•
25	2,5 mm S		•	•	•
35	3,5 mm S		•	•	
60	6 mm H		•	•	•

VULKOLAN, VULKOSVIG,
CROWN, DUO-TOP

□	1	4	7
schwarz black zwart noir	braun brown bruin brun	beige	karamell toffee karamel caramel



GUM-TOP 1335.    1



57 x 90cm

		0	1
60	6 mm H	•	•

 → part 2

SEBAGO 13061.    1

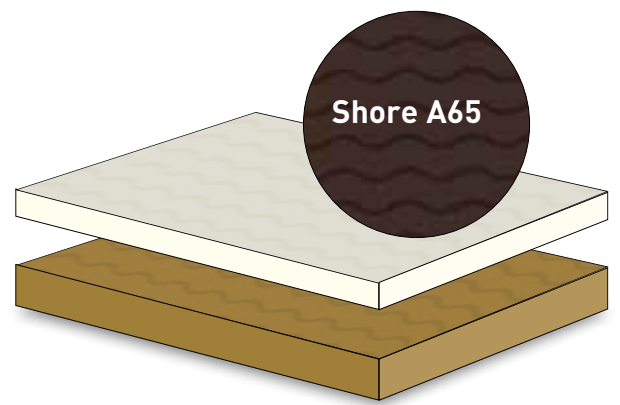

73 x 63cm

		0	1	6	7
40	4 mm	•	•	•	•
60	6 mm	•	•	•	•

COMPACT RUBBER 13091.    1



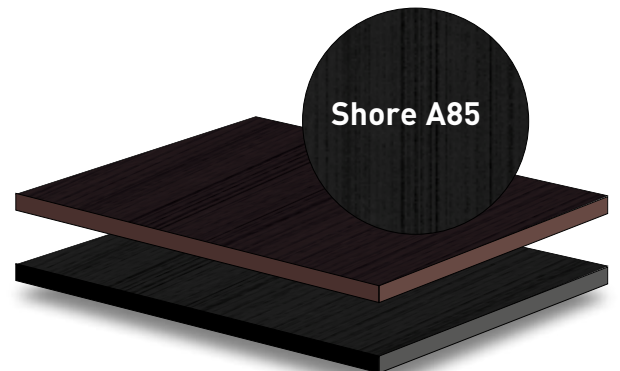

Beidseitig aufgerauht; Ideales Zwischensohlenmaterial zum Nähen
 Sanded on both sides; Ideal innersole material for stitching
 Geruwd langs beide zijden; Ideaal door te naaien tussenzool materiaal
 Cardé deux faces; Intercalaire idéale pour coudre à la machine

100 x 50cm



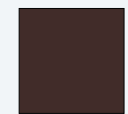

		181	146
		schwarz black zwart noir	dunkelbraun dark brown donkerbruin brun foncé
25	2,5 mm	•	•

GUM-TOP, SEBAGO, RUGUEUX, RASTRE, MEXICO DIAMANTINO, DIAMANTINO FINE, CROSS, WAVE, HEAVY GRIP

					
0	1	4	5	6	7
schwarz black zwart noir	braun brown bruin brun	beige	dunkelblau dark blue donkerblauw bleu foncé	weiß white wit blanc	karamell toffee karamel caramel

 → part 11
 Grössentabelle
 Sizes
 Matentabel
 Gabarits

Wir liefern Ihnen diese Platten auch gestanzt in jeder Größe.
 We supply all these materials cut in all different sizes.
 Deze platen kunnen gestanst worden in alle mogelijke modellen.
 Nous fournissons ces plaques dans chaque modèle découpé.

RUGUEUX 13063.    1

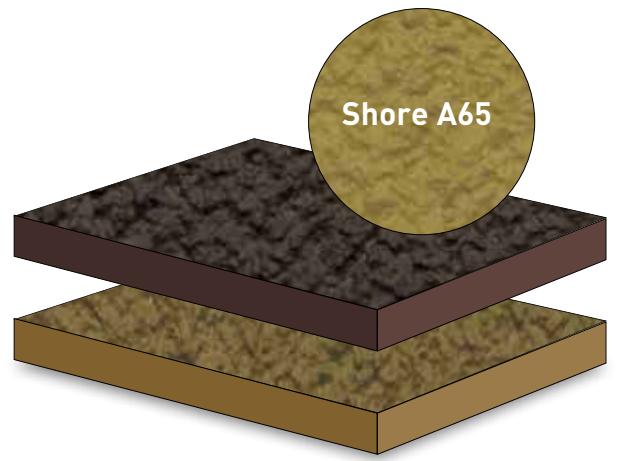

73 x 63cm

		0	1	4	7
30	3 mm	•	•	•	•
40	4 mm	•	•	•	•
50	5 mm	•			
60	6 mm	•	•	•	•

RASTRE 13065.    1

 → part 2

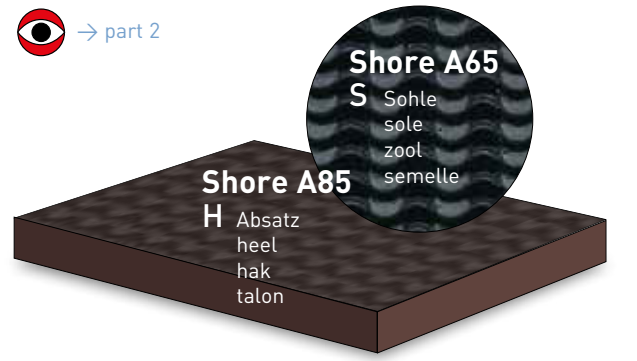

73 x 63cm

		0	1	4	7
40	4 mm S	•	•	•	•
60	6 mm S	•	•	•	•
60H	6 mm H	•	•		

MEXICO DIAMANTINO 13208.    1

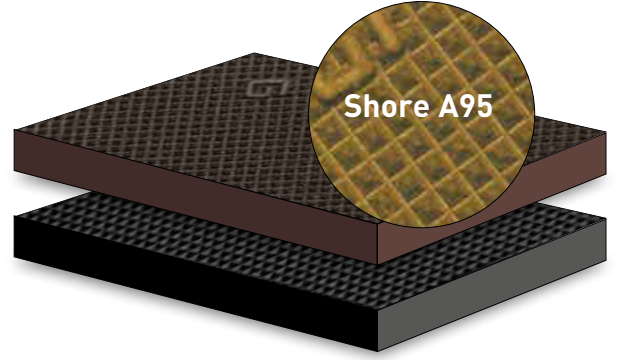

73 x 63cm

		0	1	7
60	6 mm	•	•	•

DIAMANTINO FINE 13207.5.   1

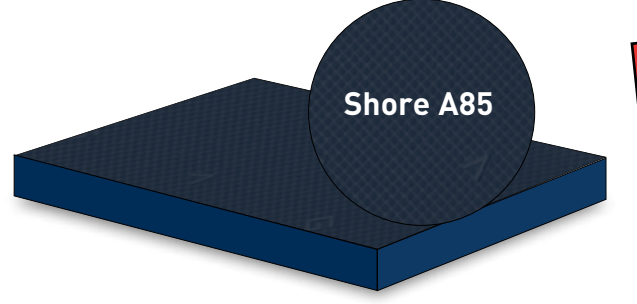

73 x 63cm

NEU
NEW
NIEUW
NOUVEAU

		5
18	1,8 mm	•
60	6 mm	•

Farbabweichungen zwischen dem Farbdruck und dem Originalprodukt sind möglich.
 Colour differences between print and original product are possible.
 Kleurverschillen tussen het drukwerk en het origineel product zijn mogelijk.
 Des différences de couleur entre l'imprimerie et la produit originale sont possible.

CROSS 1301.



63 x 73cm

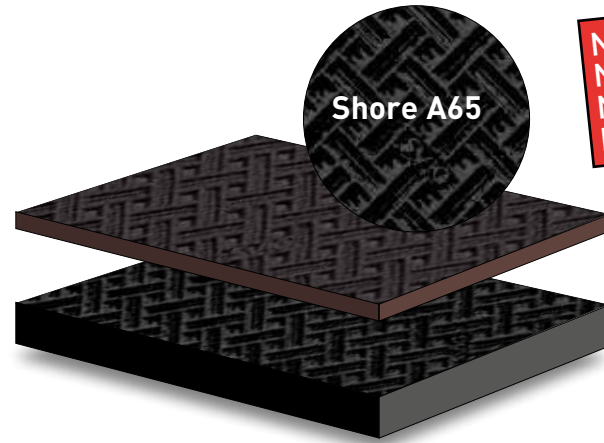

		0	1	7
40	4 mm	•	•	•
60	6 mm	•	•	•

→ part 2
→ part 11

WAVE 1302.



63 x 73cm

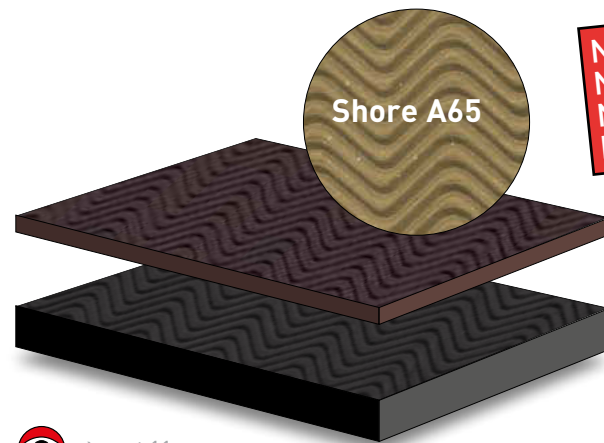

		0	1	7
20	2 mm	•	•	•
60	6 mm	•	•	•

→ part 11

HEAVY GRIP 1307.



63 x 73cm

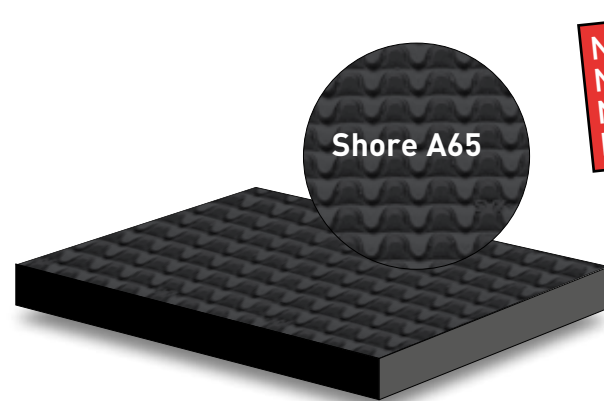

		0	1
40	4 mm	•	•
60	6 mm	•	•

→ part 11

Wir liefern Ihnen diese Platten auch gestanzt in jeder Größe.
We supply all these materials cut in all different sizes.
Deze platen kunnen gestanst worden in alle mogelijke modellen.
Nous fournissons ces plaques dans chaque modèle découpé.

CREPINA SOFT 7107.



92 x 86cm

Laufsohlenplatte mit Krepp-Profil, weich; sehr abriebfest DIN 160, Dichte 1,12 Gr/cm³
Rubber solesheet, soft, profile crêpe; very good abrasion resistance DIN 160, Density 1,12 gr/cm³
Loopzolenplaat in zacht rubber, met crêpe-profiel; zeer goede slijtvastheid DIN 160, dichtheid 1,12 g/cm³
Plaque à semelles en caoutchouc souple, avec profil crêpe; très bonne résistance à l'abrasion DIN 160, densité 1,12 gr/cm³

CREPINA HARD 7108.



92 x 86cm

Absatzplatte mit Krepp-Profil, hart; sehr abriebfest DIN 200, Dichte 1,12 Gr/cm³
Rubber heelsheet, hard, profile crêpe; very good abrasion resistance DIN 200, Density 1,12 gr/cm³
Hakkenplaat in hard rubber, met crêpe-profiel; zeer goede slijtvastheid DIN 200, dichtheid 1,12 g/cm³
Plaque à talons en caoutchouc dur, avec profil crêpe; très bonne résistance à l'abrasion DIN 200, densité 1,12 gr/cm³

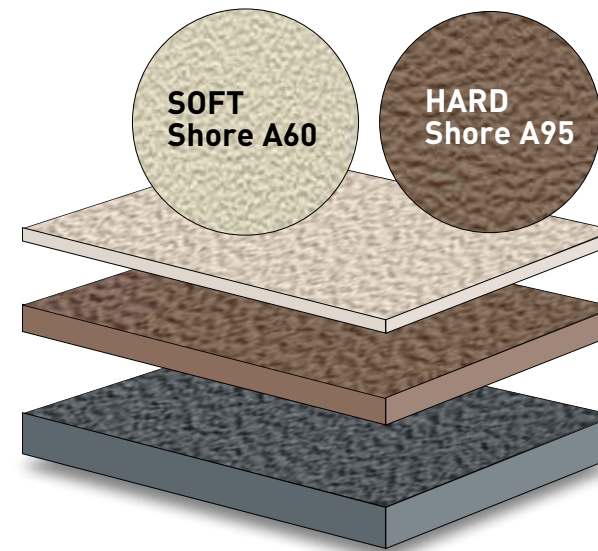

		CREPINA SOFT 7107		CREPINA HARD 7108	
		181	146		
		in 16 Farben all 16 colours alle 16 kleuren les 16 couleurs	schwarz black zwart noir	braun brown brun brun	in 16 Farben all 16 colours alle 16 kleuren les 16 couleurs
02	2 mm	•	•	•	
03	3 mm		•	•	
04	4 mm	•	•	•	
05	5 mm		•	•	
06	6 mm	•	•	•	•

→ part 2
→ part 11

Wir liefern Ihnen diese Platten auch gestanzt in jeder Größe.
We supply all these materials cut in all different sizes.
Deze platen kunnen gestanst worden in alle mogelijke modellen.
Nous fournissons ces plaques dans chaque modèle découpé.

CREPINA SOFT,
CREPINA HARD

109	111	166	197	181	105	189	187
weiß white wit blanc	hellgrau light grey lichtgrijs gris clair	mittelgrau medium grey middelgrijs gris moyen	dunkelgrau dark grey donkergrijs gris foncé	schwarz black zwart noir	hellbeige light beige lichtbeige beige clair	arena	tierra
135	185	122	198	146	106	178	159
beige	taupe antelope leverbeige gabardine	hellbraun light brown lichtbruin brun clair	otter	dunkelbraun dark brown donkerbruin brun foncé	rot red rood rouge	dunkelblau dark blue donkerblauw bleu foncé	dunkelgrün dark green donkergroen vert foncé

Farbabweichungen zwischen dem Farbdruck und dem Originalprodukt sind möglich.
Colour differences between print and original product are possible.
Kleurverschillen tussen het drukwerk en het origineel product zijn mogelijk.
Des différences de couleur entre l'imprimerie et la produit originale sont possible.

SUPRALITE 1325.

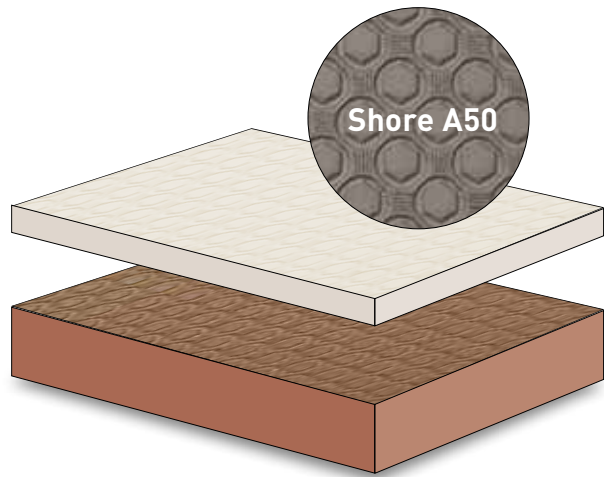

110 x 75cm

* in 7 Farben in 7 colours in 7 kleuren en 7 couleurs		
04	4 mm	•
06	6 mm	•
08	8 mm	•
10	10 mm	•

ZEPHIR TRIANGLE 1323.

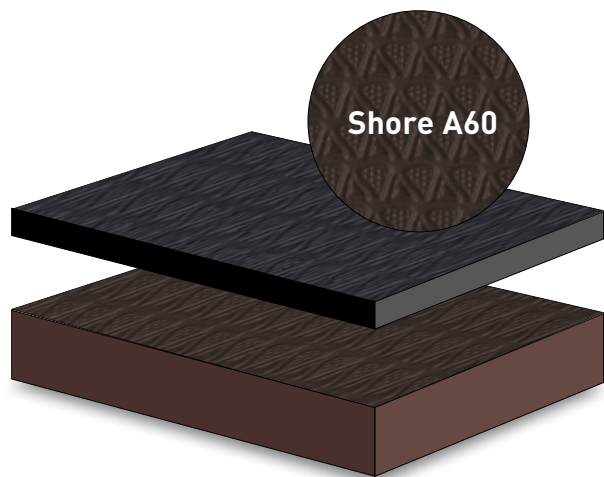

89 x 71cm

181		146	
schwarz black zwart noir		dunkelbraun dark brown donkerbruin brun foncé	
04	4 mm	•	•
06	6 mm	•	•
08	8 mm	•	•
10	10 mm	•	•

ZEPHIR SHELL 1322.

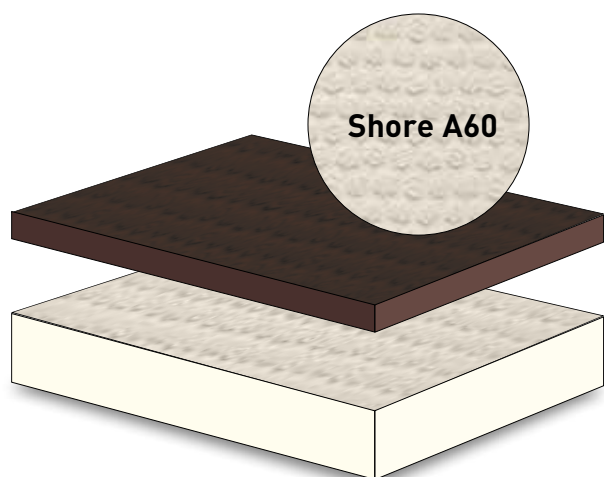

89 x 71cm

181		146		109	
schwarz black zwart noir		dunkelbraun dark brown donkerbruin brun foncé		weiß white wit blanc	
04	4 mm	•	•	•	•
06	6 mm	•	•	•	•
08	8 mm	•	•	•	•
10	10 mm	•	•	•	•

Reiner expandierter Gummi, Gleitschutz, guter abriebwert DIN 180-220, Dichte 0,50 Gr/cm³
Pure expanded rubber, antiskid, good abrasion resistance DIN 180-220, density 0,50 gr/cm³
Zuiver geëxpandeerde rubber, antislip, goede slijtweerstand DIN 180-220, dichtheid 0,50 g/cm³
Caoutchouc pur expansé, antidérapant, bonne résistance à l'abrasion DIN 180-220, densité 0,50 gr/cm³

NOPAIR-BT 7103.

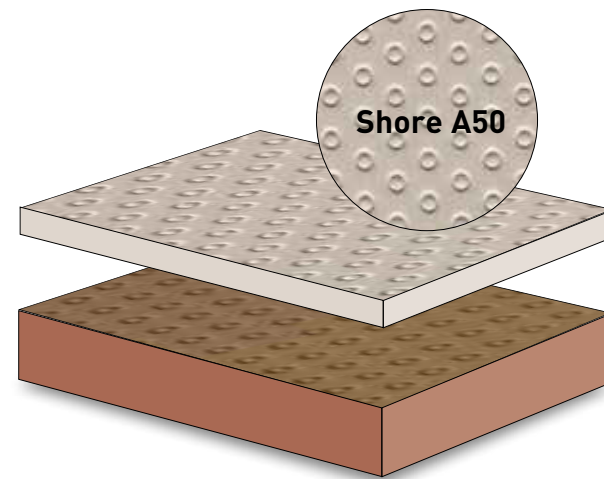

110 x 75cm

in 16 Farben all 16 colours alle 16 kleuren toutes les 16 couleurs		
04	4 mm	•
06	6 mm	•
08	8 mm	•
10	10 mm	•

→ part 11

Wir liefern Ihnen diese Platten auch gestanzt in jeder Größe.
We supply all these materials cut in all different sizes.
Deze platen kunnen gestanzt worden in alle mogelijke modellen.
Nous fournissons ces plaques dans chaque modèle découpé.

SUPRALITE*, ZEPHIR, NOPAIR

109	111	166	197	181	105	189	187
weiß white wit blanc	hellgrau light grey lichtgrijs gris clair	mittelgrau medium grey middelgrijs gris moyen	dunkelgrau dark grey donkergrijs gris foncé	schwarz black zwart noir	hellbeige light beige lichtbeige beige clair	arena	tierra
135	185	122	198	146	106	178	159
beige	taupe antelope leverbeige gabardine	hellbraun light brown lichtbruin brun clair	otter	dunkelbraun dark brown donkerbruin brun foncé	rot red rood rouge	dunkelblau dark blue donkerblauw bleu foncé	dunkelgrün dark green donkergroen vert foncé

Farbabweichungen zwischen dem Farbdruck und dem Originalprodukt sind möglich.
Colour differences between print and original product are possible.
Kleurverschillen tussen het drukwerk en het origineel product zijn mogelijk.
Des différences de couleur entre l'imprimerie et la produit originale sont possible.

SUPERSOFTAIR 7101.

Zwischensohlenmaterial, glatt, leicht, weich und elastisch.
 Innersole material, soft, light and elastic.
 Tussenzoolmateriaal, extra licht, zacht en veerkrachtig.
 Plaque à semelles intercalaire, extra-légère, douce et très élastique.

Shore A30 105 x 87cm

SOFTAIR 7102.

Zwischensohlenmaterial, glatt, geschliffen und flexibel; Dichte 0,20 Gr/cm³
 Innersole material, soft, smooth, sanded; density 0,20 gr/cm³
 Tussenzoolmateriaal, zacht en glad geschuurd; dichtheid 0,20 g/cm³
 Plaque à semelles intercalaire, souple, lisse et cardée; densité 0,20 gr/cm³

Shore A45 100 x 82cm

HARDAIR LIGHT 7104.

Zwischenmaterial für Absätze, glatt, geschliffen und hart; Dichte 0,28 Gr/cm³
 Innerheel material, hard, smooth, sanded; density 0,28 gr/cm³
 Hard en glad tussenbouw materiaal voor hakken; dichtheid 0,28 g/cm³
 Plaque à talons intercalaire, dure, lisse et cardée; densité 0,28 gr/cm³

Shore A55/60 85 x 95cm

HARDAIR 7105.

Zwischenmaterial für Absätze, glatt, geschliffen und hart; Dichte 0,36 Gr/cm³
 Innerheel material, hard, smooth, sanded; density 0,36 gr/cm³
 Hard en glad tussenbouw materiaal voor hakken; dichtheid 0,36 g/cm³
 Plaque à talons intercalaire, dure, lisse et cardée; densité 0,36 gr/cm³

Shore A60 135 x 85cm

SUPERHARDAIR 7106.

Shore A75/80 125 x 75cm

	SUPER SOFTAIR 7101	SOFTAIR 7102	HARDAIR LIGHT 7104	HARDAIR 7105	SUPER HARDAIR 7106
	in 16 Farben all 16 colours alle 16 kleuren les 16 couleurs	+pistache in 16 Farben all 16 colours alle 16 kleuren les 16 couleurs	109 146 181	in 16 Farben all 16 colours alle 16 kleuren les 16 couleurs	in 16 Farben all 16 colours alle 16 kleuren les 16 couleurs
015 1,5 mm	•	•		•	
02 2 mm	•	•	•	•	
04 4 mm	•	•	•	•	
05 5 mm	•	•	•	•	
06 6 mm	•	•	•	•	
08 8 mm	•	•	•	•	
10 10 mm	•	•	•	•	
12 12 mm	•	•	•	•	•
15 15 mm	•	•	•	•	
20* 20 mm	•	•	•	•	
24 24 mm			•	•	
30* 30 mm	•	•	•	146 181	

SUPER SOFTAIR SOFTAIR
 FRÄSTECHNIK MILLING TECHNIQUES FREESTECHNIËK TECHNIQUES À FRAISER
 → page 3.4 - 3.13

* Keile/Stripes/Keilen/Bandes biseautées

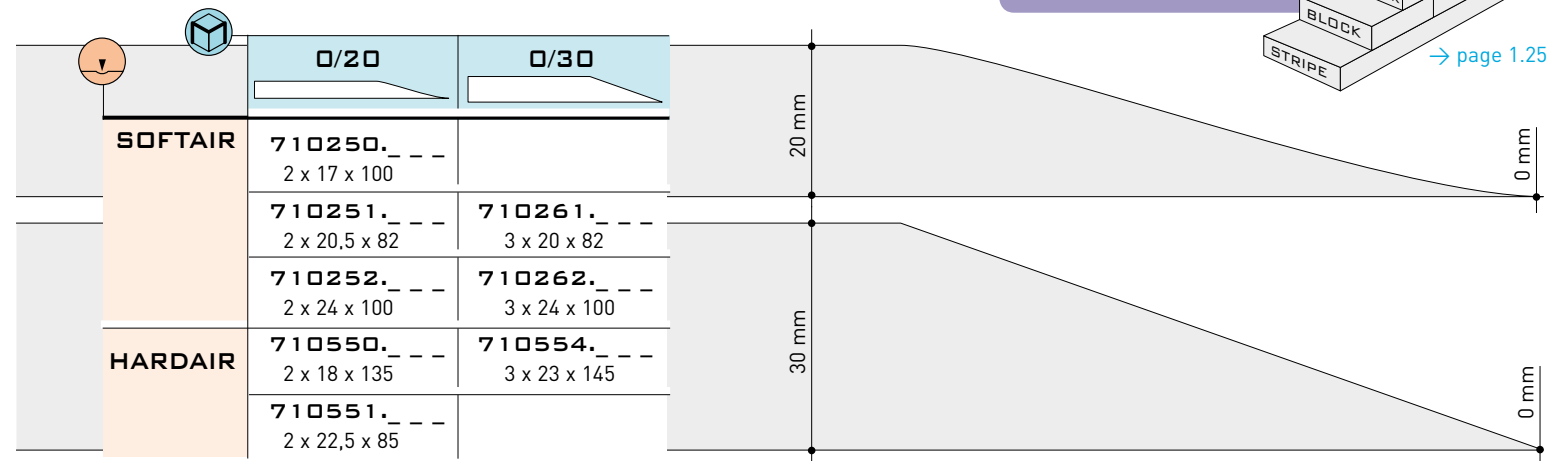

HARDAIR CUNA 7105730.

Keile/Stripes/Keilen/Bandes biseautées

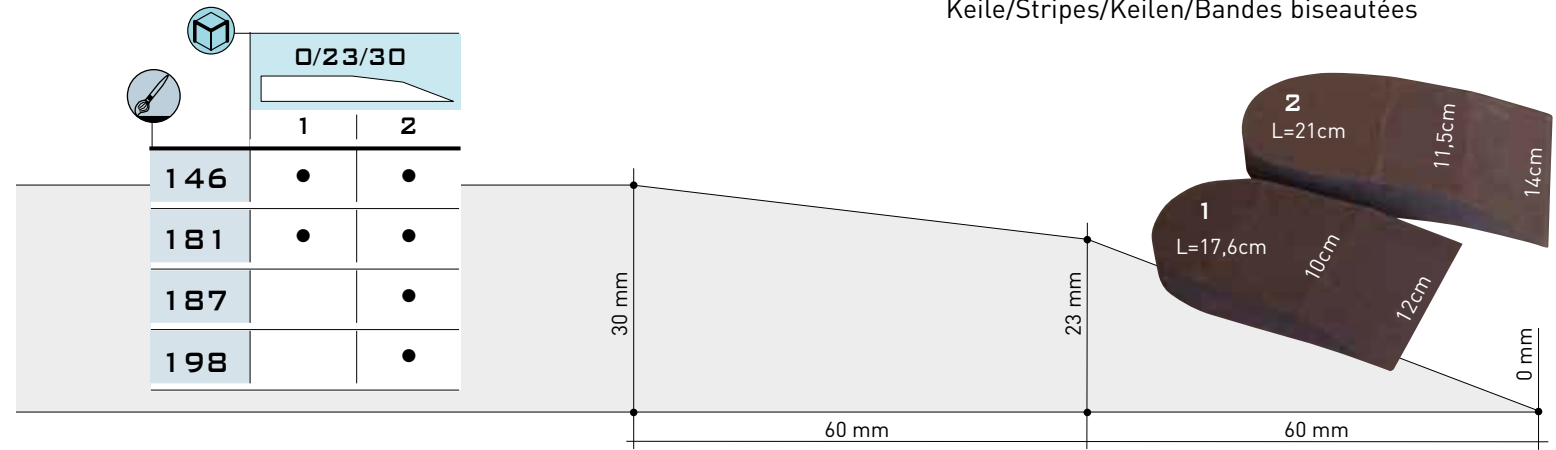

SUPERSOFTAIR, SOFTAIR, HARDAIR LIGHT, HARDAIR, SUPERHARDAIR, HARDAIR CUNA

109	111	166	197	181	105	189	187	
weiß white wit blanc	hellgrau light grey lichtgrijs gris clair	mittelgrau medium grey middelgrijs gris moyen	dunkelgrau dark grey donkergrijs gris foncé	schwarz black zwart noir	hellbeige light beige lichtbeige beige clair	arena	tierra	
135	185	122	198	146	106	178	159	171
beige	taupe antelope leverbeige gabardine	hellbraun light brown lichtbruin brun clair	otter	dunkelbraun dark brown donkerbruin brun foncé	rot red rood rouge	dunkelblau dark blue donkerblauw bleu foncé	dunkelgrün dark green donkergroen vert foncé	pistache

Farbabweichungen zwischen dem Farbdruck und dem Originalprodukt sind möglich.
 Colour differences between print and original product are possible.
 Kleurverschillen tussen het drukwerk en het origineel product zijn mogelijk.
 Des différences de couleur entre l'imprimerie et la produit originale sont possible.

Extrafoam

VORTEILE
 Sehr leichtes Material -
 Hervorragend geeignet zur thermischen Verformung von 90°C bis 120°C -
 Ideal für Orthesenbau, Fußbettungen und Einlagen -
 Nur geringe Schrumpfung -
 Langanhaltende, stossdämpfende Wirkung -
 Hautfreundlich -
 Sehr gutes Preis-/Leistungsverhältnis -

ADVANTAGES
 Very light material -
 Perfect for thermo moulding from 90°C to 120°C -
 Ideal for the construction of orthoses, insoles and orthopaedic foot supports -
 Light shrinkage -
 Long shock absorbing effect -
 Skin friendly -
 Perfect balance between price and quality -

VOORDELEN
 Zeer licht materiaal -
 Extreem goed thermisch vervormbaar tussen 90°C en 120°C -
 Ideaal voor orthesenbouw en voetbedden alsook steunzolen -
 Lichte krimp -
 Langdurige schokabsorberende werking -
 Huidvriendelijk -
 Perfecte prijs/kwaliteitsverhouding -

LES AVANTAGES
 Matériel très léger -
 Idéal pour thermoformage entre 90°C et 120°C -
 Rétrécissement léger -
 Fonction antichoc longuement -
 Agréable pour la peau -
 Rapport parfait qualité-prix -

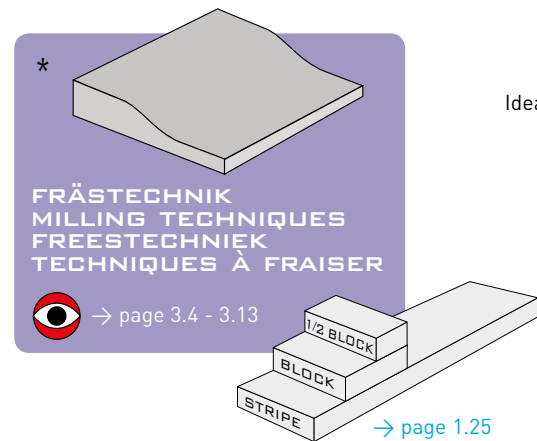

→ part 11

Wir liefern Ihnen diese Platten auch gestanzt in jeder Größe.
We supply all these materials cut in all different sizes.
Deze platen kunnen gestanst worden in alle mogelijke modellen.
Nous fournissons ces plaques dans chaque modèle découpé.

Alle anderen Stärken sind auf Anfrage lieferbar.
All other thicknesses can be delivered on request.
Alle andere diktes leverbaar op aanvraag.
D'autres épaisseurs livrables sur demande.

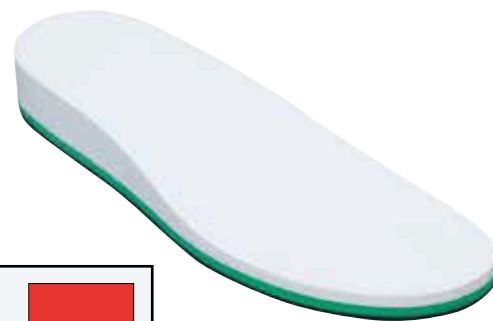

XEM-12
 5/25 Extrafoam sh35 - white
 + Extrafoam sh25 - green - 5mm
 + Extrafoam sh50 - dark blue - 2mm

EXTRAFOAM SOFT, MEDIUM, HARD

06	01	08	05	07	09
weiß white wit blanc	hautfarbe skin colour huidskleur couleur chair	königsblau royal blue koningsblauw bleu royal	dunkelblau dark blue donkerblauw bleu foncé	grün green groen vert	rot red rood rouge
SOFT	SOFT	MEDIUM	HARD		
00	17	04	10		
schwarz black zwart noir	grau grey grijs gris	gelb yellow geel jaune	violett violet violet violet		

Farbabweichungen zwischen dem Farbdruck und dem Originalprodukt sind möglich.
 Colour differences between print and original product are possible.
 Kleurverschillen tussen het drukwerk en het origineel product zijn mogelijk.
 Des différences de couleur entre l'imprimerie et la produit originale sont possible.

EXTRAFOAM SOFT 7011

Dichte 0,15 Gr/cm³
 density 0,15 gr/cm³
 dichtheid 0,15 g/cm³
 densité 0,15 gr/cm³

105 x 95cm

EXTRAFOAM MEDIUM 7012

Dichte 0,21 Gr/cm³
 density 0,21 gr/cm³
 dichtheid 0,21 g/cm³
 densité 0,21 gr/cm³

110 x 95cm

EXTRAFOAM HARD 7013

Dichte 0,38 Gr/cm³
 density 0,38 gr/cm³
 dichtheid 0,38 g/cm³
 densité 0,38 gr/cm³

95 x 95cm

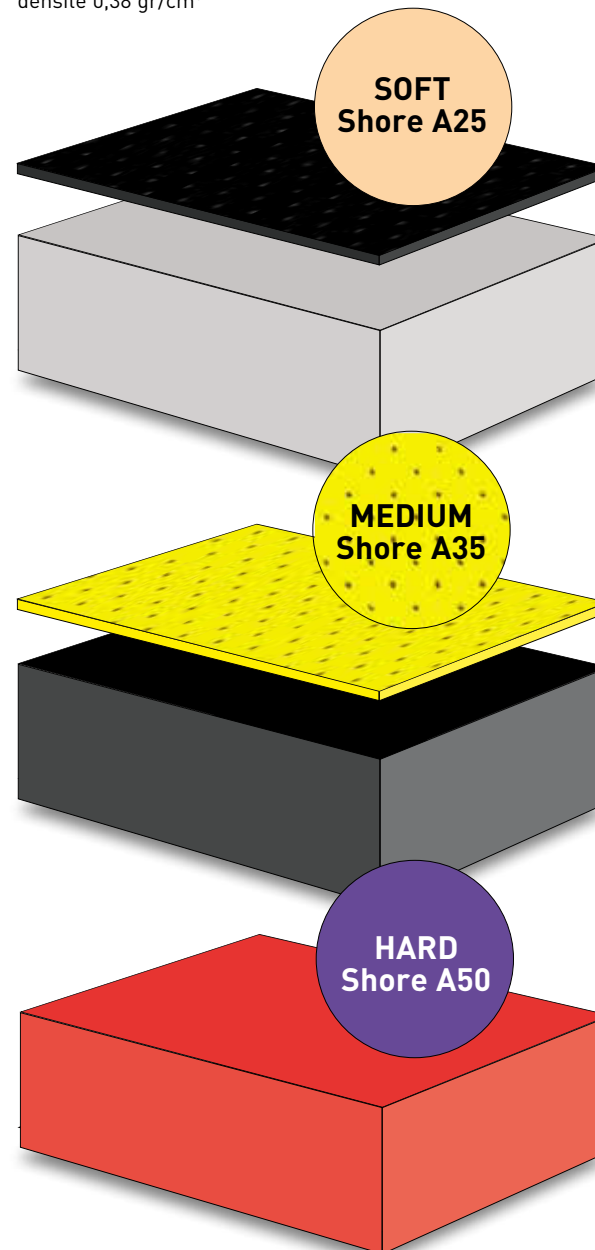

SOFT, MEDIUM, HARD	
0	5
nicht perforiert not perforated niet geperforeerd non perforé	perforiert perforated geperforeerd perforé
Siehe Farbpalette see color palette zie kleurpalet voir palette de couleurs	





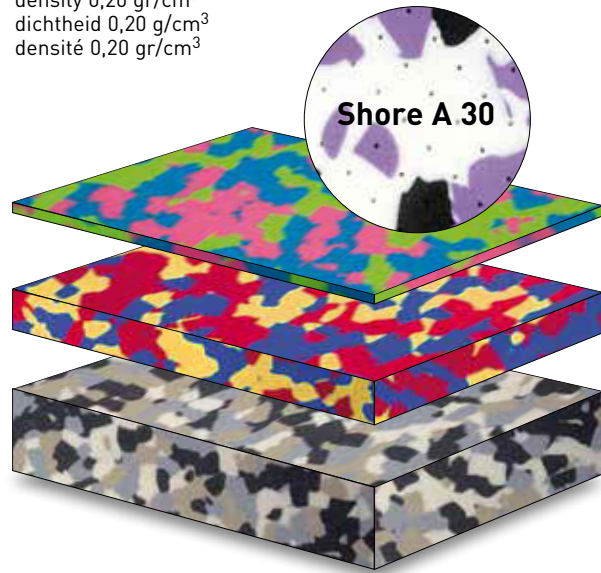

015	1,5 mm	•	•
02	2 mm	•	•
03	3 mm	•	•
04	4 mm	•	•
05	5 mm	•	•
06	6 mm	•	•
07	7 mm	•	
08	8 mm	•	
10	10 mm	•	
12	12 mm	•	
15	15 mm	•	
20	20 mm	•	
25	25 mm	•	
30 *	30 mm	•	

EXTRAFOAM MULTICOLOR 7014.     1

Dichte 0,20 Gr/cm³
density 0,20 gr/cm³
dichtheid 0,20 g/cm³
densité 0,20 gr/cm³

105 x 90cm

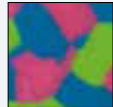

			
11 + black + white + purple	12 + red + green + white + purple	14 + blue + red + yellow + white+black	15 + black + white
			
16 + fuchsie + turquoise + pistache	18 + grey + tierra + eggshell	19 + orange + blue + red	

EXTRAFOAM AQUA 7014.     1

Dichte 0,20 Gr/cm³
density 0,20 gr/cm³
dichtheid 0,20 g/cm³
densité 0,20 gr/cm³

105 x 90cm

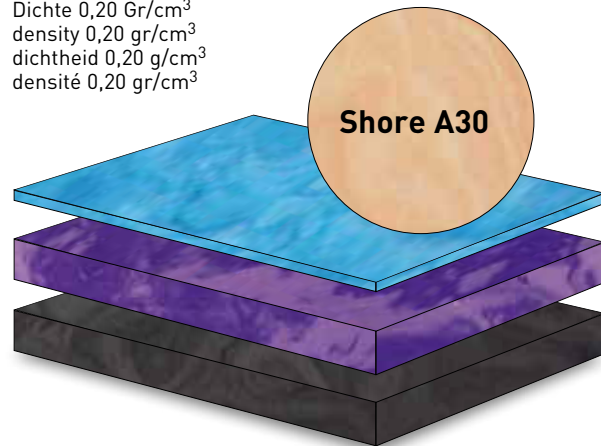





			
30 blau blue blauw bleu	31 beige	32 schwarz black zwart noir	33 purpur purple purper pourpre

EXTRAFOAM MARBLE 7014.     1

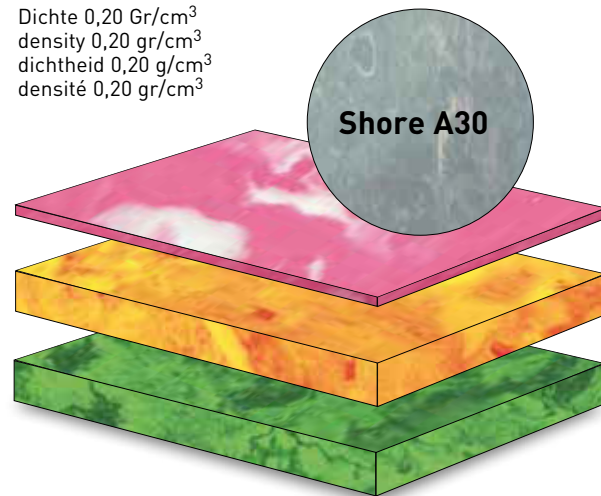
Dichte 0,20 Gr/cm³
density 0,20 gr/cm³
dichtheid 0,20 g/cm³
densité 0,20 gr/cm³

105 x 90cm

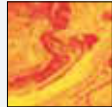

			
35 blau blue blauw bleu	36 grün green groen vert	37 orange orange oranje orange	38 rosa pink roze rose

EXTRAFOAM MULTICOLOR,
AQUA, MARBLE

0	5
nicht perforiert not perforated niet geperforeerd non perforé	perforiert perforated geperforeerd perforé

015>06	1,5 > 6 mm	•	•
07>25	7 > 25 mm	•	
30*	30 mm	•	

 → part 11

Wir liefern Ihnen diese Platten auch gestanzt in jeder Größe.
We supply all these materials cut in all different sizes.
Deze platen kunnen gestanst worden in alle mogelijke modellen.
Nous fournissons ces plaques dans chaque modèle découpé.

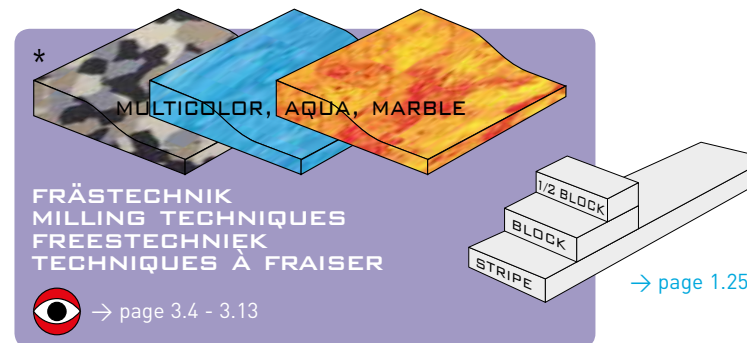



 → page 3.4 - 3.13

→ page 1.25

EVA-MARBLE MINI-ROLLS 7162012.   1

110 x 12cm - 2mm



		
32 schwarz black zwart noir	37 orange orange orange orange	45 marine orange oranje orange

Farbabweichungen zwischen dem Farbdruck und dem Originalprodukt sind möglich.
Colour differences between print and original product are possible.
Kleurverschillen tussen het drukwerk en het origineel product zijn mogelijk.
Des différences de couleur entre l'imprimerie et le produit originale sont possible.

EXTRAGRIP 70150.

- Dichte/density/dichtheid/densité 0,16 Gr/cm³
- Gleitschutz/antiskid/antislip/antidérapant
- Extra elastisch/very Elastic/extra veerkrachtig/très élastique

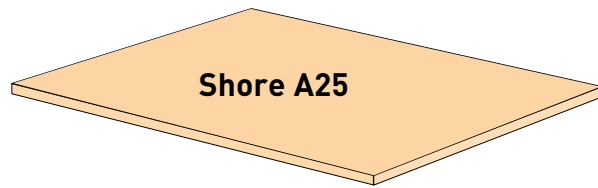

1
hautfarbe
skin colour
huidskleur
couleur chair

015 > 30 1,5 > 30 mm

ELASTOFLEX/HIGHFLEX 7016.

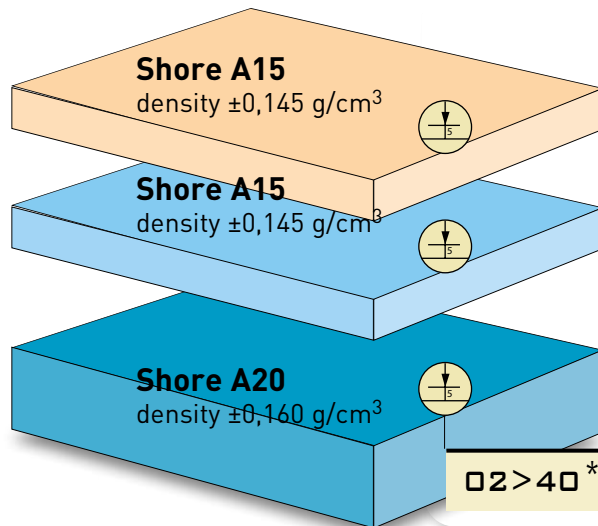

	ELASTO-FLEX	HIGH-FLEX	
	15	20	25
	±0,145 g/cm ³	±0,16 g/cm ³	±0,19 g/cm ³
	101	176	174
	hautfarbe skin colour huidskleur couleur chair	l. blau l. blue l.blauw bleu clair	turquoise turkis
			orange
	02 > 40*	2 > 40 mm	100 x 120cm
			100 x 120cm
			110 x 92cm
			105 x 92cm

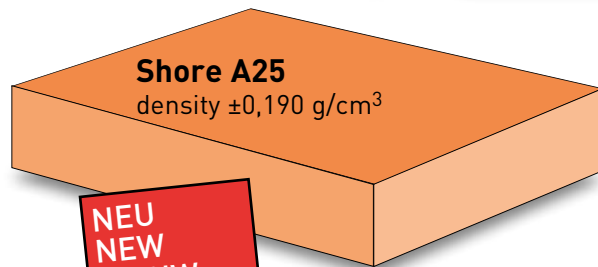

NEU
NEW
NIEUW
NOUVEAU

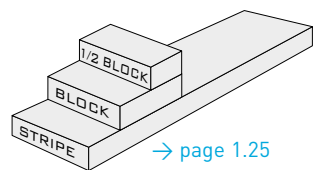

* ELASTOFLEX
HIGHFLEX

FRÄSTECHNIK
MILLING TECHNIQUES
FREESTECHNIEK
TECHNIQUES À FRAISER

→ page 3.4 - 3.13

→ part 11

Wir liefern Ihnen diese Platten auch gestanzt in jeder Größe.
We supply all these materials cut in all different sizes.
Deze platen kunnen gestanst worden in alle mogelijke modellen.
Nous fournissons ces plaques dans chaque modèle découpé.

TERMOLAST 7008.

- Ideal zur thermischen Verformung - Hohe Rückstellkraft, keine Schrumpfung - Sehr leicht zu schleifen
- Perfectly thermo mouldable - Returns to its original form, no shrinking - Very easy to grind
- Ideaal voor thermische vervorming - Zeer goede en langdurige veerkracht - Zeer makkelijk te schuren
- Idéal pour thermoformage - Revient dans sa forme originale, pas de rétrécissement - Facile à verter

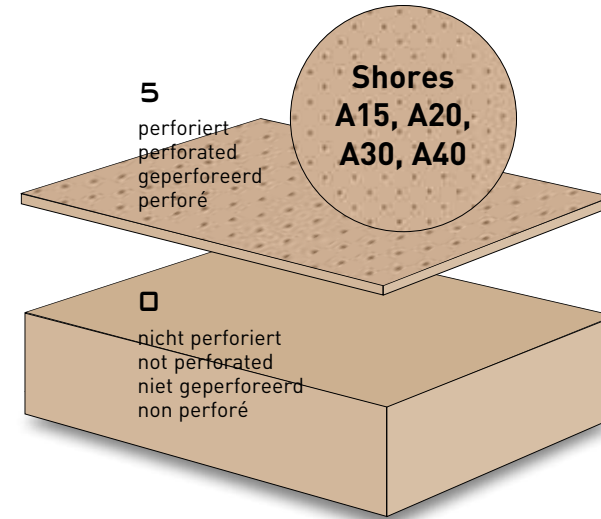

1
hautfarbe
skin colour
huidskleur
couleur chair

	115x115cm	100x75cm	105x87cm	100x82cm
15	A15**	A20**	A30	A40
	sehr weich very soft zeer zacht très douce	sehr weich very soft zeer zacht très douce	weich soft zacht douce	hohe Stabilität very high stability zeer hoge stabiliteit très haute stabilité
05	015 > 1,5 mm			
	06 > 6 mm			
08	08 > 8 mm			
	30* > 30 mm			

*
FRÄSTECHNIK
MILLING TECHNIQUES
FREESTECHNIEK
TECHNIQUES À FRAISER

→ page 3.4 - 3.13

- ** Besonders geeignet für Diabetiker
- Especially for diabetics
- Zeer geschikt voor diabetici
- Spécialement pour diabétique

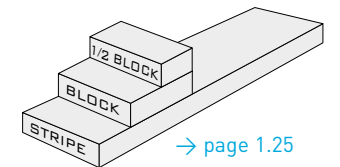

PODOTHERM 7010122.

- VORTEILE
- Abriebwert DIN 100, Dichte 0,45 Gr/cm³
 - Ideal zur thermischen Verformung bis 100°C
 - Äußerst gute Stossdämpfung durch die ideale Mischung von -EVA und Kompaktgummi
- ADVANTAGES
- Abrasion resistance DIN 100, density 0,45 gr/cm³
 - Perfect for thermo moulding up to 100°C
 - Shock absorbing due to the perfect mixture of EVA and Compact rubber

- VOORDELEN
- Slijtweerstand DIN 100, dichtheid 0,45 g/cm³
 - Zeer goed thermisch vervormbaar tot 100°C
 - Zeer langdurige schokabsorberende werking, door de ideale EVA/compact rubber-mengeling

- AVANTAGES
- Résistance à l'abrasion DIN 100, densité 0,45 gr/cm³
 - Idéal pour thermoformage depuis 100°C
 - Choc absorbant à cause du mélange parfait de EVA et Compact caoutchouc

Farbabweichungen zwischen dem Farbdruck und dem Originalprodukt sind möglich.
Colour differences between print and original product are possible.
Kleurverschillen tussen het drukwerk en het origineel produkt zijn mogelijk.
Des différences de couleur entre l'imprimerie et la produit originale sont possible.

Shore A50

130 x 80cm

dunkelbeige
dark beige
donkerbeige
beige foncé

015	1,5 mm	•
02 > 08	2 > 8 mm	•
10	10 mm	•
15	15 mm	•
20	20 mm	•

FORMLUX 7017.



110 x 110cm

- Dichte 0,14 Gr/cm³
- 100 % schrumpffrei bei Erwärmung; Verformungstemperatur bei ca. 130°C
- Anwendungsgebiet: Orthesenbau, Prothesenbau und Einlagen.
- Density 0,14 gr/cm³
- 100 % shrink resistance to heat, thermo mouldable at ca. 130°C
- Used for construction of orthoses, prosthesis and orthopaedic foot supports.
- Dichtheid 0,14 g/cm³
- 100 % krimpvrij bij verwarming, vervormingtemperatuur bij ca. 130°C
- Toepassingsgebied: orthesenbouw, prothesenbouw en steunzolen.
- Densité 0,14 gr/cm³
- 100 % irrétrécissable pendant chauffage, temp. de thermoformage à 130°C
- Pour la construction des orthèses, prothèses et semelles orthopédiques.

	0	5
	nicht perforiert not perforated niet geperforeerd non perforé	perforiert perforated geperforeerd perforé
	8 Farben 8 colours 8 kleuren 8 couleurs	8 Farben 8 colours 8 kleuren 8 couleurs



02	2 mm		
>	>	•	•
06	6 mm		
08	8 mm	•	
>	>		
36	36 mm		

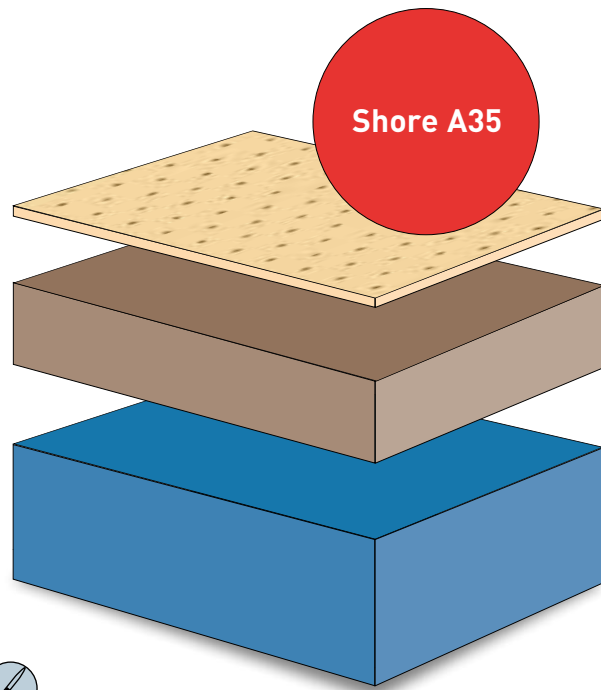

06	01	02	04	07	08	09	00
weiß white wit blanc	hautfarbe skin colour huidskleur couleur chair	braun brown bruin	gelb yellow geel jaune	grün green groen vert	königsblau royal blue koningsblauw bleu royal	rot red rood rouge	schwarz black zwart noir

Farbabweichungen zwischen dem Farbdruck und dem Originalprodukt sind möglich.
Colour differences between print and original product are possible.
Kleurverschillen tussen het drukwerk en het origineel product zijn mogelijk.
Des différences de couleur entre l'imprimerie et la produit originale sont possible.



Wir liefern Ihnen diese Platten auch gestanzt in jeder Größe.
We supply all these materials cut in all different sizes.
Deze platen kunnen gestanst worden in alle mogelijke modellen.
Nous fournissons ces plaques dans chaque modèle découpé.

Alle anderen Stärken sind auf Anfrage lieferbar.
All other thicknesses can be delivered on request.
Alle andere diktes leverbaar op aanvraag.
D'autres épaisseurs livrables sur demande.

EVAZOTE 7019.017.



Shore A10

200 x 100cm (grey)

PLASTAZOTE 7009.



Shore A15

200 x 100cm

- Dichte 0,045 Gr/cm³
- Verformungstemperatur bei ca. 160°C
- weltberühmtes Polstermaterial für Prothesen und Orthesen.
- density 0,045 gr/cm³
- Thermo mouldable at ca. 160°C
- World-famous padding material for prosthesis and orthoses.
- dichtheid 0,045 g/cm³
- Vervormingtemperatuur bij ca. 160°C
- Wereldberoemd polstermateriaal voor prothesen en orthesen.
- densité 0,045 gr/cm³
- Température de thermoformage à 160°C
- Matériel de rembourrage réputé dans le monde entier pour prothèses et orthèses.

	PLASTAZOTE		EVAZOTE
	0	5	0
	6 Farben 6 colours 6 kleuren 6 couleurs	6 Farben 6 colours 6 kleuren 6 couleurs	17 grau grey grijs gris



02	2 mm	•	•	•
03	3 mm	•	•	•
04	4 mm	•	•	•
05	5 mm	•	•	•
06	6 mm	•	•	•
08	8 mm	•		•
10	10 mm	•		•
12	12 mm	•		•
15	15 mm	•		•
20	20 mm	•		•
25	25 mm	•		•
30	30 mm	•		•

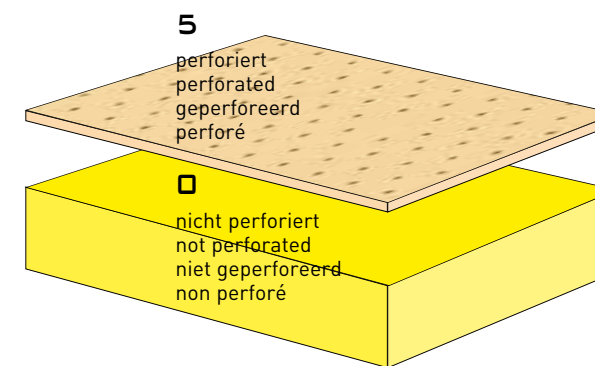

EVAZOTE, PLASTAZOTE

06	01	04	08	09	00	17
weiß white wit blanc	hautfarbe skin colour huidskleur couleur chair	gelb yellow geel jaune	königsblau royal blue koningsblauw bleu royal	rot red rood rouge	schwarz black zwart noir	grau grey grijs gris

EVACAD 714.



Shore	Density g/cm ³	Dimensions	015 > 10	30*	35*	40*
			1,5 > 10mm	30mm	35mm	40mm
25	±0,140	99x118 cm				09 15
30	±0,160	115x97cm		87 98		09 76 87 78 98
35	±0,185	107x92cm		09		81
40	±0,190	107x92cm		21 81 09	21	21 76 81 78 09 15
45	±0,230	104x90cm				46 71
50	±0,270	100x88cm		28 81 78 46	28	28 21 81 78 01 14 06
60	±0,370	90x80cm		46 78 81	29 78 85	
70	±0,425	84x74cm	81	81		

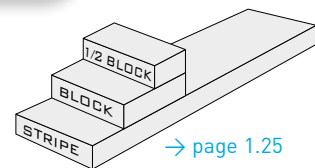
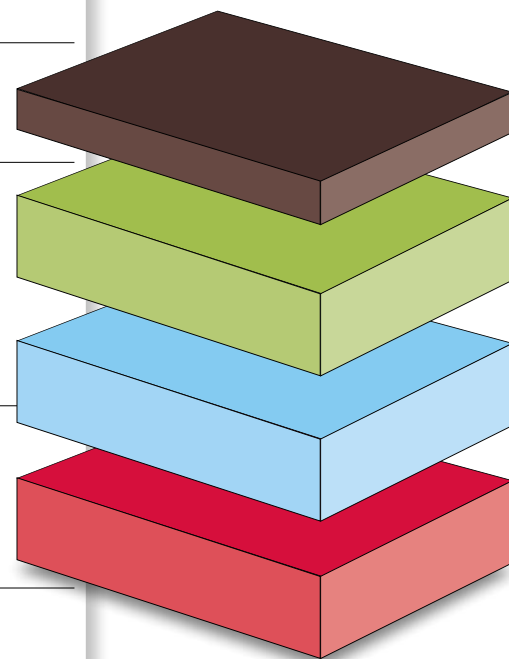

→ page 1.25

EVASTAT 715.

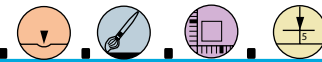

Shore	Density g/cm ³	Dimensions	6	8	10	15	20	30*	35*	40*
			6mm	8mm	10mm	15mm	20mm	30mm	35mm	40mm
30	±0,160	115 x97cm	09	09	09	09	09	09	09	09
35	±0,185	110x95cm								81
40	±0,190	107 x92cm							89	89
45	±0,230	104x90cm	09 81 87	09 81 87	09 81 87	09 81 87	09 81 87	09 81 87		09 81 87
50	±0,270	100x88cm								87
60	±0,370	93x82cm	09 81 87	09 81 87	09 81 87	09 81 87	09 81 87	09 81 87		

VORTEILE

- Besonderes geeignet für das CAD-CAM Fräsen von Einlagen auf grund seiner antidust Eigenschaft
- Staubpartikel laden sich nicht statisch auf (erhöht die Absaugkapazität)

ADVANTAGES

- Especially suitable for the CAD-CAM milling of orthopaedic foot supports due to its antidust characteristics
- No static loading of dust particles (eases the suction capacity)

VOORDELEN

- Uitermate geschikt voor het CAD-CAM freezen van steunzolen vanwege antidust eigenschappen
- Stofdeeltjes laden zich niet statisch op (vergemakkelijkt de afzuigcapaciteit)

LES AVANTAGES

- Hautement qualifié pour fraiser les semelles CAD-CAM à cause des caractéristiques 'antidust'
- Grain de poussière ne se charge pas statiquement (facilite la capacité d'aspiration)

* 

FRÄSTECHNIK
MILLING TECHNIQUES
FREESTECHNIEK
TECHNIQUES À FRAISER

→ page 3.4 - 3.13

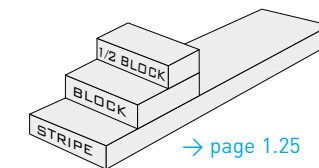

→ page 1.25

Alle anderen Stärken sind auf Anfrage lieferbar.
All other thicknesses can be delivered on request.
Alle andere diktes leverbaar op aanvraag.
D'autres épaisseurs livrables sur demande.

EVACAD, EVASTAT

109	114	115	189	121	128	129	181	187	101	198	146	171	176	178	106
weiß white wit blanc	elfenbein ivory ivoor	beige beige beige	arena	hellgrau light grey lichtgrijs gris clair	dunkelgrau dark grey donkergrijs gris foncé	anthrazit anthracite antraciet anthracite	schwarz black zwart noir	tierra	hautfarbe skin huidskleur couleur chair	otter otter loutre otter	dunkelbraun dark brown donkerbruin brun foncé	pistache	hellblau light blue lichtblauw bleu clair	dunkelblau dark blue donkerblauw bleu foncé	rot red rood rouge

Farbabweichungen zwischen dem Farbdruck und dem Originalprodukt sind möglich.
 Colour differences between print and original product are possible.
 Kleurverschillen tussen het drukwerk en het origineel product zijn mogelijk.
 Des différences de couleur entre l'imprimerie et la produit originale sont possible.

EVA CARBOSTAT 718.

Antistatisches Material ist perfekt geeignet für Arbeitsschuhe und entspricht folgende Anforderungen:
Antistatic material suitable for conductive footwear, meets following requirements:
Antistatisch materiaal geschikt voor werkschoenen, voldoet aan volgende normen:
Ce matériel antistatique est qualifié pour des chaussures de travail aux normes suivantes:

Electrical resistance of Conductive Footwear
DIN EN ISO 20345ff
- parameter: Electrical Resistance [3.14]
- Unit: Ohm
- Result: $3,0 \times 10^3$
- Requirement: $\leq 10^5$
PFI report on request.

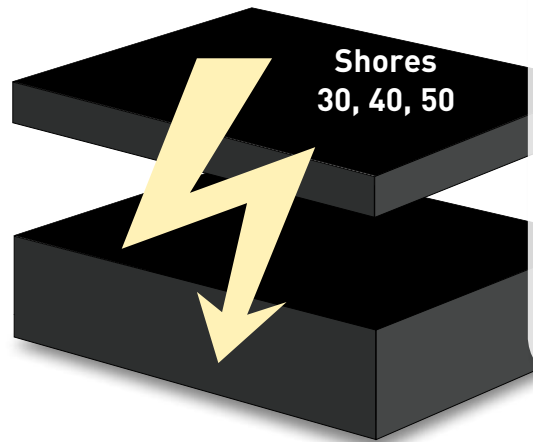

Shore	Dimensions	6mm	8mm	10mm	15mm	20mm	30mm*	40mm*
30	114x95cm	81	81	81	81	81		81
40	102x88cm	81	81	81	81	81	81	81
50	88x85cm	81	81	81	81	81		81

EVA MARBLE 716.

Shore	Density g/cm³	Dimensions	015	02	03	04	05	40*
			1,5mm	2mm	3mm	4mm	5mm	40mm
40	±0,190	107x92cm						38 32 45 48
50	±0,270	100x87cm	38	38	38	38	38	38
			45	45	45	45	45	45

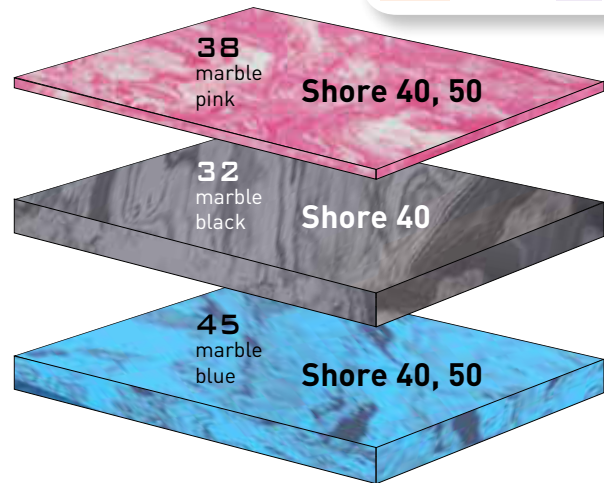

Alle anderen Stärken sind auf Anfrage lieferbar.
All other thicknesses can be delivered on request.
Alle andere diktes leverbaar op aanvraag.
D'autres épaisseurs livrables sur demande.



EVA CORK 717.000.

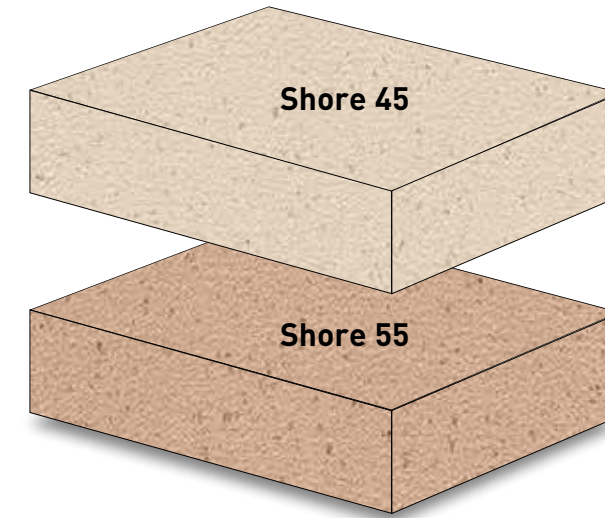

		45	55
		104x90cm	95x84cm
02	2 mm	•	•
03	3 mm	•	•
04	4 mm	•	•
05	5 mm	•	•
06	6 mm	•	•
08	8 mm	•	•
10	10 mm	•	•
12	12 mm	•	•
15	15 mm	•	•
20	20 mm	•	•
30*	30 mm	•	•
40*	40 mm	•	•

EVA CARBOSTAT, EVA MARBLE, EVA CORK

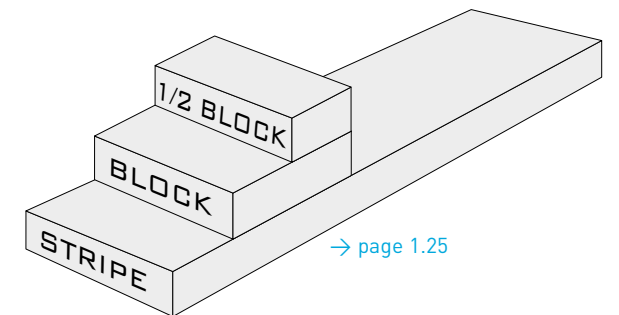
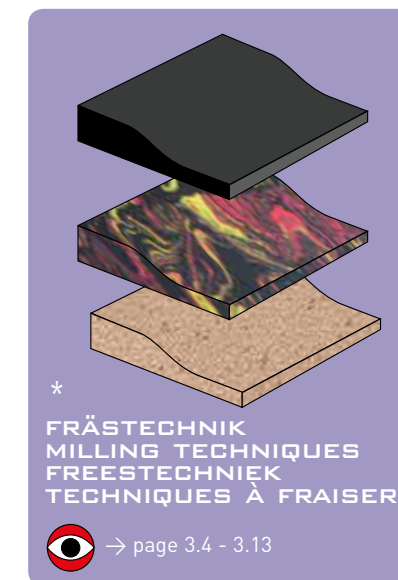

Farbabweichungen zwischen dem Farbdruck und dem Originalprodukt sind möglich.
Colour differences between print and original product are possible.
Kleurverschillen tussen het drukwerk en het origineel product zijn mogelijk.
Des différences de couleur entre l'imprimerie et la produit originale sont possible.



KEILE
STRIPES
STROKEN
BANDES

BLOCK
BLOCK
BLOK
BLOC

1/2 BLOCK
1/2 BLOCK
1/2 BLOK
1/2 BLOC

→ part 1

UNI-FORM

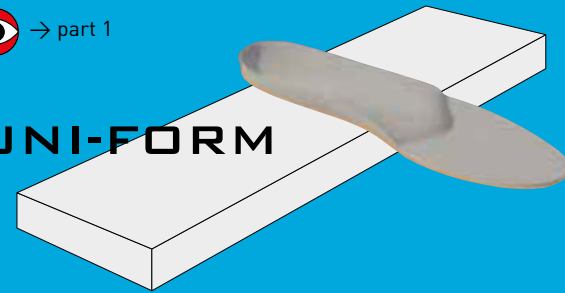

STANDARD*: 35 x 25 cm

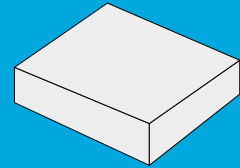

STANDARD*: 31 x 12,5 cm
35 x 13 cm

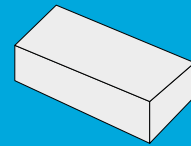

	15mm	20mm	25mm	30mm	35mm	40mm
shore	20→60	20→60	20→60	20→70	20→60	20→60

→ page 3.4 - 3.13

ORTHO-FORM



STANDARD*: 35 x 25 cm

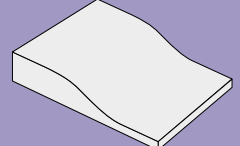

STANDARD*: 31 x 12,5 cm
35 x 13 cm

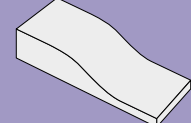

COMBI-FORM

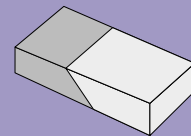
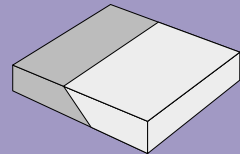

* andere Abmessungen sind möglich
other dimensions are possible
andere afmetingen zijn mogelijk
autres dimensions sont possibles

EVACAD

	30mm → 5/25	40mm → 10/30	35mm → 8/27
Shore			
30	•	•	
35		•	
40	•	•	
45	•	•	
50	•	•	
60	•		•

EVASTAT

	30mm → 5/25	40mm → 10/30
Shore		
30	•	•
35		•
40		•
45	•	•
50		•
60	•	

Shore70 - 30mm: only UNIFORM

EVA CARBOSTAT

	30mm → 5/25	40mm → 10/30
Shore		
30		•
40	•	•
50		•

EVA MARBLE

	40mm → 10/30
Shore	
40	•
50	•

EVA CORK

	30mm → 5/25	40mm → 10/30
Shore		
45	•	•
55	•	•

IT-AIR CORK HARD 70010.



1

142 x 92cm



IT-AIR CORK SOFT 70011.



1

155 x 95cm



IT-AIR CORK

VORTEILE

- EVA/Kork Mischung, sehr leicht, keine Schrumpfung
- Perfekt geeignet zur thermischen Verformung (ca. 100°C)
- Anwendung für Orthesenbau und Einlagen

ADVANTAGES

- EVA/cork mixture, very light, no shrinkage
- Perfect for thermo moulding (ca. 100°C)
- For the construction of orthoses, insoles and orthopaedic foot supports

VOORDELEN

- EVA/kurk mengeling, zeer licht, geen krimp
- Perfect thermisch vervormbaar (ca. 100°C)
- Toepassingen: orthesenbouw en steunzolen

AVANTAGES

- Mélange EVA/liège, très léger, pas de rétrécissement
- Idéal pour thermoformage (ca. 100°C)
- Pour la construction des orthèses et semelles orthopédiques



→ part 11

Wir liefern Ihnen diese Platten auch gestanzt in jeder Größe.
We supply all these materials cut in all different sizes.
Deze platen kunnen gestanst worden in alle mogelijke modellen.
Nous fournissons ces plaques dans chaque modèle découpé.

Alle anderen Stärken sind auf Anfrage lieferbar.
All other thicknesses can be delivered on request.
Alle andere diktes leverbaar op aanvraag.
D'autres épaisseurs livrables sur demande.

MICRO CORK ECO HARD 70012.



1

95 x 77cm

VORTEILE:

- EVA/Kork Mischung, sehr leicht, keine Schrumpfung
- Perfekt geeignet zur thermischen Verformung (ca. 100°C)
- Anwendung für Orthesenbau und Einlagen
- Sehr preiswert

ADVANTAGES:

- EVA/cork mixture, very light, no shrinkage
- Perfect for thermo moulding (ca. 100°C)
- For the construction of orthoses, insoles and orthopaedic foot supports
- Best value for money

VOORDELEN:

- EVA/kurk mengeling, zeer licht, geen krimp
- Perfect thermisch vervormbaar (ca. 100°C)
- Toepassingen: orthesenbouw en steunzolen
- Zeer prijsgunstig

AVANTAGES

- Mélange EVA/liège, très léger, pas de rétrécissement
- Idéal pour thermoformage (ca. 100°C)
- Pour la construction des orthèses et semelles orthopédiques
- Très avantageux

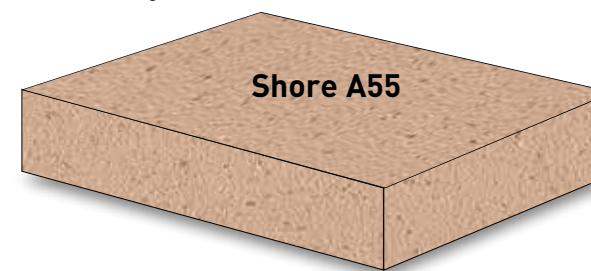

→ part 11

Wir liefern Ihnen diese Platten auch gestanzt in jeder Größe.
We supply all these materials cut in all different sizes.
Deze platen kunnen gestanst worden in alle mogelijke modellen.
Nous fournissons ces plaques dans chaque modèle découpé.

Alle anderen Stärken sind auf Anfrage lieferbar.
All other thicknesses can be delivered on request.
Alle andere diktes leverbaar op aanvraag.
D'autres épaisseurs livrables sur demande.

Farbabweichungen zwischen dem Farbdruck und dem Originalprodukt sind möglich.
 Colour differences between print and original product are possible.
 Kleurverschillen tussen het drukwerk en het origineel product zijn mogelijk.
 Des différences de couleur entre l'imprimerie et le produit originale sont possible.

		70012	
		Eco hart Eco hard Eco hard Eco dur	
015	1,5 mm	•	
02	2 mm	•	
03	3 mm	•	
04	4 mm	•	
05	5 mm	•	
06	6 mm	•	
08	8 mm	•	
10	10 mm	•	
12	12 mm	•	
15	15 mm	•	
20	20 mm	•	
30	30 mm	•	

PRESSKORK P-25 70020.



100 x 50cm

Nicht thermisch verformbar - flexibel und sehr leicht - sehr preiswert
Not thermo mouldable - flexible and very light material - best value for money
Niet thermisch vervormbaar - flexibel en zeer licht - zeer prijsgunstig
Pas de thermoformage - flexible et très léger - très avantageux



NATURKORK 70013.



100 x 50cm

Nicht thermisch verformbar - flexibel und sehr leicht
Not thermo mouldable - flexible and very light material
Niet thermisch vervormbaar - flexibel en zeer licht
Pas de thermoformage - flexible et très léger



		70013 Naturkork natural cork natuurkurk liège naturel	70020 Presskork press cork perskurk liège aglom.
015	1,5 mm	•	•
02	2 mm	•	•
03	3 mm	•	•
04	4 mm	•	•
05	5 mm	•	•
06	6 mm	•	•
08	8 mm	•	•
10	10 mm	•	•
12	12 mm	•	•
15	15 mm	•	•
20	20 mm	•	•
25	25 mm	•	•
30	30 mm	•	•
60	60 mm	•	



→ part 11

Wir liefern Ihnen diese Platten auch gestanzt in jeder Größe.
We supply all these materials cut in all different sizes.
Deze platen kunnen gestanst worden in alle mogelijke modellen.
Nous fournissons ces plaques dans chaque modèle découpé.

Alle anderen Stärken sind auf Anfrage lieferbar.
All other thicknesses can be delivered on request.
Alle andere diktes leverbaar op aanvraag.
D'autres épaisseurs livrables sur demande.

NATURKORK 70022.



Roll/roll/rol/rouleau 100cm



		70022 Naturkork auf Rolle natural cork on roll natuurkurk op rol liège naturel en rouleau
30	3 mm x 51 m	•
50	5 mm x 31 m	•

LATEXKORK 70019.



90 x 60cm

Sehr elastisch und flexibel
Very elastic and flexible
Zeer hoog elastisch en soepel
Très élastique et souple



RL105 GUMMIKORK 70015.



100 x 50cm



AB GUMMIKORK 70018.



91 x 45cm



VORTEILE

- Leistenkork, stark mit Latex gebunden, flexibel und abriebfest
- Leicht zu verarbeiten und stabil
- Hohes spezifisches Gewicht
- Nicht thermisch verformbar

ADVANTAGES

- Cork for lasts, combined with latex, flexible and high resistant
- The material is easy to process and stable
- Heavy specific gravity
- Not thermo mouldable

VOORDELEN

- Leestenkurk, zeer sterk latexgebonden, flexibel en slijtvast
- Zeer goed verwerkbaar en stabiel
- Hoog soortelijk gewicht
- Niet thermisch vervormbaar

AVANTAGES

- Liège pour forme, combiné avec latex, flexible et résistant
- Traitement facile, produit extrêmement stable
- Poids spécifique lourd
- Pas de thermoformage

		70019 Latexkork latex cork moussekurk liège mousse	70015 RL105	70018 AB
015	1,5 mm	•	•	•
02	2 mm	•	•	•
03	3 mm	•	•	•
04	4 mm	•	•	•
05	5 mm	•	•	•
06	6 mm	•	•	•
08	8 mm	•	•	•
10	10 mm	•	•	•
12	12 mm	•		
15	15 mm	•	•	•
20	20 mm	•	•	•

Farbabweichungen zwischen dem Farbdruck und dem Originalprodukt sind möglich.
Colour differences between print and original product are possible.
Kleurverschillen tussen het drukwerk en het origineel product zijn mogelijk.
Des différences de couleur entre l'imprimerie et la produit originale sont possible.

☐ = eine Seite klebend
= preglued one side
= enkelzijdig voorgelijmd
= précollé une façade

THERMO 70040.

Hartes Zwischensohlenmaterial für Einlagen
Hard innersole material for inlays
Hard tussenmateriaal voor steunzolen
Intercalaire dur pour semelles orthopédique

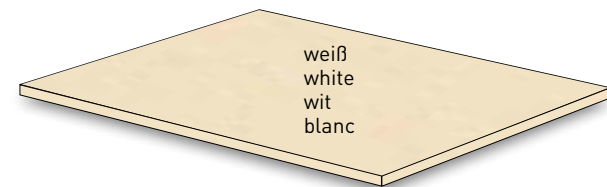

		100 x 135 cm	100 x 140 cm
09	0,9 mm		•
12	1,2 mm	•	
15	1,5 mm		•
17	1,75 mm		•

THERMO PLUS 70043.

Extrem hartes Material mit extra inkorporierter Struktur, eine Seite klebend
Extremely hard material with extra-incorporated structure, preglued one side
Extreem hard materiaal met extra geweve structuur, enkelzijdig voorgelijmd
Matériel extrêmement dur avec structure supplémentaire incorporé, précollé une façade

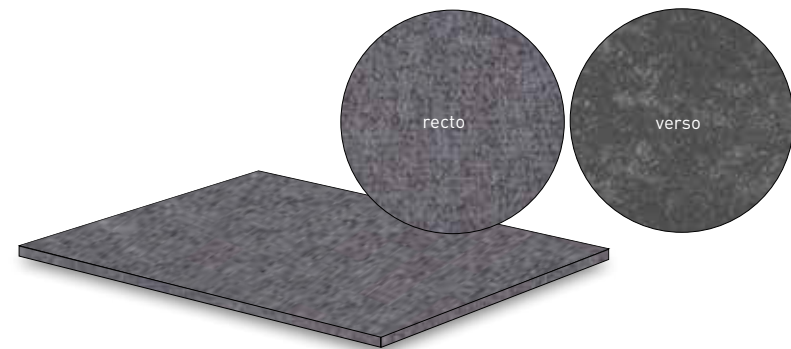

16	1,6 mm	•
20	2,0 mm	•

THERMO ANTRACITE 70044.

Sehr hartes Material, hohe Stabilität, eine Seite klebend
Very hard material, high stability, preglued one side
Zeer hard, extra stabiliteit, enkelzijdig voorgelijmd
Matériel très dur, haute stabilité, précollé une façade

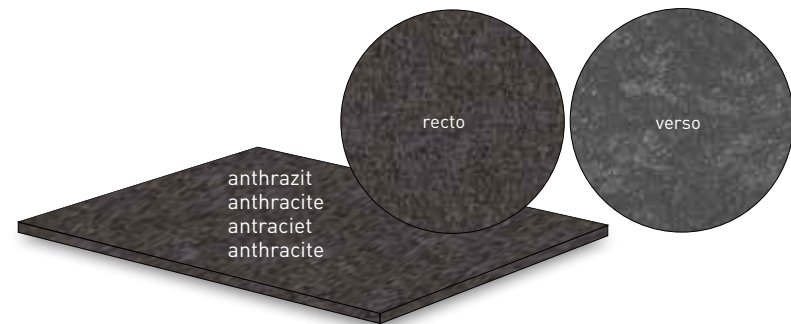

14	1,4 mm	•
21	2,1 mm	•

→ part 11

**Wir liefern Ihnen diese Platten auch gestanzt in jeder Größe.
We supply all these materials cut in all different sizes.
Deze platen kunnen gestanst worden in alle mogelijke modellen.
Nous fournissons ces plaques dans chaque modèle découpé.**

☐ = Doppelseitig klebend
= preglued both sides
= dubbelzijdig voorgelijmd
= précollé deux façes

EXTRAFLEX 70046.

Sehr stabiles Versteifungsmaterial, doppelseitig klebend; hervorragend zu schleifen. Speziell für Orthesen, Hinterkappen und Schäfte.

Very stable stiffening tissue, preglued both sides; perfectly grindable and glueable. Specifically for orthosis, counters and shafts.

Zeer stabiel verstijvingmateriaal, dubbelzijdig voorgelijmd; zeer goed slijpbaar. Specifiek voor orthesen, contreforts en schachten.

Matériel de renforcement très stable, précollé deux façes; très facile à polir. Spécifiquement pour orthèses, contreforts et tiges.

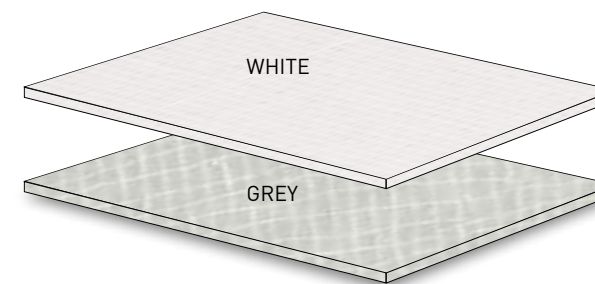

		6 WHITE	8 GREY
06	0,6 mm	•	
08	0,8 mm	•	•
10	1,0 mm	•	
12	1,2 mm	•	•
14	1,4 mm	•	•
16	1,6 mm	•	
18	1,8 mm	•	•

MULTIFLEX BLUE 700488.

Extraflex

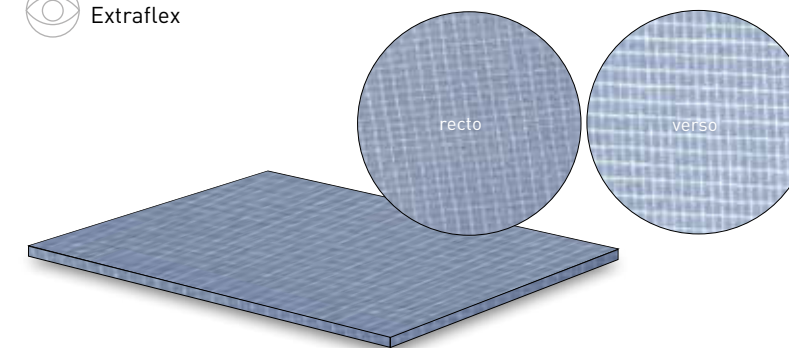

09	0,9 mm	•
13	1,3 mm	•

MAX GROEN 70049.

Extraflex

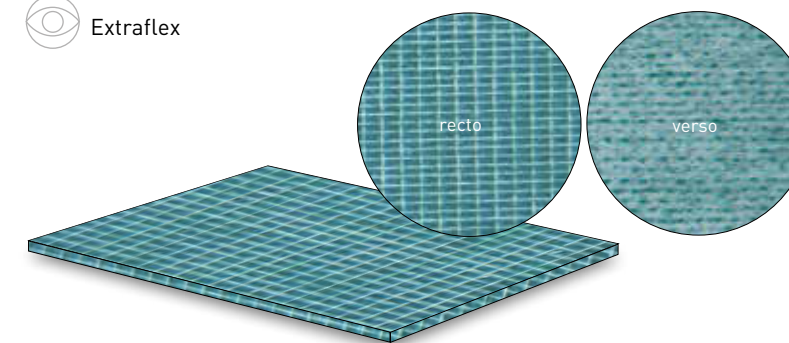

11	1,1 mm	•
15	1,5 mm	•





Farbabweichungen zwischen dem Farbdruck und dem Originalprodukt sind möglich.
Colour differences between print and original product are possible.
Kleurverschillen tussen het drukwerk en het origineel product zijn mogelijk.
Des différences de couleur entre l'imprimerie et la produit originale sont possible.

☐ = eine Seite klebend
= preglued one side
= enkelzijdig voorgelijmd
= précollé une face

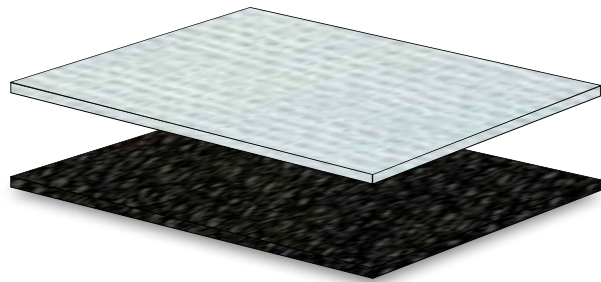
COVER BLACK OR BLUE 70041.   1

Sehr dünnes und flexibles Verstärkungsmaterial für Vorderkappen von Schuhen.
Very thin and flexible stiffening material for toe caps.
Zeer dun flexibel verstijvingmateriaal voor neuzen van schoenen.
Matière de renforcement très fin, flexible pour bouts de chaussures.





	0	8
	BLACK	BLUE
	100 x 150cm	100 x 150cm
70 0,70 mm 	•	
75 0,75 mm 		•
85 0,85 mm 		•
95 0,95 mm 		•

COVER PLUS 70042.   1

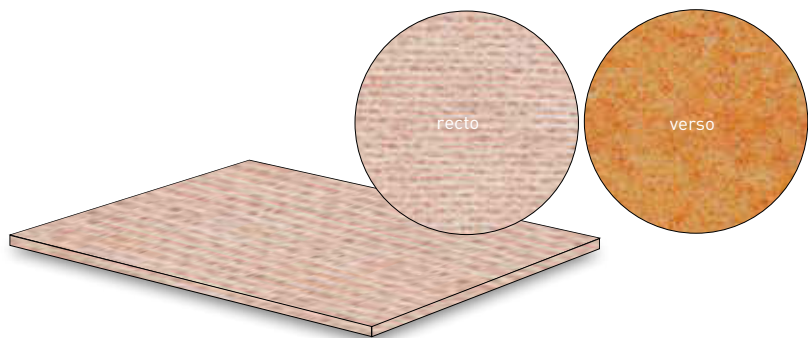
Sehr dünnes und flexibles Verstärkungsmaterial für Vorderkappen von Schuhen.
Very thin and flexible stiffening material for toe caps.
Zeer dun flexibel verstijvingmateriaal voor neuzen van schoenen.
Matière de renforcement très fin, flexible pour bouts de chaussures.





10 1 mm 	•
17 1,7 mm 	•

DUROFLEX (COMBI) 70045.   1

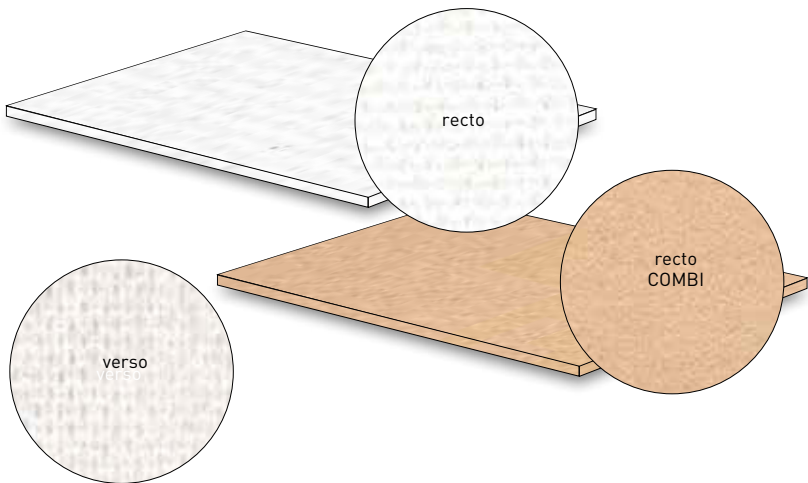
Relativ flexibel, gute Stabilität, eine Seite klebend
Relatively flexible, good stability, preglued one side
Relatief flexibel, goede stabiliteit, enkelzijdig voorgelijmd
Relativement flexible, bonne stabilité, précollé une face



12 1,2 mm 	•	1,50 m ²
19 1,9 mm 	•	1,50 m ²

COMBI:
Mit einer Extraschicht Viledon
With extra viledon layer
Met extra viledon laag
Avec couche viledon supplémentaire

KAPPEN 7004NCO.   25p

COVER BLUE
KAPPEN
TOEPUFF
NEUS
REINFORCEMENT

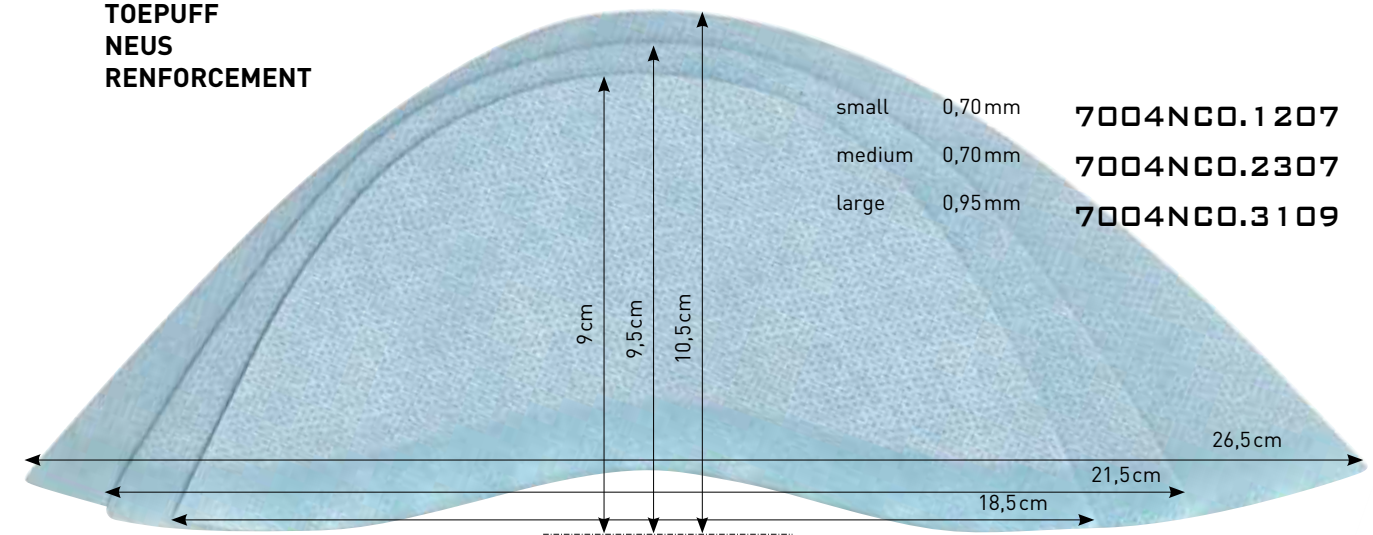

CONTREFORT 7004CF.   25p

FLEX WHITE
FERSENKAPPEN
COUNTER WHITE
CONTREFORT
REINFORCEMENT

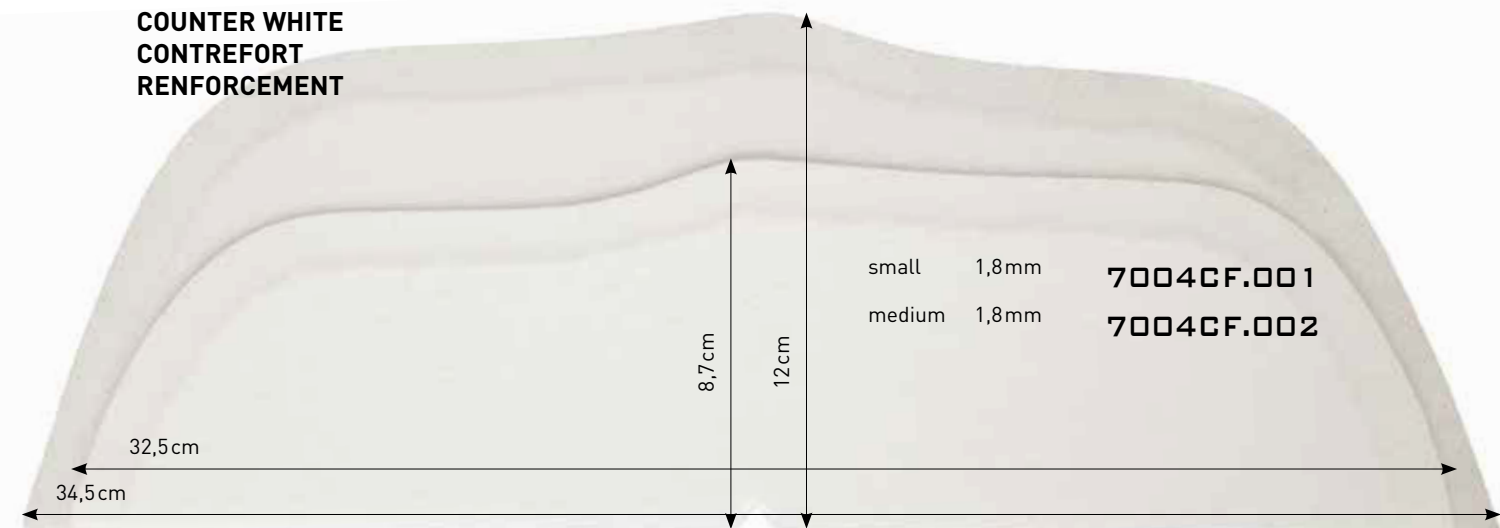

SK25 SYNTAX 70047.   1

Synthetisches Innenschuhmaterial, nicht klebend
Synthetic insole material, without glue
Synthetisch binnenzool materiaal, niet voorgelijmd
Première synthétique, sans colle

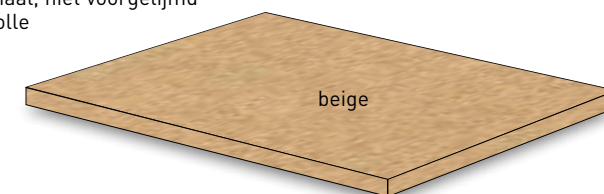

25 2,5 mm	•
------------------	---

Farbabweichungen zwischen dem Farbdruck und dem Originalprodukt sind möglich.
Colour differences between print and original product are possible.
Kleurverschillen tussen het drukwerk en het origineel product zijn mogelijk.
Des différences de couleur entre l'imprimerie et la produit originale sont possible.

Exclusive supplier of the only original PPT for Europe



das einzige original PPT®

- PU Schaumstoff, offen Zellular
- Niedrige Densität
- Medisch geprüft
- Extrem hohe Rückstellkraft, nicht thermisch verformbar
- PPT® normal in blau oder hautfarbe, Slow Recovery in orange
- In 1,6 und 3,2mm; Normal PPT® auch in 4,5 - 6,4 - 9,5mm.

USAGE

- extrem gute hohe Stossdämpfung; extrem hohe Rückstellkraft.
- Einfach zu verarbeiten, nicht thermisch verformbar
- Leicht gewicht
- Abwaschbar
- Verbesserte Reissfestigkeit und Leistungsfähig
- Schützt der Patient im Bereich von Prothesen, Orthesen und jede andere orthopaedische Anwendung
- Porös: behaltet die Haut trocken, frisch und gibt Bequemlichkeit

de enige originele PPT®

- Polyurethaan open cellulaire structuur
- Lage densiteit
- Medisch getest
- Goed materiaalgeheugen voorkomt thermoforming
- In blauw of huidskleur; Slow Recovery in oranje
- In 1,6 en 3,2mm; gewone PPT® ook in 4,5 - 6,4 - 9,5mm

GEBRUIK

- Uitzonderlijke schokdempende eigenschappen; komt altijd naar zijn oorspronkelijke vorm terug.
- Eenvoudig te verwerken. niet thermisch vervormbaar
- Lichtgewicht
- Afwasbaar
- Verbeterde draag- en scheurbestendigheid
- Beschermt de patient bij dragen van prothese of orthese etc.
- Poreus: houdt de huid droog, fris en geeft comfort

the only original PPT®

- Open cell frothed polyurethane
- Low density
- Medical grade
- Good memory prevents thermoforming
- In blue or skin colour; Slow Recovery in orange
- In 1,6 and 3,2mm; regular PPT® also in 4,5 - 6,4 - 9,5mm

USE

- Exceptional shock attenuating properties; always returns to its original form.
- Easy to manipulate, not thermo mouldable
- Lightweight
- Washable
- Improved wear and tear characteristics
- Patient protection in orthoses, prostheses, orthopaedic appliances
- Porous to help skin remain dry, cool and comfortable

le seul PPT® original

- Polyurethane structure cellulaire ouverte
- Densité basse
- Testé médicale
- Bonne mémoire, prévient thermoformage
- En bleu ou couleur chair.
- Mémoire lente (Slow Recovery) en orange
- PPT® normal en 1,6mm - 3,2mm - 4,5mm - 6,4mm - 9,5mm

USAGE

- Caractéristiques anti-chock exceptionnelles; revient toujours à sa forme initiale
- Facilement à manipuler; pas thermoformable
- Poids léger
- Lavable
- Qualité déchirure et portée amélioré
- Protection pour le patient en orthèse, prothèse ainsi que chaque application orthopédique
- Poreux: aide la peau à rester sec, frais et confortable

Professional Protective Technology

ROLLEN ROLLS ROLLEN ROULEAUX



glatt/rauh
smooth/abraded
glad/ruw
lisse/rugueux



beidseitig gerauht
abraded/abraded
beide zijden ruw
les deux côtés rugueux



rauh/PE-Schicht
abraded/PE-mesh
ruw/PE-gaas
rugueux/tissue en PE

PPT 70055.0.

	□	□				
		1	2	3	4	
	not perforated not perforated geperforeerd niet non perforé	hautfarbe tan huidskleur couleur chair	hautfarbe tan huidskleur couleur chair	blau blue blauw bleu	blau blue blauw bleu	
30,5 x 1,5m = 46m ²	16	1,6 mm	R622	R624	R602	R604
30,5 x 1,5m = 46m ²	25	2,5 mm	R922	R924		R904
30,5 x 1,5m = 46m ²	32	3,2 mm	R822	R824	R802	R804
24,38 x 1,5m = 36,57m ²	45	4,5 mm	R522	R524		
18,3 x 1,5m = 27,45m ²	64	6,4 mm	R422		R402	
12,19 x 1,5m = 18,285 m ²	95	9,5 mm	R322		R302	

PPT+ 70056.0.

PLUS

Better wear resistance due to incorporated unwoven **PE-mesh**
Bessere Verschleißfestigkeit durch den integrierten **PE-Schicht**
Hogere slijtvastheid door het ingewerkte **PE-gaas**
Meilleure resistance grâce à la couche **tissue en PE** incorporée

	□	□		
		1	5	
	not perforated	hautfarbe tan huidskleur couleur chair	blau blue blauw bleu	
30,5 x 1,5m = 46m ²	16	1,6 mm	R623	R603
	32	3,2 mm	R823	R803

PPT SR 70057.0.

SLOW RECOVERY

	□	□			
		□	3	700580016	
	not perforated	orange orange orange orange	orange orange orange orange	orange orange orange orange	
30,5 x 1,5m = 46m ²	16	1,6 mm	R642	R644	R643
	32	3,2 mm	R842	R844	

MINIROLLEN
MINI ROLLS
MINI ROLLEN
ROULEAUX MINI



SM/AB
glatt/rauh
smooth/abridged
glad/ruw
lisse/rugueux

AB/AB
beidseitig gerauh
abridged/abridged
beide zijden ruw
les deux côtés rugueux

AB/ME (=PLUS)
rauh/PE-Schicht
abridged/PE-mesh
ruw/PE-gaas
rugueux/tissu en PE

PPT 7006.01.

nicht perforiert
not perforated
niet geperforeerd
non perforé

hautfarbe
tan
huidskleur
couleur chair



	1	2
	SM/AB glatt/rauh smooth/abridged glad/ruw lisse/rugueux	AB/AB beidseitig gerauh abridged/abridged beide zijden ruw les deux côtés rugueux
11,5 x 15m	16 1,6 mm	
11,5 x 15m	32 3,2 mm	
11,5 x 12m	45 4,5 mm	

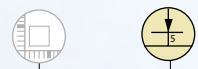

60300002 AFT

Display für Bezugsstoffe auf Mini-Rollen
Display for fabrics on mini rolls
Display voor bekledings-stoffen op mini-rollen
Présentoir pour tissus sur mini rouleaux

PPT® Zwischenschicht
PPT® intermediate layer
PPT® Tussenzool
PPT® intercalaire



PLATTEN
SHEETS
PLATEN
PLAQUES



Exclusive supplier of
the only original PPT
for Europe



→ page 1.40

Laminaten
Laminates
Laminaten
Laminages

PPT 70051.



0
nicht perforiert
not perforated
niet geperforeerd
non perforé

5
perforiert
perforated
geperforeerd
perforé

	1	2	3	4	1	3
	hautfarbe tan huidskleur couleur chair	hautfarbe tan huidskleur couleur chair	blau blue blauw bleu	blau blue blauw bleu	hautfarbe tan huidskleur couleur chair	blau blue blauw bleu
152 x 65cm						
16 1,6 mm	P622	P624	P602	P604	P622-P	P602-P
25 2,5 mm	P922	P924		P904		
32 3,2 mm	P822	P824	P802	P804	P822-P	P802-P
45 4,5 mm	P522	P524			P522-P	
64 6,4 mm	P422		P402			
95 9,5 mm	P322		P302			

PPT+ 70052.0.
PLUS

Bessere Verschleißfestigkeit durch den integrierten PE-Schicht
Better wear resistance due to incorporated unwoven PE-mesh
Hogere slijtvastheid door het ingewerkte PE-gaas
Meillieure resistance grâce à la couche tissu en PE incorporée

	1	2
	hautfarbe tan huidskleur couleur chair	blau blue blauw bleu
152 x 65cm		
16 1,6 mm	P623	P603
32 3,2 mm	P823	P803

PPT SR 70053.0.
SLOW RECOVERY

Bessere Verschleißfestigkeit durch den integrierten PE-Schicht
Better wear resistance due to incorporated unwoven PE-mesh
Hogere slijtvastheid door het ingewerkte PE-gaas
Meillieure resistance grâce à la couche tissu en PE incorporée

	1	2	3
	orange orange orange orange	orange orange orange orange	orange orange orange orange
152 x 65cm			
16 1,6 mm	P642	P644	P643
32 3,2 mm	P842	P844	

Wir liefern Ihnen diese Platten auch gestanzt in jeder Größe.
Custom size may be ordered to best meet special needs.
Deze platen kunnen op gewenste maat geleverd worden.
Nous fournissons ces plaques en mesures souhaitées.

PU DUO LAYER 7023. .530

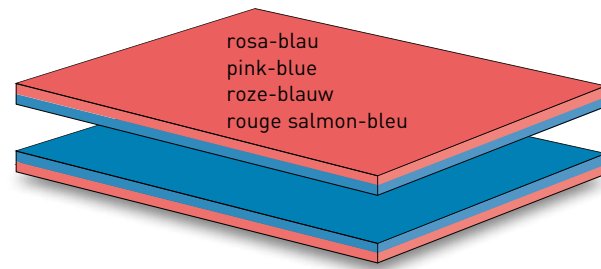

1	Platten sheets platen plaques	5	Rollen rolls rollen rouleaux
□ nicht perforiert/not perforated/ niet geperforeerd/non perforé			
30	3,0 mm	137 x 73 cm = 1m ²	±69 m ²

PU SLOW MICRO 7024. .935

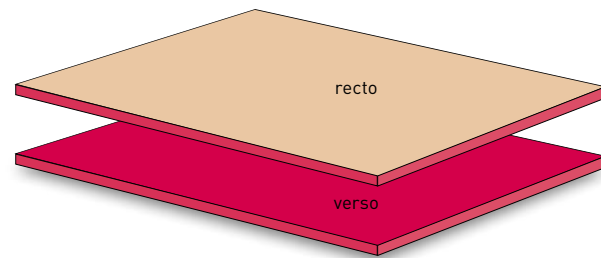

1	Platten sheets platen plaques	5	Rollen rolls rollen rouleaux
□ nicht perforiert/not perforated/ niet geperforeerd/non perforé			
35	3,5 mm	137 x 73 cm = 1m ²	±45 m ²

VI-POD 1528710. 1

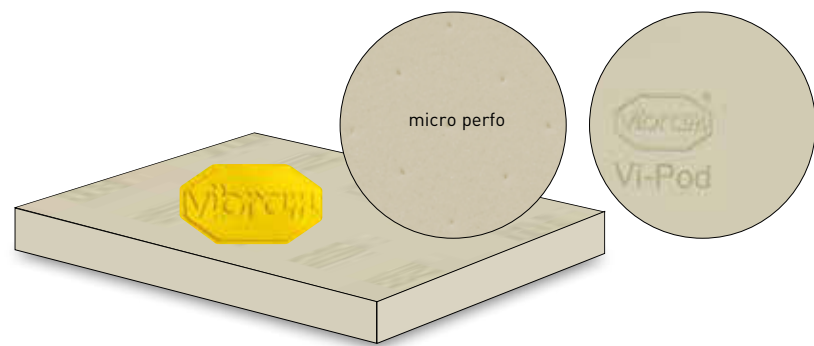

		80 x 50cm	1
		micro perfo	
20	2,0 mm	•	
40	4,0 mm	•	
60	6,0 mm	•	

PORON GEL ANTISHOCK 7025800 1

Eine Kombination von Poron und Gel, sehr gut Shock absorbierend und Komfortable
A combination of Poron and Gel providing an advanced shock absorption and comfort
Combinatie van Poron en gel voor een goede schokabsorptie en comfort
Combinaison de poron sur gel pour obtenir une bonne absorption des chocs ainsi qu'un excellent confort

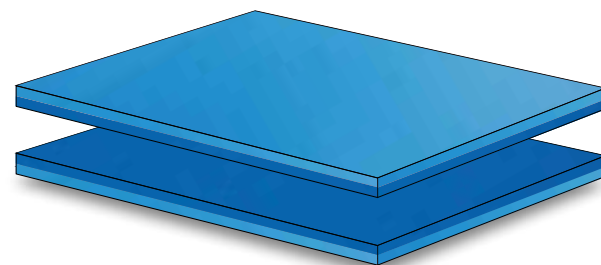

		blau/blue/blauw/bleu
3 mm		•

Farbabweichungen zwischen dem Farbdruk und dem Originalprodukt sind möglich.
Colour differences between print and original product are possible.
Kleurverschillen tussen het drukwerk en het origineel product zijn mogelijk.
Des différences de couleur entre l'imprimerie et la produit originale sont possible.

PU DIABET 7021. .9. 1

rosa/salmonpink/zalmroze/rouge saumon

Die neue Generation langsam wiederherstellender PU Schäume speziell für Diabetiker und Rheumapatienten hat eine viel langsamere Rückstellfähigkeit als PPT. Das Material kommt immer in die Originalform zurück und ist extrem flexibel. Es formt sich perfekt um den Fuß und vermindert Druckstellen.

The new generation of PU foams, for diabetics and people who suffer from rheumatism, have a much slower recovery effect as PPT. Therefore it moulds perfectly the contours of your feet. Walking has never been such a joy. It doesn't fight back and takes away all the pressure points.

De nieuwe generatie PU schuimstoffen speciaal voor diabetici en reumapatiënten hebben een veel langzamer hersteleffect dan PPT. Daardoor vormt het zich perfect rond de voet. Het materiaal verzet zich niet en neemt alle drukpunten weg.

Les nouvelles mousses PU, spécialement pour diabétiques et rhumatisants, ont un effet de récupération beaucoup plus lente que PPT. A cause de ça le matériel se forme parfaitement autour du pied. Il ne résiste pas et enlève tous les points de pression.

PU DIABET SLOW 7022. .9. 1

rot/red/rood/rouge

Die gleichen Eigenschaften wie PU DIABET, hat aber eine noch langsamere Rückstellkraft.

The same properties as PU DIABET, but the recovery is even slower.

Dezelfde eigenschappen als PU DIABET, maar met een nog trager hersteleffect.

Les mêmes caractéristiques que PU DIABET, mais l'effet de récupération est encore plus lent.

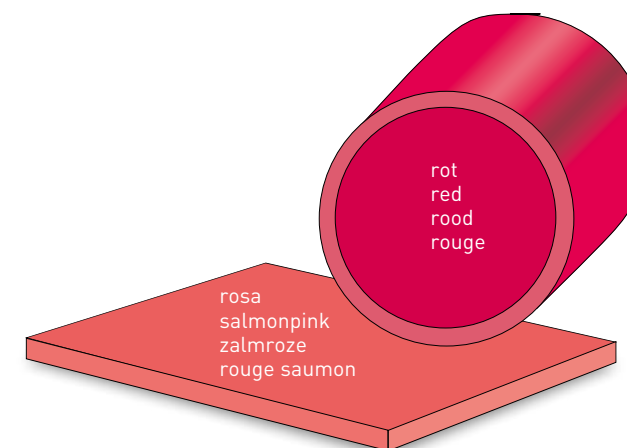

1	Platten sheets platen plaques	5	Rollen rolls rollen rouleaux
□ nicht perforiert not perforated niet geperforeerd non perforé		□ nicht perforiert not perforated niet geperforeerd non perforé	
30	3,0 mm	137 x 73 cm = 1m ²	±59 m ²
45	4,5 mm	137 x 73 cm = 1m ²	±43 m ²
60	6,0 mm	137 x 73 cm = 1m ²	±35 m ²

NOENE 70030. 1

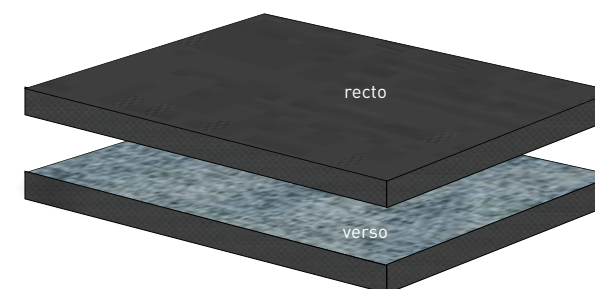

		schwarz/black/zwart/noir
20	2 mm	•
40	4 mm	•

1.09

LAMINATEN
LAMINATES
LAMINATEN
LAMINAGES

TRILAM 7030700.



90 x 100cm

Code	Size	Material	Color	Count
70307001	90 x 100cm	Shore30 - 2mm Shore15 - 2mm Shore35 - 3mm	Blue/Green	1
70307002	90 x 100cm	Shore25 - 2mm Shore15 - 2mm Shore35 - 3mm	Green/Blue	1

Wir verkleben verschiedene Plattenmaterialien für Sie
We can glue different sheet materials together for you
Wij verlijmen voor u verschillende plaatmaterialen tesamen
Possibilité d'assembler plusieurs matériaux

Code	Size	Material	Color	Count
709PB101	50 x 65cm	PPT 1,6mm Extrafoam soft 3mm	Blue	3
709PB102	73 x 65cm	PPT 1,6mm PU Diabet slow 3mm	Red	2
709PU201	67 x 73cm	PU Diabet 3mm PU Diabet slow 3mm	Red	2
709TL201	50 x 75cm	Termolast-20 2mm Plastazote 3mm	Blue	4
709PH103	75 x 65cm	PPT 1,6mm Plastazote 3mm	Red	4
709PU302	68 x 73cm	Suetex 0,5mm PU Diabet 3mm	Red	2
709PH102	50 x 65cm	Suetex 0,5mm PPT 1,6mm	Blue	3

→ part 11
Wir liefern Ihnen diese Platten auch gestanzt in jeder Größe.
We supply all these materials cut in all different sizes.
Deze platen kunnen gestanzt worden in alle mogelijke modellen.
Nous fournissons ces plaques dans chaque modèle découpé.

1.10

BRANDSOHLENMATERIAL
MATERIAL FOR BASE SOLES
MATERIAAL VOOR GROND PATRONEN
MATÉRIAUX POUR PREMIÈRES

DURALUX 72501.

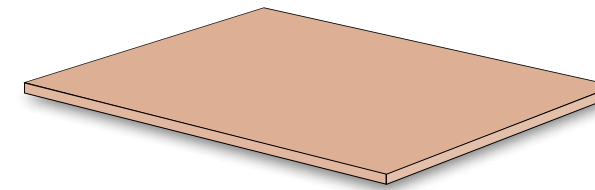

38 x 120cm

Code	Thickness	skin	black
12	1,2 mm	•	•
15	1,5 mm	•	•

DURALITE 725020.

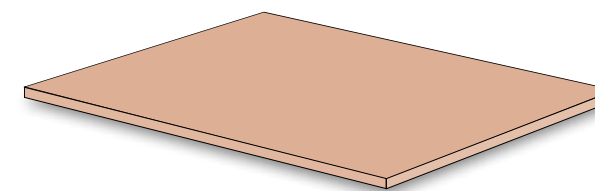

62 x 73cm

Code	Thickness	skin
12	1,2 mm	•

REALUX 725001.

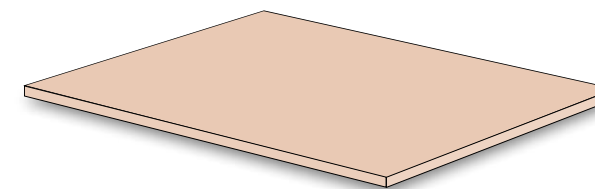

40 x 103cm

Code	Thickness	skin
011	1,1 mm	•
015	1,5 mm	•

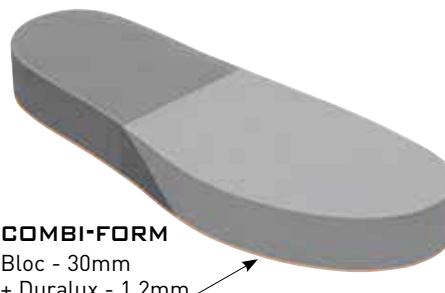

COMBI-FORM
Bloc - 30mm
+ Duralux - 1,2mm

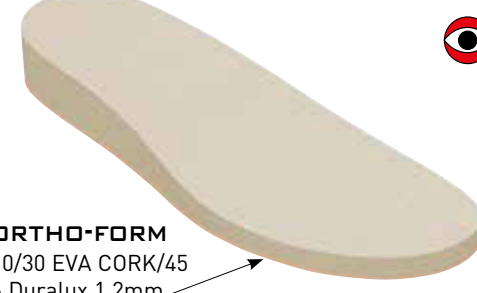

ORTHO-FORM
10/30 EVA CORK/45
+ Duralux 1,2mm

→ part 11
→ part 3.02
Frästechnik
milling techniques
freestechniek
techniques à fraiser

Auch Hardair in 1,5 und 2 mm sind perfekte Brandsohlenmaterialien.
Also Hardair in 1,5 and 2 mm are perfect materials for base soles.
Ook Hardair in 1,5 en 2 mm zijn perfect geschikt als basismateriaal voor grondpatronen.
Aussi Hardair en 1,5 et 2 mm sont des matériaux parfait pour premières.

Farbabweichungen zwischen dem Farbdruck und dem Originalprodukt sind möglich.
Colour differences between print and original product are possible.
Kleurverschillen tussen het drukwerk en het origineel product zijn mogelijk.
Des différences de couleur entre l'imprimerie et la produit originale sont possible.

VACUPRESS FOLIE 72085.

100

Transparente Tiefziehfolie für Vacupress
Transparent thermoplastic sheets for Vacupress
Transparante folie voor Vacupress
Plaques thermoformable transparentes pour Vacupress

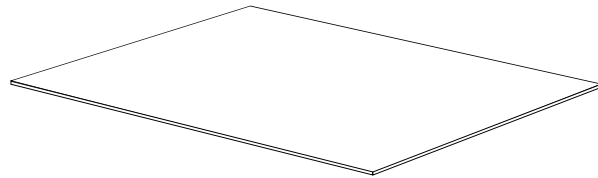

		0,5 mm	
		transparent	
45	450 x 400 mm	•	
60	600 x 450 mm	•	

POLYPROP TRANSPA 72082001

1

120 x 80cm

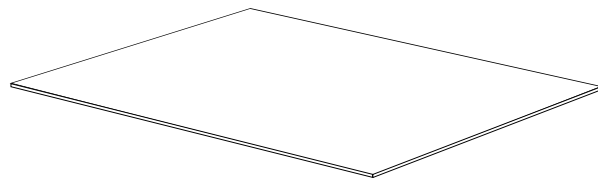

		transparent	
01	0,8 mm	•	

THERMO EVAFOAM 701807804

1

60 x 45cm

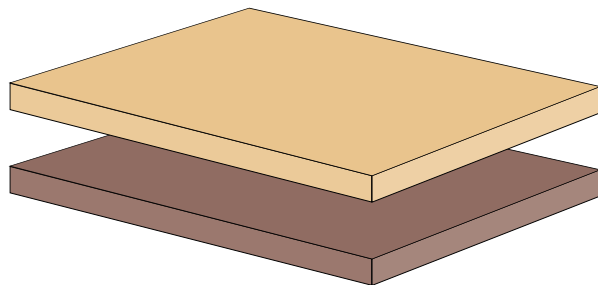

04	4,0 mm	•	



STREIFYLEN 7040.

1

200 x 100cm

Polyethylen, Verformungstemperatur bei 160-170°C, schweißbar, tiefziehfähig, geeignet für Prothesenbau
Polyethylene, high density, thermo mouldable at 160-170°C, suitable for construction of prosthesis
Polyethylen, hoge densiteit, thermisch vervormbaar bij 160-170°C, geschikt voor prothesenbouw
Polyéthylène, haute densité, thermoformage à 160-170°C, pour la construction de prothèses

STREIFYLAST 7043.

1

200 x 100cm

Weich-Polyethylen, Verformungstemperatur bei 130-140°C, tiefziehfähig, geeignet für Prothesenbau
Polyethylene, low density, thermo mouldable at 130-140°C, suitable for construction of prosthesis
Polyethylen, lage densiteit, thermisch vervormbaar bij 130-140°C, geschikt voor prothesenbouw
Polyéthylène, basse densité, thermoformage à 130-140°C, pour la construction de prothèses

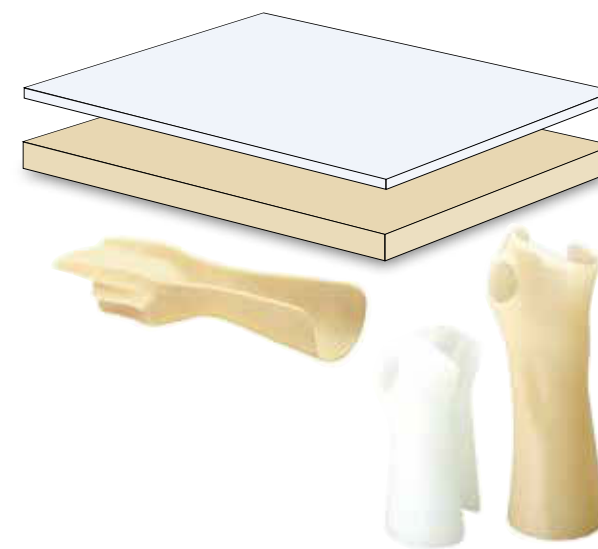

		STREIFYLEN		STREIFYLAST	
		1 skin	6 white	1 skin	6 white
010	1,0 mm	•	•		•
020	2,0 mm		•		•
030	3,0 mm	•	•	•	•
040	4,0 mm	•	•		•
045	4,5 mm			•	
050	5,0 mm	•	•		•
060	6,0 mm		•		

EXTRALENE 7048.

1

100 x 100cm

HDPE, Verformungstemperatur bei 180°C, tiefziehfähig, besonders hohe Festigkeit
HDPE, thermo mouldable at 180°C, extreme high stability
HDPE, thermisch vervormbaar bij 180°C, extreem hoge stabiliteit
HDPE, température de thermoformage 180°C, extrêmement dur

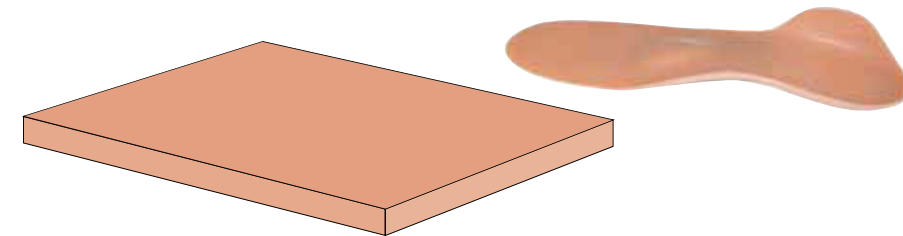

		1 skin	
20	2 mm	•	
30	3 mm	•	
40	4 mm	•	
50	5 mm	•	
60	6 mm	•	

ERKOFLEX 7202.

112 x 88cm

		0	1	5
		transp.		
15	1,5 mm	1m ²	±20 m ²	
30	3,0 mm	1m ²	±20 m ²	

		1		
		0	5	9
		black	blue	red
40	4,0 mm	1m ²	1m ²	1m ²

THERMYTEX 3592.



Thermo regulierend, anti-allergie, atmungsaktiv, feuchtigkeitsaustauschfähig, abwaschbar, Lederprint
 Thermo-regulating, anti-allergy, breathable, absorbent, washable, leather look
 Thermoregulerend, anti-allergie, luchtdoorlatend, vochtabsorberend, afwasbaar, lederlook
 Thermo régulateur, anti-allergie, perméable, absorbant l'humidité, lavable, look cuir

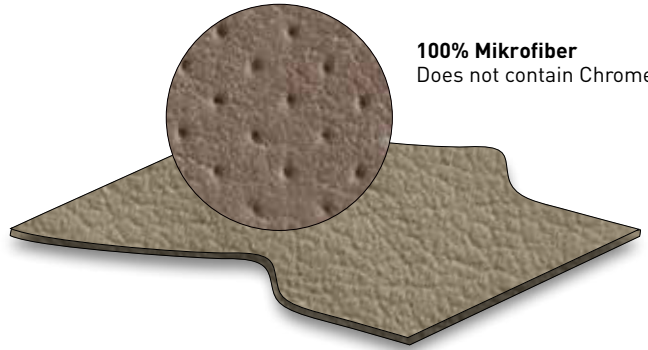

100% Mikrofiber
 Does not contain Chrome 6

**NEU
 NEW
 NIEUW
 NOUVEAU**

	□	5 *
	non perfo	perfo
	in 5 Farben in 5 colours in 5 kleuren en 5 couleurs	in 3 Farben in 3 colours in 3 kleuren en 3 couleurs
□	100 x 137cm - 0,8mm	• •
1	11,5cm x 25m - 0,8mm	• •
2	140cm x 50m - 0,8mm	• •

01	30	05	90	64	12 *	07 *	03 *
schwarz black zwart noir	platin platinum platina platine	hell beige light beige lichtbeige beige clair	champagne	kamel camel kameel chameau	kaffee coffee koffie café	dunkelgrau dark grey donker grijs gris foncé	taupe

THERMY-POINT 3591.



Thermo regulierend, anti-allergie, atmungsaktiv, feuchtigkeitsaustauschfähig, abwaschbar, Lederprint
 Thermo-regulating, anti-allergy, breathable, absorbent, washable, leather look
 Thermoregulerend, anti-allergie, luchtdoorlatend, vochtabsorberend, afwasbaar, lederlook
 Thermo régulateur, anti-allergie, perméable, absorbant l'humidité, lavable, look cuir



100% Mikrofiber
 Does not contain Chrome 6

**NEU
 NEW
 NIEUW
 NOUVEAU**

	□	non perfo
	1	4
	schwarz black zwart noir	beige beige beige beige
□	100 x 137cm - 0,8mm	• •
1	11,5cm x 25m - 0,8mm	• •
2	140cm x 50m - 0,8mm	• •

SUETEX 3593.

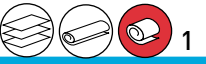

Abwaschbar, reißfest, hohe Zugkraft, atmungsaktiv, lichtbeständig, abriebfest, farbecht und wasserdampfdurchlässig
 Washable, strong, high tractive power, air transmittable, vapour transmittable, colourfast, friction fast
 Afwasbaar, schuift niet, hoge trekkracht, luchtdoorlatend, vochtdoorlatend, kleurecht, wrijfbestendig
 Lavable, résistant, haute force de traction, perméable de l'air et de l'humidité, anti-friction, fixe couleur

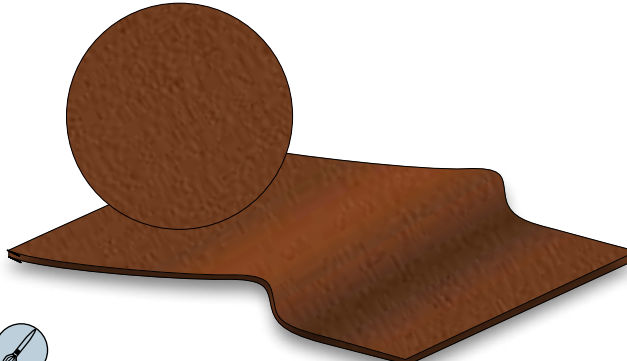

	□	100 x 137cm - 0,7mm	•
1	11cm x 25m - 0,7mm	•	
2	137cm x 50m - 0,7mm	•	

in 6 Farben
all 6 colours
alle 6 kleuren
toutes les 6 couleurs

00	17	01	03	05	11
schwarz black zwart noir	grau grey grijs gris	dunkelbraun dark brown donkerbruin brun foncé	hell beige light beige lichtbeige beige clair	dunkelblau dark blue donkerblauw bleu foncé	mittelbraun middle brown middelbruin brun moyen

CAMBRELL 3597.



Sehr dünne Bezugsstoffe für Einlagen
 Very thin covering tissue for inlays
 Zeer dun afdek materiaal voor steunzolen
 Tissu de recouvrement très mince pour des semelles orthopédiques



	□	100 x 150cm - 0,5mm.	•	•
1	11,5cm x 50m - 0,5mm.	•		
2	150cm x 50m - 0,5mm.	•		

00	schwarz black zwart noir	09	rot red rood rouge
-----------	-----------------------------------	-----------	-----------------------------

VILEDON 3595.

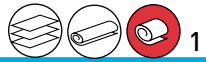

Sehr dünne Bezugsstoffe für die Unterseite von Einlagen
 Very thin covering tissue for the underside of inlays
 Zeer dun afdek materiaal voor onderkant steunzolen
 Tissu de recouvrement très mince pour le dessous des semelles orthopédiques

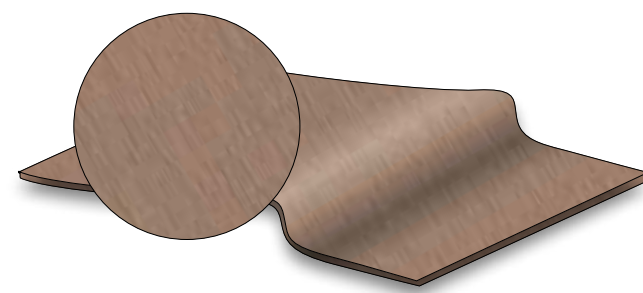

	□	100 x 150cm - 0,5mm	•
1	12,5cm x ±50m - 0,5mm	•	
2	150cm x ±50m - 0,5mm	•	

00	beige beige beige beige
-----------	----------------------------------

Farbabweichungen zwischen dem Farbdruck und dem Originalprodukt sind möglich.
 Colour differences between print and original product are possible.
 Kleurverschillen tussen het drukwerk en het origineel product zijn mogelijk.
 Des différences de couleur entre l'imprimerie et la produit originale sont possible.

SKAILINA 3594.

Lederimitation ohne Profil, atmet, abwaschbar, hautfreundlich, sehr dünn und preisgünstig.
Imitation leather without profile, breathes, washable, skin friendly, very thin and price worthy.
Imitatieleder zonder profiel, ademt, afwasbaar, huidvriendelijk, zeer dun en gunstig van prijs.
Imitation-cuir sans profile, lavable, respire, peau agréable, très fin et favorable.

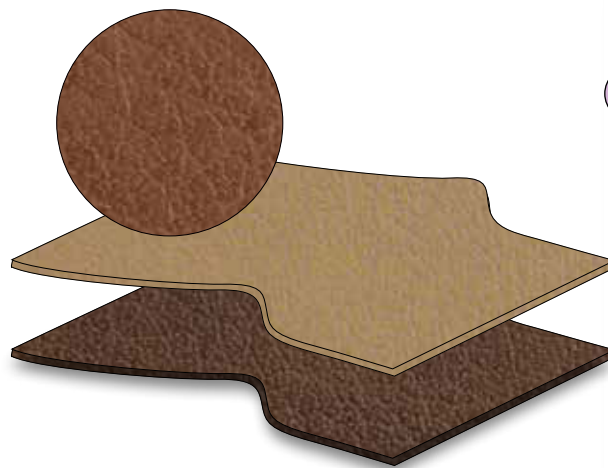

			00	03	
			in 9 Farben all 9 colours alle 9 kleuren les 9 couleurs	schwarz black zwart noir	elfenbein ivory ivoor ivoir
□	100 x 145 cm		•		
1	11 cm x 50 m		•		
2	145 cm x 50 m		•		
3	100 x 145 cm PERFO-SP		•	•	
4	11 cm x 50 m PERFO-SP		•	•	
5	145 cm x 50 m PERFO-SP		•	•	

00	01	03	04	08	11	S1	S3	S4
schwarz black zwart noir	dunkelbraun dark brown donkerbruin brun foncé	elfenbein ivory ivoor	beige	grau grey grijs gris	natur natural naturel	braun brown bruin brun	amber amber ambre	creme creme creme crème

LETEX 3590.

Baumwollgewebe-Bezugsstoff: abwaschbar, atmungsaktiv, reißfest, lichtecht, feuchtigkeitsaustauschfähig, kein Abfärben
Cotton covering tissue: washable, air transmittable, strong, colourfast, absorbent
Katoen geweven bekledingsstof: afwasbaar, luchtdoorlatend, schuift niet, kleurvast, vochtabsorberend
Tissu de recouvrement en coton: lavable, perméable, résistant, fixe couleur, absorbant humidité

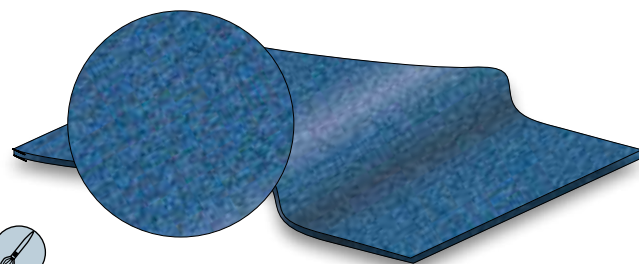

			in 4 Farben in 4 colours in 4 kleuren en 4 couleurs
□	100 x 145cm - 1 mm		•
1	11cm x 30m - 1 mm		•
2	145cm x 30m - 1 mm		•

00	17	11	08
schwarz black zwart noir	grau grey grijs gris	braun brown bruin brun	königsblau royal blue koningsblauw bleu royal

60300002 AFT

Display für Bezugsstoffe auf Mini-Rollen
Display for fabrics on mini rolls
Display voor bekledings-stoffen op mini-rollen
Présentoir pour tissus sur mini rouleaux

PPT, EVA MARBLE, THERMYTEX, THERMY-POINT, SUETEX,
CAMBRELL, VILEDON, SKAILINA, LETEX



MINI-ROLLEN

Schneller arbeiten und
weniger Verlust!

Work faster and
less loss of material!

sneller werken en minder
materiaalverlies

Travaillez plus vite et moins
de perte de matériel

STELLEN SIE IHRE EIGENE
KOMBINATION ZUSAMMEN!

MAKE YOUR OWN
COMBINATION!

STEL UW EIGEN
COMBINATIE SAMEN!

ASSEMBLEZ VOTRE
PROPRE COMBINAISON!

Das Mini-Rollen Display
erlaubt eine endlose
Flexibilität. Wählen Sie 6
Rollen mit verschiedenen
Stoffen, z.B.

The Mini-Roll system
offers you a lot of
flexibility.
Choose 6 rolls of the
above materials.

Met het Mini-Rol systeem
geniet u van een eindeloze
flexibiliteit.
Kies zelf 6 rollen uit boven-
staande materialen.

En employant ce système
vous bénéficiez d'une flexi-
bilité super.
Choisissez 6 rouleaux
des matériaux ci-dessus.

SMILEY COVER 3596000

NEU
NEW
NIEUW
NOUVEAU

100 x 148cm



Farbabweichungen zwischen dem Farbdruck und dem Originalprodukt sind möglich.
Colour differences between print and original product are possible.
Kleurverschillen tussen het drukwerk en het origineel product zijn mogelijk.
Des différences de couleur entre l'imprimerie et la produit originale sont possible.

ORTHOPRENE 3598.



210 x 135cm

EINSEITIG
ONE-SIDED
ENKELZIJDIG
UNE FAÇE

Einseitig textilbeschichtet, viele Farben möglich; Kletttaftung möglich.
Bei Bestellungen immer Farbnummer mit angeben!

One side covered with fabric, many colours available; velcro possible.
Please mention colour number when you place your order!

Eenzijdig met stof bekleed, grote kleurkeuze; klittenband mogelijk.
Bij bestelling steeds het kleurnummer vermelden!

Une face couverte de tissu dans un grand choix de couleurs; possibilité de velcro.
Veillez indiquer le numéro de la couleur quand vous passez votre commande.

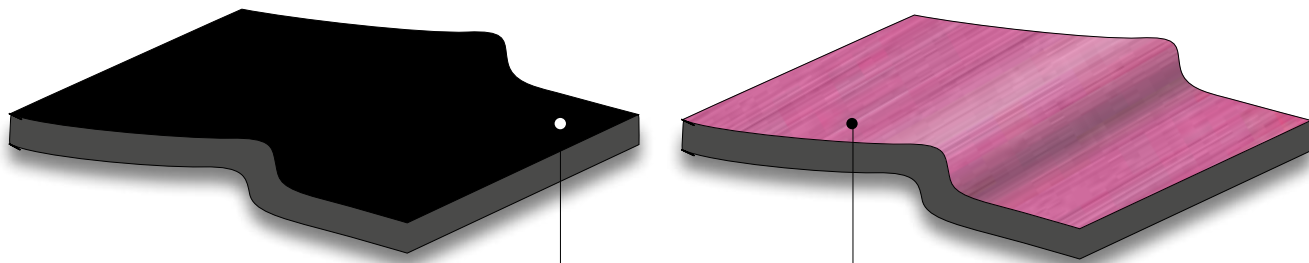

ORTHOPRENE
=NEOPRENE



00

eine Seite Orthoprene
one side Orthoprene
ene zijde Orthoprene
une façade Orthoprene

Bezugsstoff 0,5mm. in 19 Farben
fabric 0,5mm. all 19 colours
bekledingsstof 0,5mm. alle 19 kleuren
tissu 0,5mm. les 19 couleurs

02	2,0 mm	•	•
03	3,0 mm	•	•
04	4,0 mm	•	•
05	5,0 mm	•	•
06	6,0 mm	•	•
07	7,0 mm	•	•

Farbabweichungen zwischen dem Farbdruck und dem Originalprodukt sind möglich.
Colour differences between print and original product are possible.
Kleurverschillen tussen het drukwerk en het origineel produkt zijn mogelijk.
Des différences de couleur entre l'imprimerie et la produit originale sont possible.

ORTHOPRENE 3598.



210 x 135cm

DOPPELSEITIG
DOUBLE SIDED
TWEEZIJDIG
DOUBLE FAÇE

Beidseitig textilbeschichtet, viele Farbkombinationen möglich; Kletttaftung möglich.
Bei Bestellungen immer zwei Farbnummern mit angeben!

Both sides covered with fabric, colour combinations with various colours; velcro possible.
Please mention both colour numbers when you place your order!

Beide zijden met stof bekleed, vele kleurcombinaties mogelijk; klittenband mogelijk.
Bij bestelling steeds de beide kleurnummers opgeven!

Deux faces couvertes de tissu dans un grand choix de couleurs; possibilité de velcro.
Veillez indiquer les deux numéros de couleurs quand vous passez votre commande.

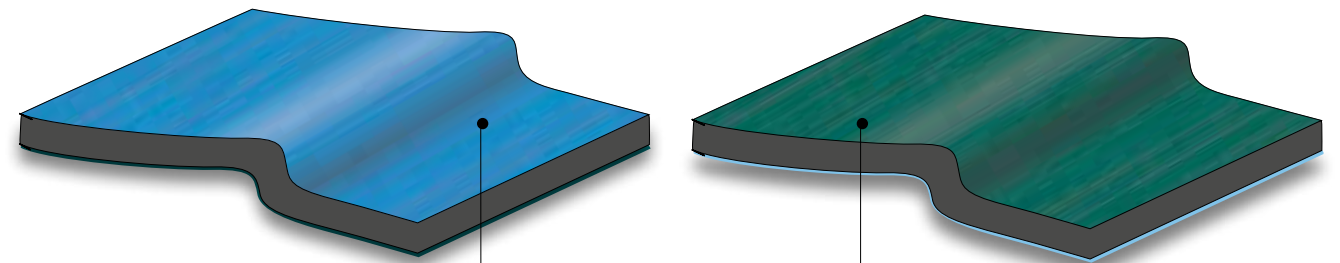

ORTHOPRENE
=NEOPRENE



Bezugsstoff 0,5mm. in 19 Farben
fabric 0,5mm. all 19 colours
bekledingsstof 0,5mm. alle 19 kleuren
tissu 0,5mm. les 19 couleurs

Bezugsstoff 0,5mm. in 19 Farben
fabric 0,5mm. all 19 colours
bekledingsstof 0,5mm. alle 19 kleuren
tissu 0,5mm. les 19 couleurs

02	2,0 mm	•	•
03	3,0 mm	•	•
04	4,0 mm	•	•
05	5,0 mm	•	•
06	6,0 mm	•	•
07	7,0 mm	•	•

Farbabweichungen zwischen dem Farbdruck und dem Originalprodukt sind möglich.
Colour differences between print and original product are possible.
Kleurverschillen tussen het drukwerk en het origineel produkt zijn mogelijk.
Des différences de couleur entre l'imprimerie et la produit originale sont possible.

ORTHOPRENE
=NEOPRENE

30	29	28	25	27	20	22	23	19
schwarz black zwart noir	dunkel Grau dark grey donkergrijs gris foncé	grau grey grijs gris	wollweiss eggshell gebroken wit blanc cassé	weiss white wit blanc	türkis turquoise turquoise	marine Blau navy blue marine blauw bleu marine	nacht Blau night blue nacht blauw bleu nuit	violett violet violet violet

26	16	14	12	08	07	01	02	05	04
braun brown bruin brun	rotbraun reddish brown roodbruin rouge brun	kirschrot cherry red kersrood rouge cerise	rot red rood rouge	neon Orange neon orange neon oranje orange néon	gelb yellow geel jaune	neon Gelb neon yellow neon geel jaune néon	neon Grün neon green neon groen vert néon	olive Grün olive green olijfgroen vert olive	moos Grün moss-green mosgroen vert mousse

RUBBER 742000

Elastischer gummi Rahmen
Elastic rubber welt
Elastische rubber rand
Trépointe élastique

schwarz
black
zwart
noir



NEU
NEW
NIEUW
NOUVEAU



76 x 3,4cm - 2mm

Bestellung pro 2 Paare (= 4 Längen)
Order per 2 pairs (= 4 lengths)
Afname per 2 paar (= 4 lengtes)
Commande par 2 paires (= 4 longueurs)

ZEPHIR RUBBER 7417120.

micro-cell gummi Rahmen
micro cell rubber welt
microcel rubber rand
Trépointe micro-cell-caoutchouc

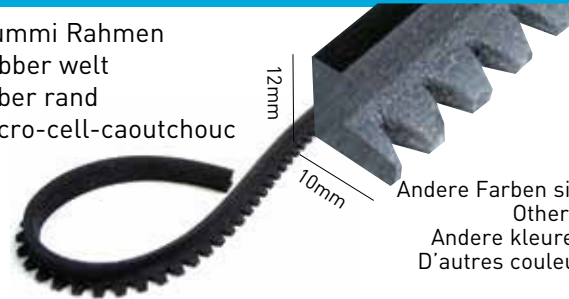

Andere Farben sind lieferbar ab einer Bestellmenge von min. 25m.
Other colours are available per minimum order of 25m.
Andere kleuren verkrijgbaar op bestelling vanaf minimum 25m.
D'autres couleurs sont livrables sur commande, à partir de 25m.

NEU
NEW
NIEUW
NOUVEAU

0	1	6	7
black	d.brown	white	caramel

PORO 7414.

Runde Krempe
round border
ronde board
bord ronde



7415.

Breite Krempe
large border
brede board
bord large



HARDAIR

in 16 Farben
all 16 colours
alle 16 kleuren
toutes les 16 couleurs

Andere Formen sind lieferbar ab einer Bestellmenge von min. 100m.

Other models are available per minimum order of 100m.

Andere modellen verkrijgbaar op bestelling vanaf minimum 100m.

D'autres modèles sont livrables sur commande, à partir de 100m par référence.

PORO HARDAIR

109	111	166	197	181	105	189	187
weiß white wit blanc	hellgrau light grey lichtgrijs gris clair	mittelgrau medium grey middelgrijs gris moyen	dunkelgrau dark grey donkergrijs gris foncé	schwarz black zwart noir	hellbeige light beige lichtbeige beige clair	arena	tierra
135	185	122	198	146	106	178	159
beige	taupe antelope leverbeige gabardine	hellbraun light brown lichtbruin brun clair	otter	dunkelbraun dark brown donkerbruin brun foncé	rot red rood rouge	dunkelblau dark blue donkerblauw bleu foncé	dunkelgrün dark green donkergroen vert foncé

Farbabweichungen zwischen dem Farbdruck und dem Originalprodukt sind möglich.
Colour differences between print and original product are possible.
Kleurverschillen tussen het drukwerk en het origineel product zijn mogelijk.
Des différences de couleur entre l'imprimerie et la produit originale sont possible.

7412.

GUMMI - RUBBER - RUBBER - CAOUTCHOUC

gezahnt
toothed
getand
dentelé

	10	0	1
	20	0	1
	21	0	1
	24	0	1
	25	0	1
	26	0	1
	27	0	1
	28	0	1
	29	0	1
	30	0	1
	35	0	1
	36	0	1



















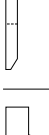
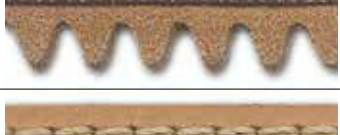
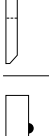
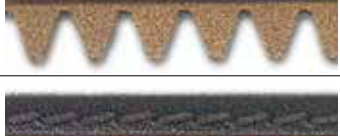

1m

	37	0	1	4
	38	0	1	4
	39	0	1	4
	40	0	1	4
	41	0	1	4
	42	0	1	4
	43	0	1	4
	44	0	1	4
	45	0	1	4
	50	0	1	4
	60	0	1	4
	61	0	1	4

7410.  

 1m



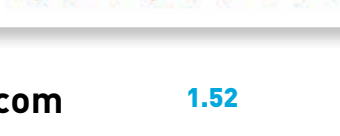









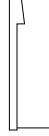

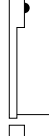

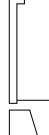

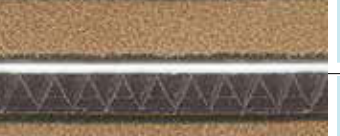

LEDER - LEATHER - LEADER - CUIR



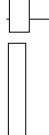

gezahnt toothed getand dentelé				
		 □	1	4
		black	brown	natural
		02	•	•
		04	•	•
		11	•	•
		12	•	•
		21	•	•
		22	•	•
		23	•	•
		25	•	•
		30	•	•
		35	•	•
		40		•

7411.  

 1m

LEDER - LEATHER - LEADER - CUIR

glatt smooth vlak lisse				
		 □	1	4
		black	brown	natural
		02	•	•
		21	•	•
		23	•	•
		24	•	•
		29	•	•
		30	•	•
		35	•	•
		37	•	•
		38	•	•
		59	•	•
		65	•	•

		 □	1	4
		black	brown	natural
	50	6 mm 7 mm	6 mm 7 mm	6 mm 7 mm 16 mm 18 mm
				

Farbabweichungen zwischen dem Farbdruck und dem Originalprodukt sind möglich.
Colour differences between print and original product are possible.
Kleurverschillen tussen het drukwerk en het origineel produkt zijn mogelijk.
Des différences de couleur entre l'imprimerie et la produit originale sont possible.



**ABSÄTZE, SOHLEN, STREIFEN
HEELS, SOLES, STRIPES
HAKKEN, ZOLEN, STROKEN
TALONS, SEMELLES, BANDES DÉCOUPÉES**



AFT®
AFT-International.com

2.01	STIFTFLECKE DOWEL LIFTS STIFTHAKKEN BONBOUTS À TIGE	2.2
2.02	ABSÄTZE HEELS HAKKEN TALON	2.4
2.03	STREIFEN STRIPES STROKEN BANDES DÉCOUPÉS	2.9
2.04	KEILSTREIFEN RUBBER STRIPES SCHUINE STROKEN BANDES BISEAUTÉES	2.13
2.05	SOHLEN SOLES ZOLEN SEMELLES	2.14
2.06	VIBRAM PLATTEN VIBRAM SHEETS VIBRAM PLATEN VIBRAM PLAQUES	2.18
2.07	VIBRAM 1/1 PROFILLANGSOHLEN VIBRAM 1/1 PROFILE LONG SOLES VIBRAM 1/1 PROFIELZOLEN VIBRAM 1/1 SEMELLES PROFILÉES	2.21
2.08	VIBRAM 1/2 PROFILSOHLEN VIBRAM 1/2 PROFILE SOLES VIBRAM 1/2 PROFIELZOLEN VIBRAM 1/2 SEMELLES PROFILÉES	2.27
2.09	VIBRAM FORMABSÄTZE VIBRAM MOULDED HEELS VIBRAM GEVORMDE HAKKEN VIBRAM TALONS MOULÉS	2.29
2.10	PROFILLANGSOHLEN PROFILE LONG SOLES PROFIELZOLEN SEMELLES PROFILÉES	2.31

SUPERTAP 1202.

50p.

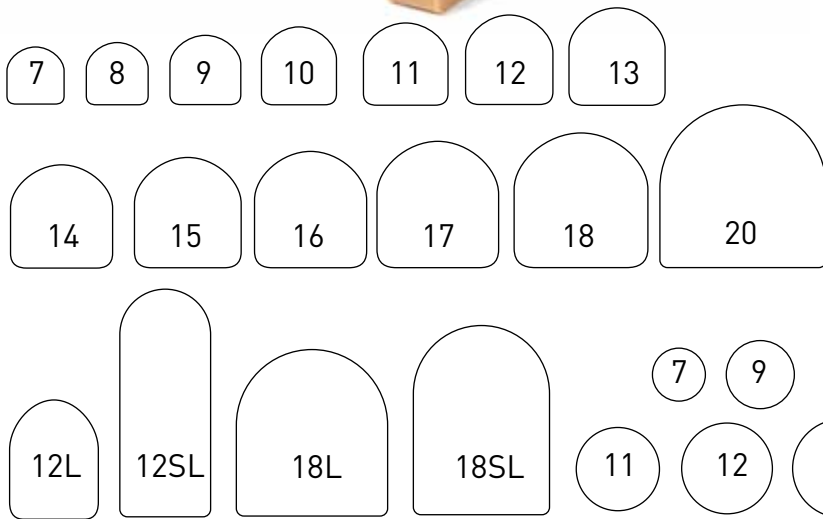

18x34 mm
1202234
 schwarz/black/zwart/noir
1202634
 beige
 10 p.

27x24 mm
1202227
 schwarz/black/zwart/noir
1202627
 beige

	0	4
	schwarz black zwart noir	beige beige beige beige
07	●	
08	●	
09-18	●	●
20	●	●
12L	1202112L	
12SL	1202212SL	
18L	1202118L	1202518L
18SL	1202218SL	1202618SL

	8
	weiß white wit blanc
09	●
11	●
13	●
15	●

	3 THIN-PIN	7 THIN-PIN
	schwarz black zwart noir	beige beige beige beige
10	●	●
14	●	●

	RO
	schwarz black zwart noir
07	●
09	●
11	●
12	●
13	●



Dose/box/doos/boîte, 235 p.
 Art. Nr. 1202000

1. stiftflecke messing
 dowel lifts messing
 stifthakken messing
 bonbouts à tige messing

12p.

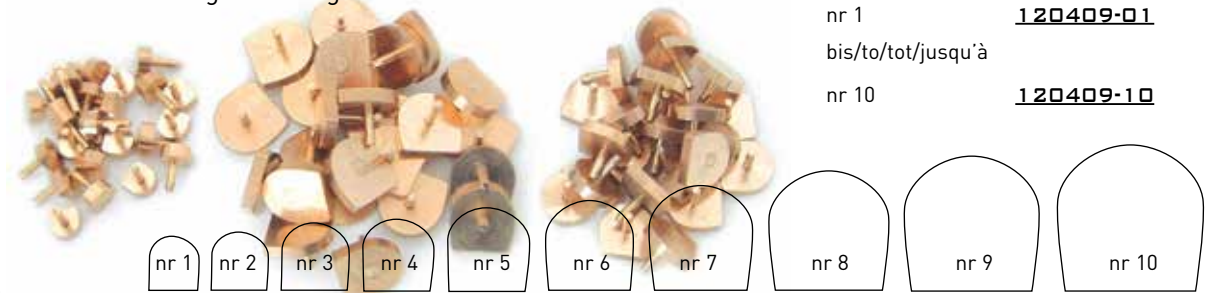

nr 1 **120409-01**
 bis/to/tot/jusqu'à
 nr 10 **120409-10**

2. Schwermetallhülsen EXTRA
 Heavy metal dowels
 Stalen buisjes
 Goupilles métalliques

Ø 2,8 x 50 mm - 100 ex.
4410

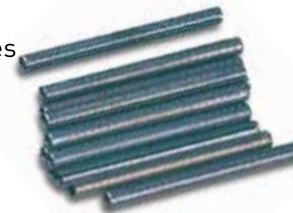

6. Holzdübel EXTRA
 Wooden dowels
 Ronde houten stokjes
 Baguettes rondes en bois

0,5kg

L = 40 mm - 0,5kg
 Ø3mm **83630**
 Ø4mm **83640**
 Ø5mm **83650**
 Ø6mm **83660**



3. Metall-spannhülsen EXTRA
 Flexible metal tubes
 Metalen spanhuls
 Chevilles en métal souple

Ø 2,8 mm - 100 ex.
4420



4. Hüsendurchschläger EXTRA
 Dowel punching tool
 Doorslag met huls
 Chasse-goupilles

Ø 2,8 mm
6076004000



7. Holznägel EXTRA
 Wooden pins
 Houten pinnen
 Chevilles en bois

0,5kg

5 x 8 mm **8305**
 7 x 9 mm **8307**
 8 x 8 mm **8308**
 5 x 30 mm **8330**
 5/5 x 34 mm **8334**
 4 x 42 mm **8342**



5. Bohrer für Damenabsätze
 Drill for ladies' heels
 Boortjes voor dameshakken
 Mèche pour talons dames

Rechts/right/rechts/droite 2,8 mm 10p. **8001**
 Links/left/links/gauche 2,8 mm 1p. **8002**



TRADITION 121.  40



	6		7		
	6 mm		7 mm		
	0	1	0	1	4
	schwarz black zwart noir	braun brown bruin brun	schwarz black zwart noir	braun brown bruin brun	beige beige beige beige
01	•	•	•	•	•
02	•	•	•	•	•
03	•	•	•	•	•
04	•	•	•	•	•
05			•	•	•

MONTE ROSA 1237.  20
7 mm

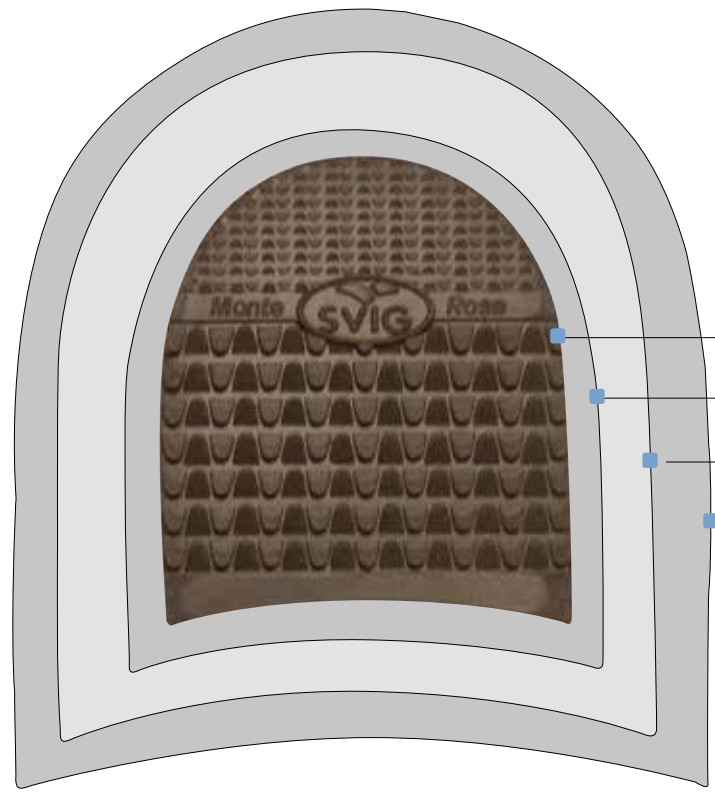

	0	1	7
	schwarz black zwart noir	braun brown bruin brun	karamell toffee karamel caramel
00	•	•	
01	•	•	•
02	•	•	•
04	•	•	•



CROWN 1001. 



	2		3	
	per KG by kg per kg par kg		per 50 Paar by 50 pair per 50 paar par 50 pairs	
	505 (=5L) → 513 (=13L) 14 → 25 24D → 50D			
	0	1	4	
	schwarz black zwart noir	braun brown bruin brun	beige beige beige beige	
6	6,0 mm	•	•	•
8	8,0 mm		•	
9	10,0 mm		•	

→ part 11.01

DUO-TOP 1004. 

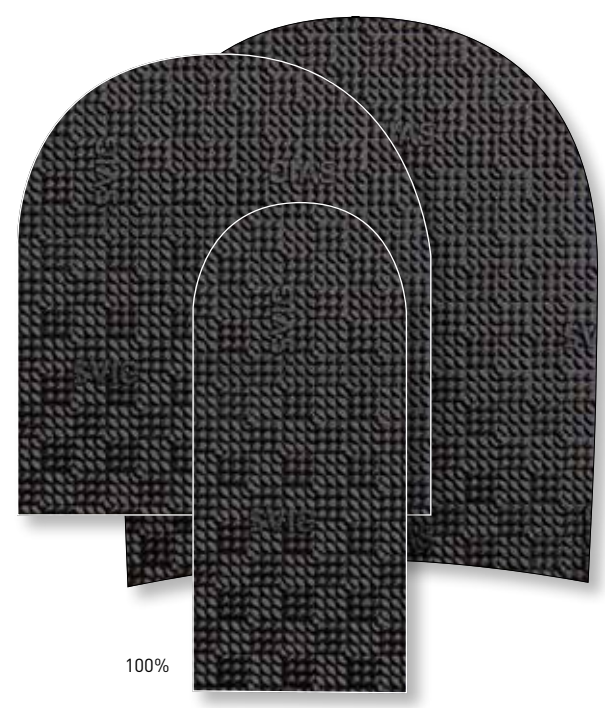

	2		3	
	per KG by kg per kg par kg		per 50 Paar by 50 pair per 50 paar par 50 pairs	
	505 (=5L) → 513 (=13L) 14 → 25 24D → 50D			
	0	1	7	
	schwarz black zwart noir	braun brown bruin brun	karamell toffee karamel caramel	
6	6,0 mm	•	•	•

→ part 11.01

ITALY 12406.

6 mm

NEU
NEW
NIEUW
NOUVEAU

10

100%



			schwarz/beige black/beige zwart/beige noir/beige
03	3		•
04	4		•

VKL 115.

- kg

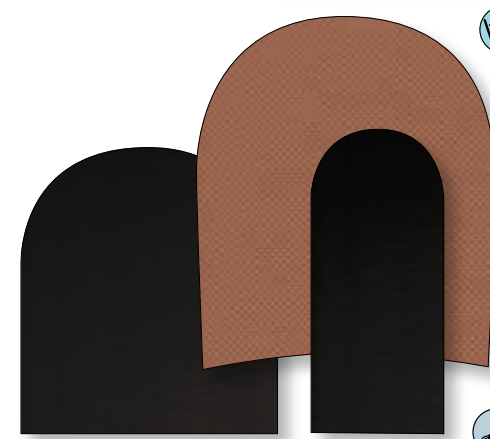

0		1		5	
VKL	4,5 mm	VKL	4,5 mm	VKL	4,5 mm
glatt		glatt		Diamant	
smooth		smooth		diamant	
glad		glad		diamant	
lisse		lisse		diamant	
+		+		+	
Gummi	1,2 mm	Leder	1,2 mm	Gummi	1,2 mm
rubber		leather		rubber	
rubber		leder		rubber	
caoutchouc		cuir		caoutchouc	

0	1	0	1	0	1	4
schwarz	braun	schwarz	braun	schwarz	braun	beige
black	brown	black	brown	black	brown	beige
zwart	bruin	zwart	bruin	zwart	bruin	beige
noir	brun	noir	brun	noir	brun	beige

→ part 11.01

505 > 513	•	•	•	•	•	•
008 > 025	•	•	•	•	•	•
024D > 050D	•	•	•	•	•	•

MEZZO 12408.

8 mm

NEU
NEW
NIEUW
NOUVEAU

10

100%



			schwarz/beige black/beige zwart/beige noir/beige
03	3		•
04	4		•

GUM-TOP 1009.

100%



2	3
per KG	per 50 Paar
by kg	by 50 pair
per kg	per 50 paar
par kg	par 50 pairs

6
6,0 mm

0	1
schwarz	braun
black	brown
zwart	bruin
noir	brun

→ part 11.01

505 > 513	•	•
14 > 25	•	•
24D > 50D	•	•

2.02 ABSÄTZE
HEELS
HAKKEN
TALON

CREPINA SOFT 1005.

Shore A60

CREPINA HARD 1006.

Shore A95

100%



2 per KG by kg per kg	3 per 50 Paar by 50 pair per 50 paar par 50 pairs
6 6,0 mm	
in 16 Farben all 16 colours alle 16 kleuren toutes les 16 couleurs	

505 > 513	●
14 > 25	●
24D > 50D	●

→ part 11.01

CREPINA SOFT, CREPINA HARD

109	111	166	197	181	105	189	187
weiß white wit blanc	hellgrau light grey lichtgrijs gris clair	mittelgrau medium grey middelgrijs gris moyen	dunkelgrau dark grey donkergrijs gris foncé	schwarz black zwart noir	hellbeige light beige lichtbeige beige clair	arena	tierra
135	185	122	198	146	106	178	159
beige	taupe antelope leverbruin gabardine	hellbraun light brown lichtbruin brun clair	otter	dunkelbraun dark brown donkerbruin brun foncé	rot red rood rouge	dunkelblau dark blue donkerblauw bleu foncé	dunkelgrün dark green donkergroen vert foncé

2.03 STREIFEN
STRIPES
STROKEN
BANDES DÉCOUPÉS

CREPINA SOFT 1356.

10

CREPINA HARD 1357.

10

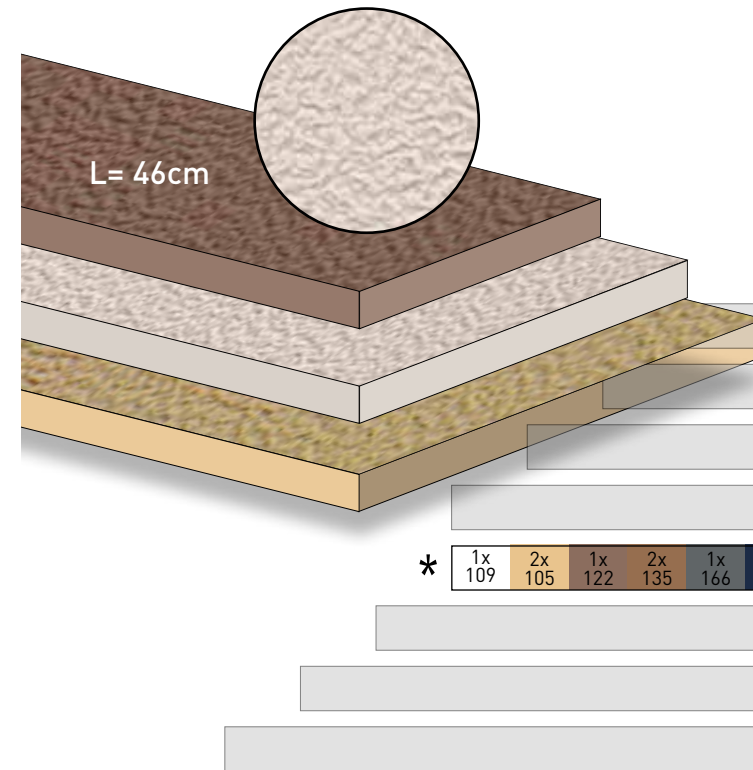

6 6 mm	in 16 Farben all 16 colours alle 16 kleuren toutes les 16 couleurs	
30	30 mm	●
40	40 mm	●
50	50 mm	●
60	60 mm	●
70	70 mm	●
70	70 mm	*
80	80 mm	●
90	90 mm	●
99	100 mm	●



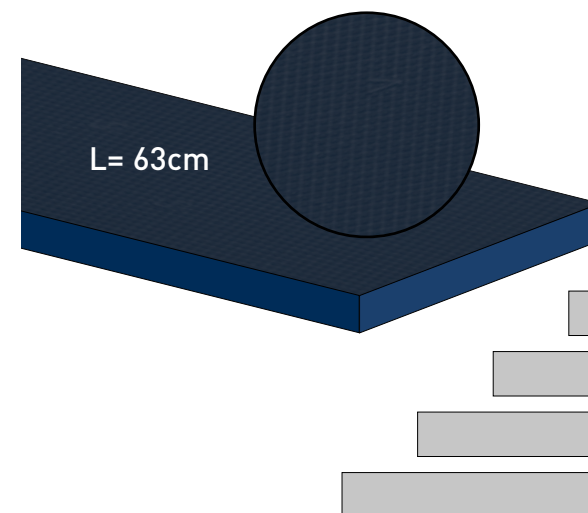

* farblich sortiert / colour assorted / kleurassortiment / assort. de couleurs:
SOFT: 1356670AS
HARD: 1357670AS

DIAMANTINO FINE 135365.

10



6 6 mm		
5 blau blue blauw bleu		
60	60 mm	●
70	70 mm	●
80	80 mm	●
85	85 mm	●
90	90 mm	●

CROWN 1354.     10

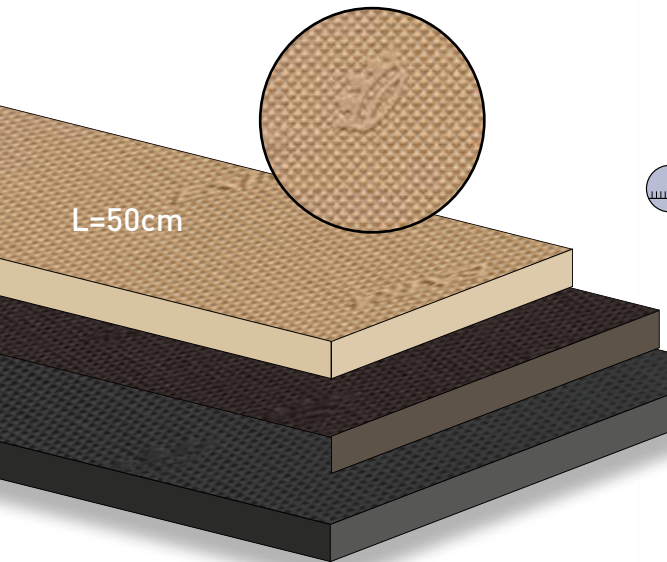

		6		8		9	
		6 mm		8 mm		10 mm	
						 5	
		0	1	4	1	1	
		schwarz black zwart noir	braun brown bruin brun	beige beige beige beige	braun brown bruin brun	braun brown bruin brun	
30	30 mm	•	•	•	•	•	
40	40 mm	•	•	•	•	•	
50	50 mm	•	•	•	•	•	
60	60 mm	•	•	•	•	•	
70	70 mm	•	•	•	•	•	
80	80 mm	•	•	•	•	•	
90	90 mm	•	•	•	•	•	
99	100 mm	•	•	•	•	•	

MEXICO DIAMANTINO 13536.    10

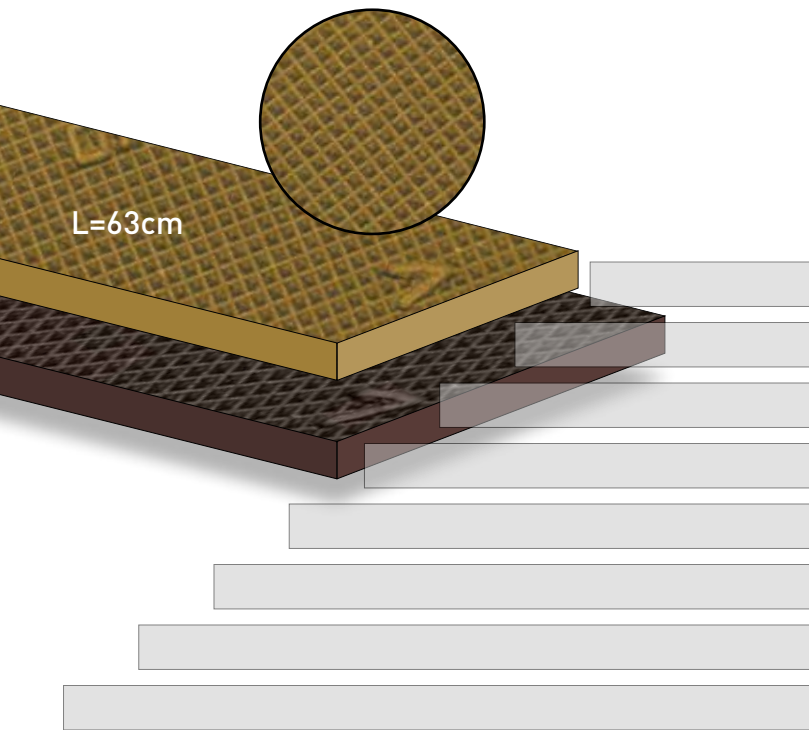

		6		
		6 mm		
		0	1	7
		schwarz black zwart noir	braun brown bruin brun	karamell toffee karamel caramel
30	30 mm	•	•	•
40	40 mm	•	•	•
50	50 mm	•	•	•
60	60 mm	•	•	•
70	70 mm	•	•	•
80	80 mm	•	•	•
90	90 mm	•	•	•
99	100 mm	•	•	•

VKL 136.     10

		0		1		5		
		VKL +	4,5mm	VKL +	4,5mm	VKL-D +	4,5mm	
		Gummi rubber rubber caoutchouc	1,2mm	Leder leather leather cuir	1,2mm	Gummi rubber rubber caoutchouc	1,2mm	
		0	1	0	1	0	1	4
		schwarz black zwart noir	braun brown bruin brun	schwarz black zwart noir	braun brown bruin brun	schwarz black zwart noir	braun brown bruin brun	beige beige beige beige
15	15 mm	•	•	•	•	•	•	•
20	20 mm	•	•	•	•	•	•	•
25	25 mm	•	•	•	•	•	•	•
30	30 mm	•	•	•	•	•	•	•
35	35 mm	•	•	•	•	•	•	•
40	40 mm	•	•	•	•	•	•	•
50	50 mm	•	•	•	•	•	•	•
60	60 mm	•	•	•	•	•	•	•

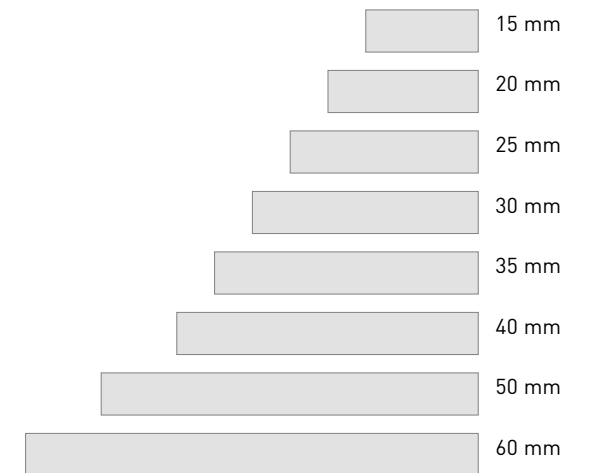
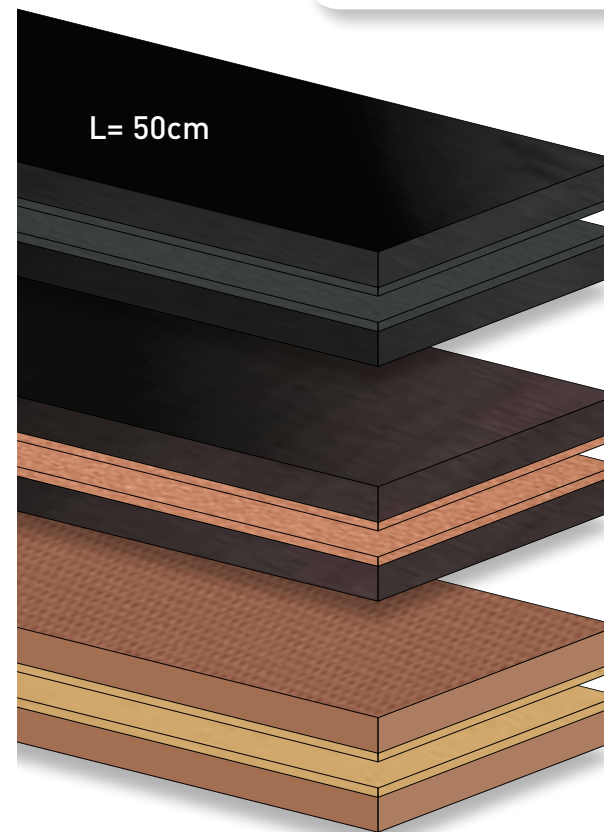

2.03

STREIFEN
STRIPES
STROKEN
BANDES DÉCOUPÉS

DUO-TOP 1355.

10

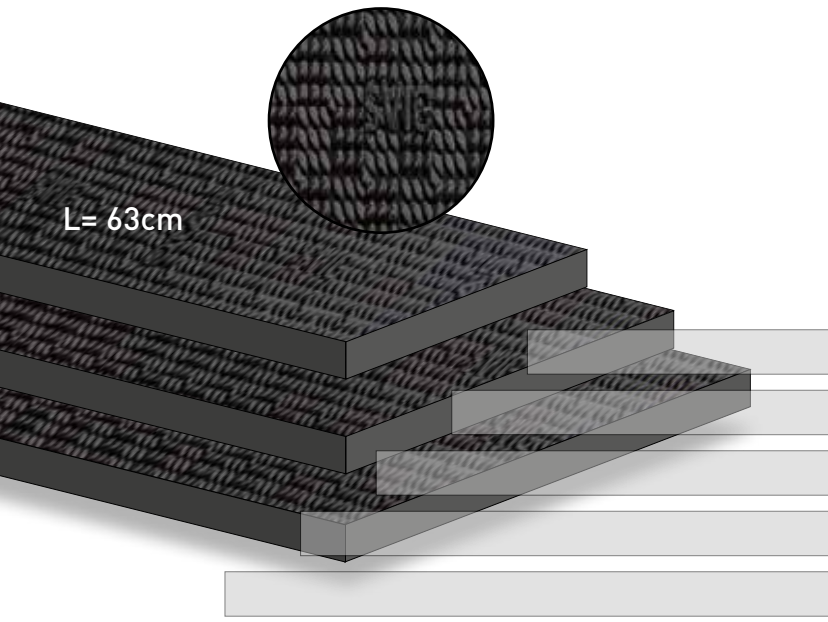

		6		
		6 mm		
		0	1	7
		schwarz black zwart noir	braun brown bruin brun	karamell toffee karamel caramel
40	40 mm	•	•	•
50	50 mm	•	•	•
60	60 mm	•	•	•
70	70 mm	•	•	•
80	80 mm	•	•	•

GUM-TOP 1352.

10

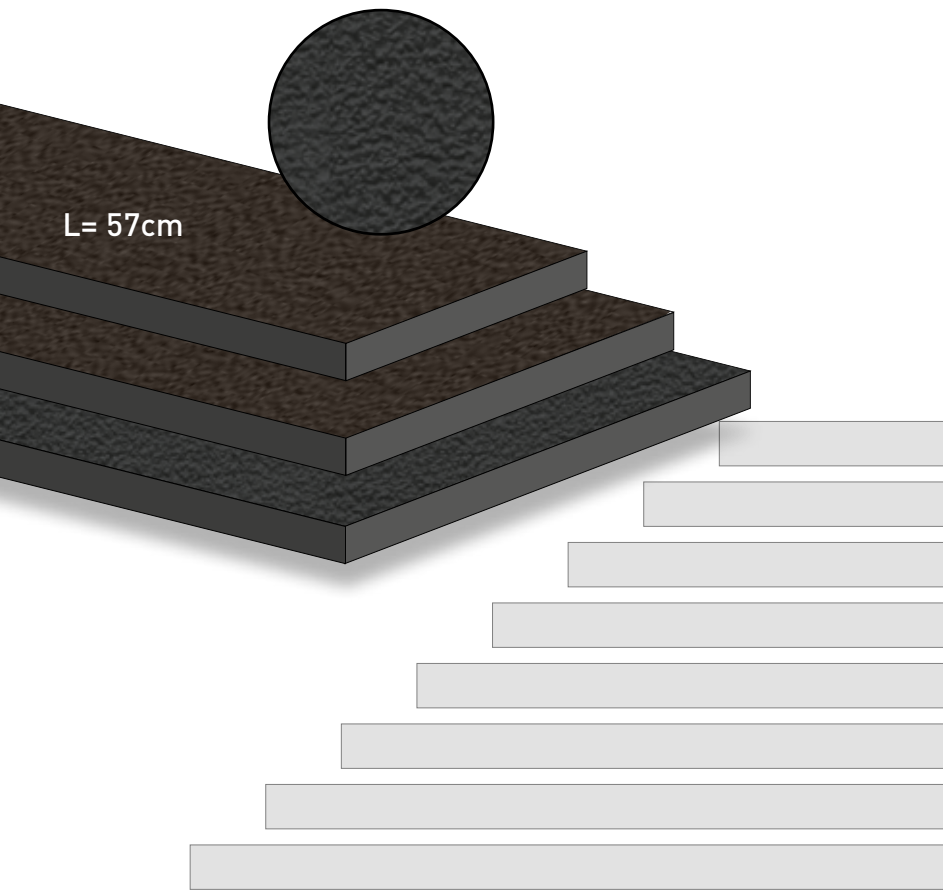

		6	
		6 mm	
		0	1
		schwarz black zwart noir	braun brown bruin brun
30	30 mm	•	•
40	40 mm	•	•
50	50 mm	•	•
60	60 mm	•	•
70	70 mm	•	•
80	80 mm	•	•
90	90 mm	•	•
99	100 mm	•	•

2.04

KEILSTREIFEN
RUBBER STRIPES
SCHUINE STROKEN
BANDES BISEAUTÉES

CREPINA 1431.

1

ABSATZ - HEEL - HAK - TALON

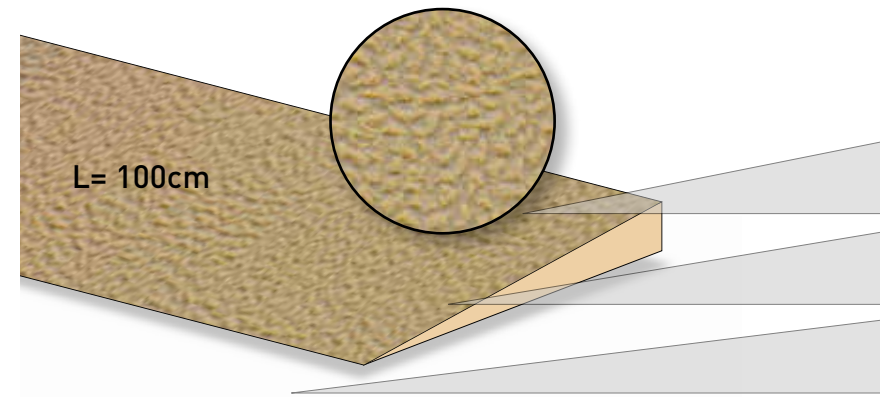

		→ page 2.8	
		in 5 Farben all 5 colours alle 5 kleuren les 5 couleurs	
		105, 109, 135, 146, 181	
05	10 x 50 mm	•	
06	10 x 60 mm	•	
08	10 x 80 mm	•	

CROWN 1421.

1

ABSATZ - HEEL - HAK - TALON

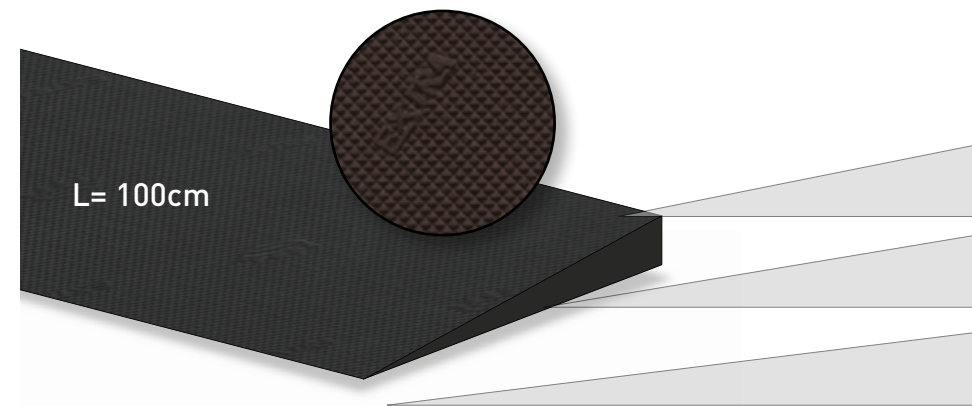

		0	1
		schwarz black zwart noir	braun brown bruin brun
05	10 x 50 mm	•	•
06	10 x 60 mm	•	•
08	10 x 80 mm	•	•

STRONG 1441.

1

ABSATZ - HEEL - HAK - TALON

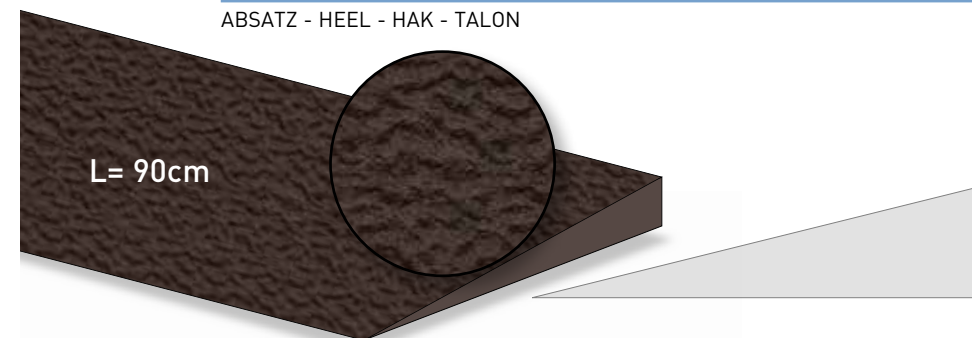

		0	1
		schwarz black zwart noir	braun brown bruin brun
06	15 x 60 mm	•	•

TRESS 1410.



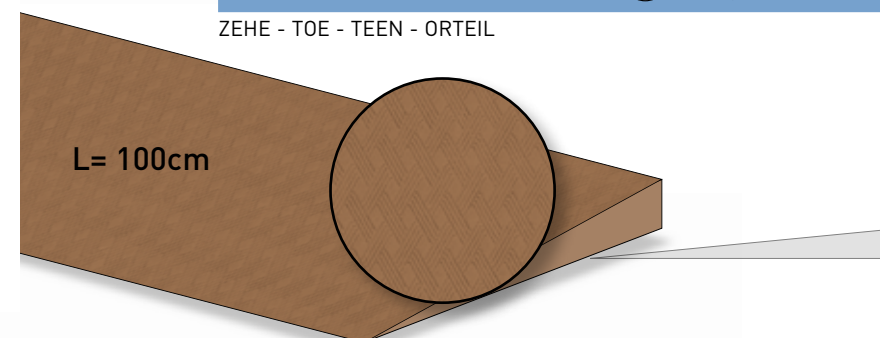

1

ZEHE - TOE - TEEN - ORTEIL



		0	1	4
		schwarz black zwart noir	braun brown bruin brun	beige beige beige beige
44	4 x 40 mm	•	•	•

LAURA 1502.  20p.

	2 Damen breit 'D-L' women wide dames breed dames large 39-41	5 Herren normal men normal heren normaal hommes normal 43-46	6 Herren breit 'L' men wide heren breed hommes large 43-46
	0 schwarz black zwart noir	1 braun brown bruin brun	7 d.beige d. beige beige f.
	0 schwarz black zwart noir	1 braun brown bruin brun	7 d. beige d. beige beige f.
	0 schwarz black zwart noir	1 braun brown bruin brun	7 d. beige d. beige beige f.

20	2,0 mm	•	•	•	•	•	•	•	•	•
25	2,5 mm	•	•	•	•	•	•	•	•	•
30	3,0 mm	•	•	•	•	•	•	•	•	•
40	4,0 mm	•	•	•	•	•	•	•	•	•

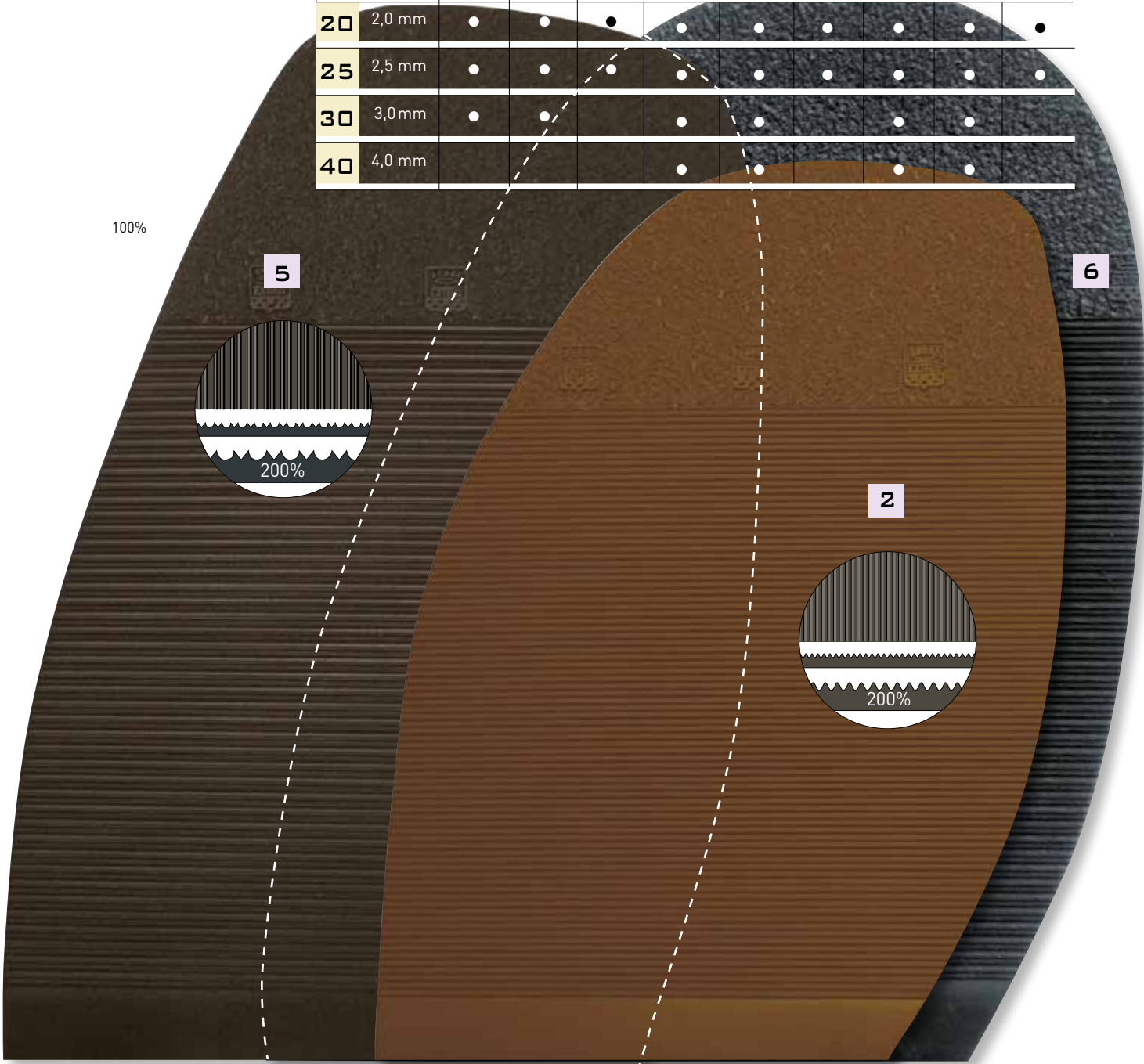

MONTE ROSA 1503.  20p.

3,5 mm





	0 schwarz black zwart noir	1 braun brown bruin brun	7 karamell toffee karamel caramel
03	3	•	•
05	5	•	•



FLYING MAN 15039.  20p.

3,5 mm



	0 schwarz black zwart noir	
	5 Herren normal men normal heren normaal hommes normal 43-46	6 Herren extra breit men extra wide heren extra breed hommes extra large 43-46
	35 3,5 mm	•

2.05
 1/2 SOHLEN
 1/2 SOLES
 1/2 ZOLEN
 1/2 SEMELLES

DUO-TOP 1507.

Vielfalt von 2 Platten (links/rechts) pro Größe
 Produced per 2 sheets (left/right) per size
 Veelvoud van 2 platen (links/rechts) per maat
 Production par 2 plaques (gauche/droite) par taille



18	1,8 mm	□ > 6		
		in 8 Größe DO bis H6 all 8 sizes DO to H6 alle 8 maten DO tot H6 les 8 pointures DO jusqu' à H6		
		□	1	7
		schwarz black zwart noir	braun brown bruin brun	karamell toffee karamel caramel
		●	●	●

CROWN 1505.

20p.

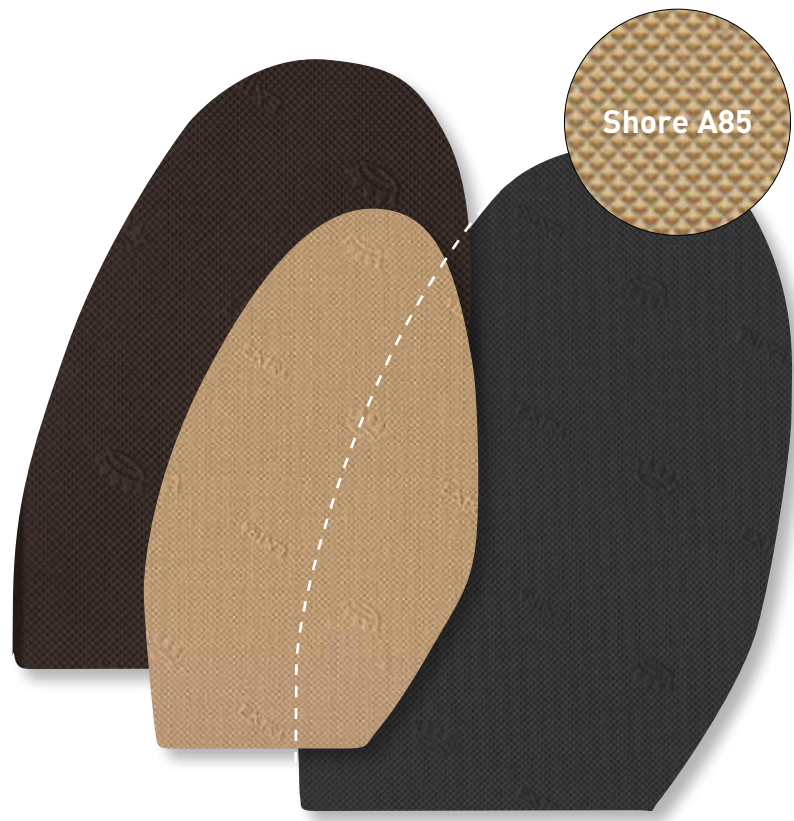

18	1,8 mm	□ > 6		
		in 8 Größe DO bis H6 all 8 sizes DO to H6 alle 8 maten DO tot H6 les 8 pointures DO jusqu' à H6		
		□	1	4
		schwarz black zwart noir	braun brown bruin brun	beige beige beige beige
		●	●	●
25	2,5 mm	●	●	●
30	3,0 mm	●	●	
35	3,5 mm	●	●	
40	4,0 mm	●	●	
50	5,0 mm	●	●	

(1/2) SOHLEN
 (1/2) SOLES
 (1/2) ZOLEN
 (1/2) SEMELLES

CREPINA SOFT 1508.

Vielfalt von 2 Platten (links/rechts) pro Größe
 Produced per 2 sheets (left/right) per size
 Veelvoud van 2 platen (links/rechts) per maat
 Production par 2 plaques (gauche/droite) par taille



20	2 mm	□ > 6		
		in 8 Größe DO bis H6 all 8 sizes DO to H6 alle 8 maten DO tot H6 les 8 pointures DO jusqu' à H6		
		□	1	
		in 16 Farben all 16 colours alle 16 kleuren toutes les 16 clrs	schwarz black zwart noir	braun brown bruin brun
		●		
30	3 mm		●	●
40	4 mm	●		
50	5 mm		●	●
60	6 mm	●		

20	2 mm	E F	
		Länge 31cm length 31cm lengte 31cm longueur 31cm	
40	4 mm	Länge 35cm length 35cm lengte 35cm longueur 35cm	
		16 Farben/colours/ kleuren/ couleurs	
		●	
		●	
60	6 mm	●	

FEATHER 152.7180.

91 x 58 cm

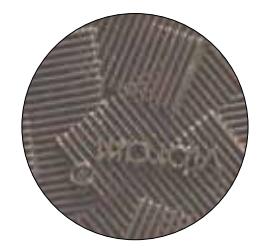
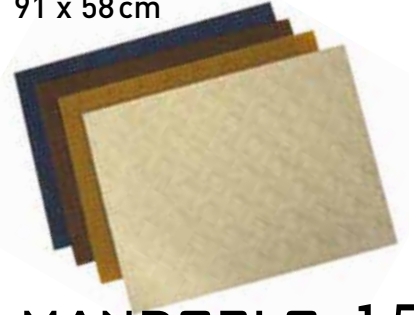

		40
		4 mm
□	■	●
1	■	●

MANDORLO 152.8316.

126 x 70 cm

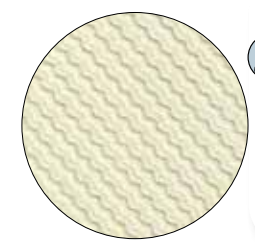
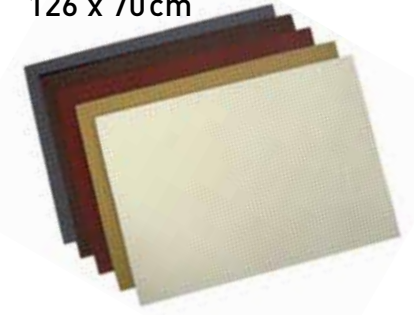

		050	060	080	100
		5 mm	6 mm	8 mm	10 mm
□	■	●	●	●	●
1	■	●	●	●	●

CLIVIA 152.8350.

126 x 70 cm

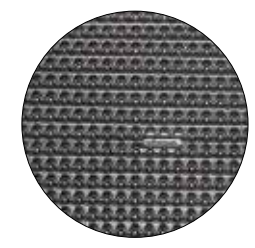
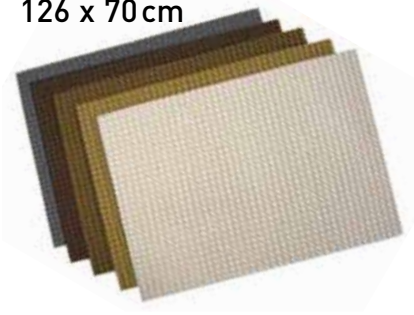

		60	80
		6 mm	8 mm
□	■	●	●
1	■	●	●

TEQUILGEMMA 152.7673.

112 x 85 cm

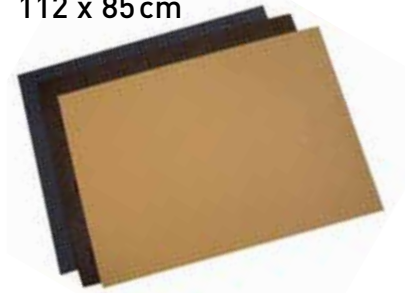

		18
		1,8 mm
□	■	●
1	■	●

GRIP 152.75.

93 x 64 cm

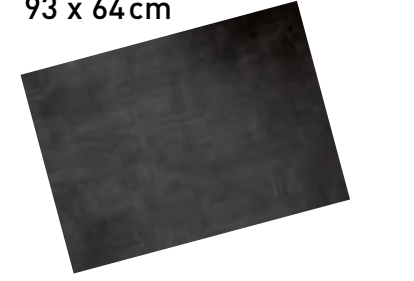

		20	40
		2 mm	4 mm
100	■	●	
090	■		●

■ schwarz black zwart noir
 ■ braun brown bruin brun
 ■ beige beige beige beige
 □ weiß white wit blanc

DUPLA 152.7179.

56 x 85 cm

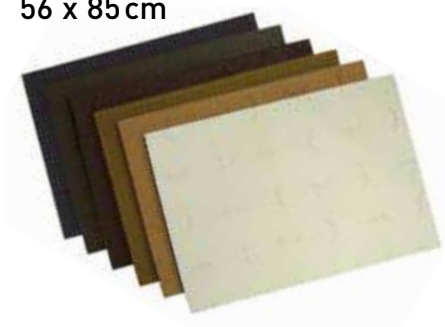

		050	060
		5 mm	6 mm
□	■	●	●
1	■	●	●
4	■	●	●
6	□		●
75	■		●
		capuccino	

CILIEGIO MORFLEX 152.8365.

126 x 80 cm

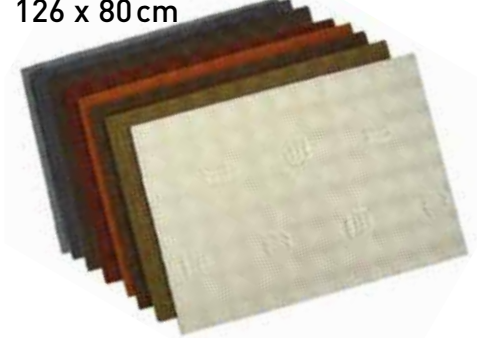

		060	080
		6 mm	8 mm
□	■	●	●
1	■	●	●
6	□	●	

NEWFLEX 152.8860.

90 x 65 cm

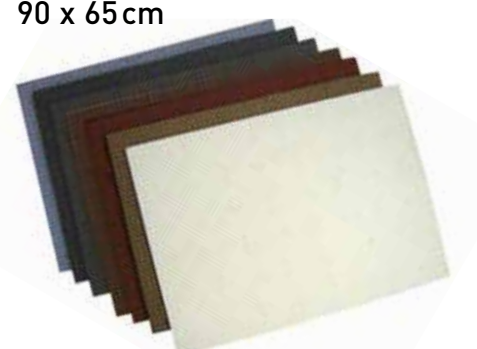

		040	060	080	100
		4 mm	6 mm	8 mm	10 mm
□	■	●	●	●	●
1	■		●	●	●

SUPER NEWFLEX 152.8868.

91 x 58 cm



		40	60
		4 mm	6 mm
□	■	●	●
1	■	●	●
4	■	●	●

2.06

PLATTEN
SHEETS
PLATEN
PLAQUES

VIBRAM



SIXTY 152.7149.

91 x 58cm

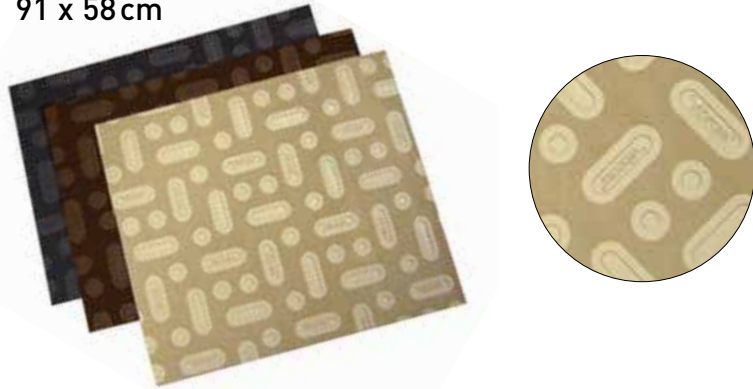

		30
		3mm
□	■	●
1	■	●
4	■	●

GEMMA 152.7163.

56 x 85cm

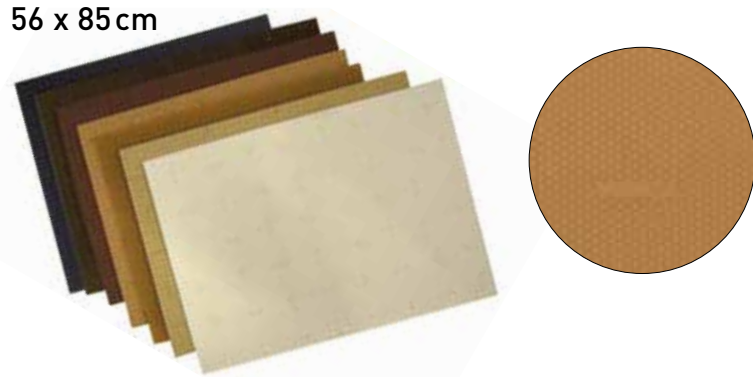

		30	40	60
		3mm	4mm	6mm
□	■			●
1	■			●
7	■	●	●	

CHERRY 152.7175.

91 x 58cm

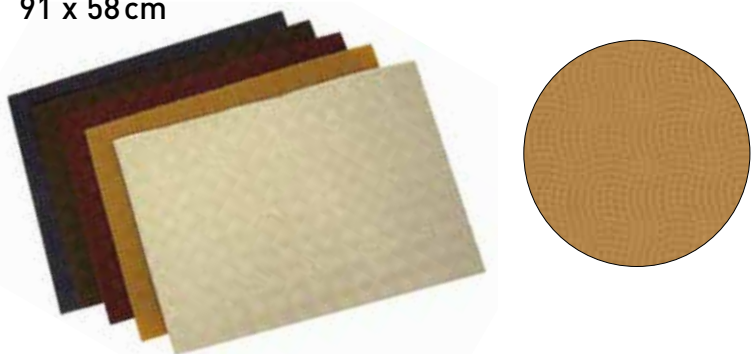

		40	60
		4mm	6mm
□	■	●	●
1	■	●	●
4	■	●	●

COMP NUVOLA 750P 152.750P.

56 x 85cm

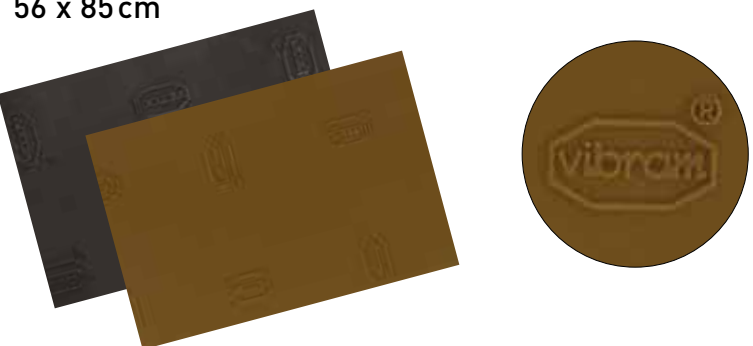

		060
		6mm
□	■	●
1	■	●
4	■	●

2.07

1/1 SOHLEN
1/1 SOLES
1/1 ZOLEN
1/1 SEMELLES

VIBRAM

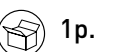

WINTER CITY 152.056C.

NEU
NEW
NIEUW
NOUVEAU



		38	40	42	44	46
		38	40	42	44	46
□	■	●	●	●	●	●

BREITHORN 152.1012.



		39	41	43	45	47
		39/40	41/42	43/44	45/46	47/48
□	■	●	●	●	●	●

TETON 152.1014.



		37	39	41	43	45
		37/38	39/40	41/42	43/44	45/46
□	■	●	●	●	●	●

IZALCO 152.1030.



		36	38	40	42	44	46
		36/37	38/39	40/41	42/43	44/45	46/47
□	■	●	●	●	●	●	●
1	■	●	●	●	●	●	●

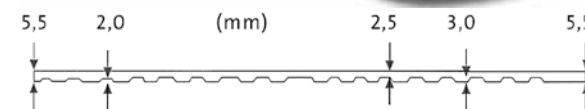

ROCCIA UOMO 152.1105/s.



		35	37	39	41	43	45	47
		35/36	37/38	39/40	41/42	43/44	45/46	47/48
□	■	●	●	●	●	●	●	●

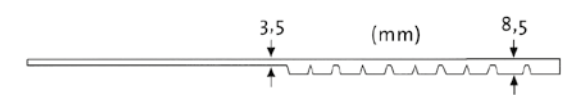

→ page 2.29

MONTAGNA BLOCK 152.1132.

Grip

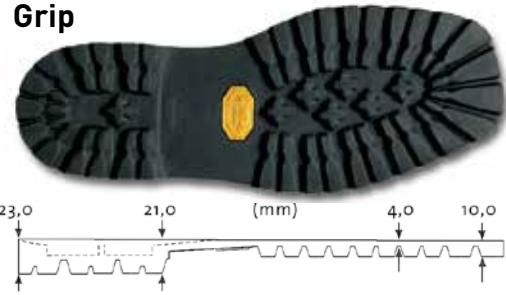

	35	37	39	41	43	45	47	49	51
	35/36	37/38	39/40	41/42	43/44	45/46	47/48	49/50	51/52
□	●	●	●	●	●	●	●	●	●
1	●	●	●	●	●	●	●	●	●

SASS MAOR 152.1230.



	41	43	45
	41/42	43/44	45/46
□	●	●	●

MONTAGNA BLOCK 152.1133.

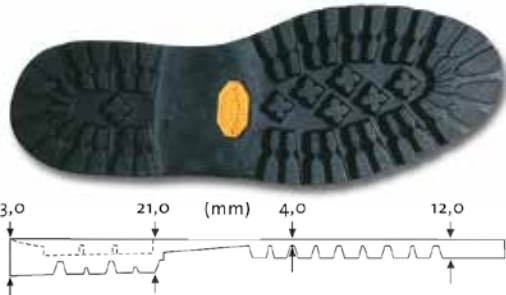

	33	35	37	39	41	43	45	47
	33/34	35/36	37/38	39/40	41/42	43/44	45/46	47/48
□	●	●	●	●	●	●	●	●

USHBA 152.1485.



	38 > 46	47
	38 → 46	47,5
□	●	●

ROCCIA BLOCK 152.1136.

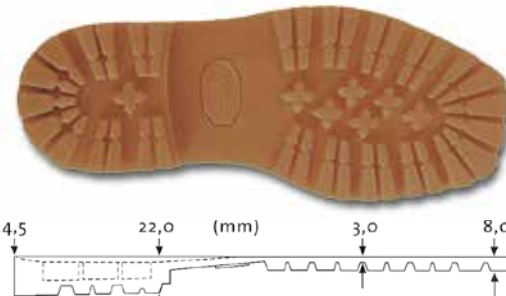

	35	37	39	41	43	45	47	49
	35/36	37/38	39/40	41/42	43/44	45/46	47/48	49/50
4	●	●	●	●	●	●	●	●

MOMBELLO 152.1685.



	078	091	113
	41/42	43/45	46/48
□	●	●	●

MONTAGNA BL.29 152.1149.

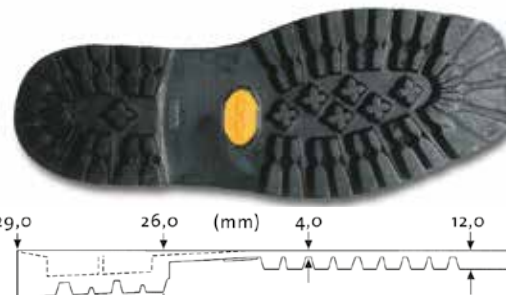

	35	37	39	41	43	45	47	49
	35/36	37/38	39/40	41/42	43/44	45/46	47/48	49/50
□	●	●	●	●	●	●	●	●

CAMBRIDGE 152.2002.

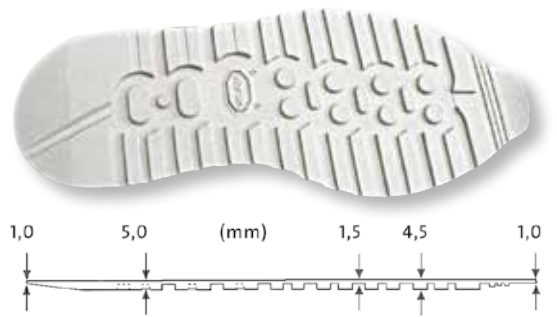

	030	050	070	090	110	130
	35/37	38/40	41/42	43/44	45/46	47/48
□	●	●	●	●	●	●
6	●	●	●	●	●	●

JANKUAT 152.1220.

Grip

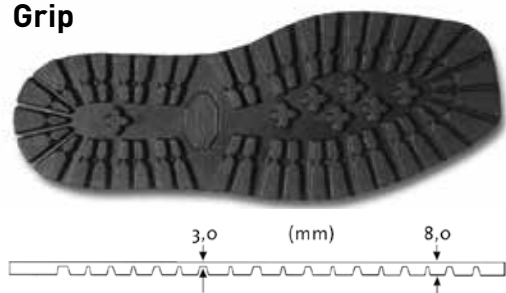

	35	37	39	41	43	45	47
	35/36	37/38	39/40	41/42	43/44	45/46	47/48
□	●	●	●	●	●	●	●
1	●	●	●	●	●	●	●

ETON 152.2055S.



	05	07	09	11	13
	38/40	41/42	43/44	45/46	47/48
□	●	●	●	●	●
1	●	●	●	●	●

→ page 2.29

LIENZ 152.2094.



	05	07	09	11
	38/40	41/42	43/44	45/46
□	●	●	●	●
1	●	●	●	●

LIVERPOOL 152.2600.

gumlite®



	35	37	39	41	43	45	47
	35/36	37/38	39/40	41/42	43/44	45/46	47/49
□	●	●	●	●	●	●	●
1	●	●	●	●	●	●	●

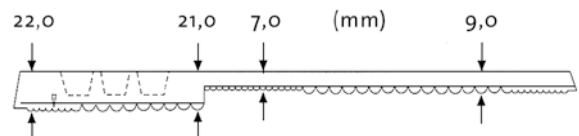

ATHENA 152.2609.

gumlite®



	unsize 39/46
□	●
1	●
4	●

ODESSA 152.2640.

gumlite®



	37	39	41	43	45
	37/38	39/40	41/42	43/44	45/46
□	●	●	●	●	●
1	●	●	●	●	●

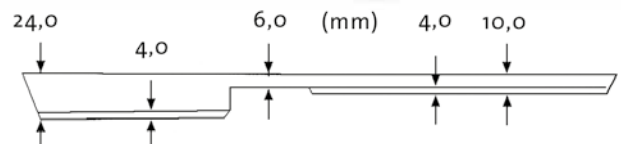

DURBAN 152.2644.

gumlite®



	35	37	39	41	43	45
	35/36	37/38	39/40	41/42	43/44	45/46
□	●	●	●	●	●	●
1	●	●	●	●	●	●

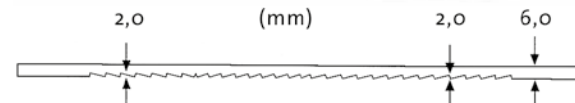

LIPSIA 152.2653.

gumlite®



	41	45
	41/44	45/47
□	●	●

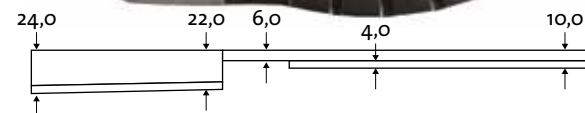

SPRINGS 152.2655/S.

gumlite®



	35	37	39	41	43	45	47
	35/36	37/38	39/40	41/42	43/44	45/46	47/48
□	●	●	●	●	●	●	●
1	●	●	●	●	●	●	●

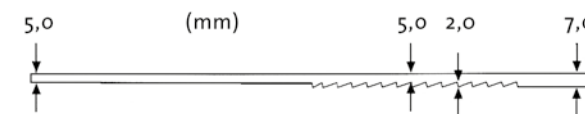

FUNKY ORTHO 152.2667.

gumlite®



	41	45
	41/44	45/47
□	●	●
1	●	●

2.07

1/1 SOHLEN
1/1 SOLES
1/1 ZOLEN
1/1 SEMELLES

VIBRAM

1p.

HEIDELBERG 152.2668.

gumlite®

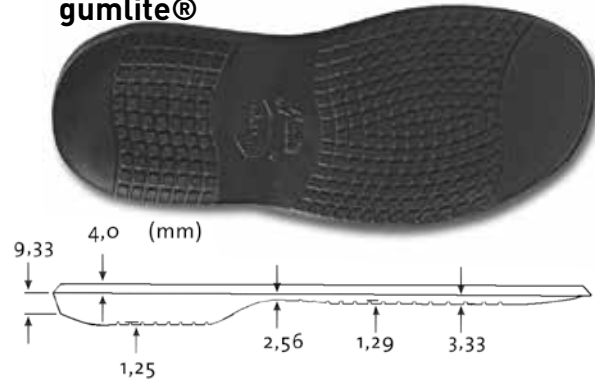

	37	39	41	43	45	47
	37/38	39/40	41/42	43/44	45/46	47/48
□	●	●	●	●	●	●
1	●	●	●	●	●	●
4	●	●	●	●	●	●

MINSK 152.2678.

Grip



	37	39	41	43	45
	37/38	39/40	41/42	43/44	45/46
□	●	●	●	●	●
1	●	●	●	●	●

AQUAGUM DONNA 152.2690.



	35	39	43
	35/38	39/42	43/46
□	●	●	●
1	●	●	●

AQUAGUM UOMO 152.2691.



	39	43
	39/42	43/46
□	●	●
1	●	●

2.08

1/2 SOHLEN
1/2 SOLES
1/2 ZOLEN
1/2 SEMELLES

VIBRAM

1p.

SIMON 152.2027.



	39	43	47
	39/42	43/46	47/50
□	●	●	●
1	●	●	●

MORTARA 152.2333.



	41	43	45	47
	41/42	43/44	45/46	47/50
□	●	●	●	●
1	●	●	●	●
4	●	●	●	●
7	●	●	●	●

ANGERA 152.2336.



	35	38	41	44	47
	35/37	38/40	41/43	44/46	47/50
□	●	●	●	●	●
1	●	●	●	●	●
4	●	●	●	●	●

STRESA 152.2337.



	39	43	47	49
	39/42	43/46	47/48	49/52
□	●	●	●	●
1	●	●	●	●

SIMONA 152.3928.



	34	37	40
	34/36	37/39	40/42
□	●	●	●
1	●	●	●

schwarz
 black
 zwart
 noir

braun
 brown
 bruin
 brun



beige
 beige
 beige
 beige

karamell
 toffee
 karamel
 caramel

GRIZZLY 152.2024. 1p.

1/2 SOHLE - 1/2 SOLE - 1/2 ZOOL - 1/2 SEMELLE



		01 nr1	03 nr3
<input type="checkbox"/>	<input type="checkbox"/>	<input type="checkbox"/>	<input type="checkbox"/>

GRIZZLY 152.5424. 1p.





FORMABSATZ - MOULDED HEEL - GEVORMDE HAK - TALON MOULÉ



ARIEL 152.2342. 1p.

gumlite® 1/2 SOHLE - 1/2 SOLE - 1/2 ZOOL - 1/2 SEMELLE



	00	01	03
			
	00	01	03
<input type="checkbox"/>	<input type="checkbox"/>	<input type="checkbox"/>	<input type="checkbox"/>
1	<input type="checkbox"/>	<input type="checkbox"/>	<input type="checkbox"/>
4	<input type="checkbox"/>	<input type="checkbox"/>	<input type="checkbox"/>
6	<input type="checkbox"/>	<input type="checkbox"/>	<input type="checkbox"/>

ARIEL 152.5342. 1p.

gumlite® FORMABSATZ - MOULDED HEEL - GEVORMDE HAK - TALON MOULÉ



2.09

FORMABSÄTZE
MOULDED HEELS
GEVORMDE HAKKEN
TALONS MOULÉS

VIBRAM

ROCCIA 152.1105/T. 1p.

Grip

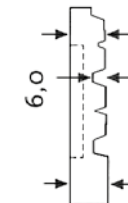

	33	36	39	41	43	45
	33/35	36/38	39/40	41/42	43/44	45/47
<input type="checkbox"/>	<input type="checkbox"/>	<input type="checkbox"/>	<input type="checkbox"/>	<input type="checkbox"/>	<input type="checkbox"/>	<input type="checkbox"/>

ROCCIA 152.1205. 1p.

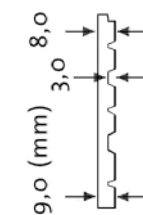

	39	41	43	45	48
	39/40	41/42	43/44	45/47	48/50
<input type="checkbox"/>	<input type="checkbox"/>	<input type="checkbox"/>	<input type="checkbox"/>	<input type="checkbox"/>	<input type="checkbox"/>
1	<input type="checkbox"/>	<input type="checkbox"/>	<input type="checkbox"/>	<input type="checkbox"/>	<input type="checkbox"/>
4	<input type="checkbox"/>	<input type="checkbox"/>	<input type="checkbox"/>	<input type="checkbox"/>	<input type="checkbox"/>
7	<input type="checkbox"/>	<input type="checkbox"/>	<input type="checkbox"/>	<input type="checkbox"/>	<input type="checkbox"/>

ETON 152.2055T. 1p.



	05	07	09	11	13
	05/06	07/08	09/10	11/12	13/14
<input type="checkbox"/>	<input type="checkbox"/>	<input type="checkbox"/>	<input type="checkbox"/>	<input type="checkbox"/>	<input type="checkbox"/>
1	<input type="checkbox"/>	<input type="checkbox"/>	<input type="checkbox"/>	<input type="checkbox"/>	<input type="checkbox"/>

SPRINGS 152.2655/T. 1p.

gumlite®

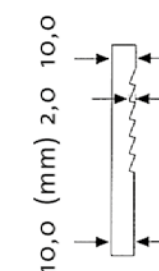

	35	37	39	41	43	45
	35/36	37/38	39/40	41/42	43/44	45/46
<input type="checkbox"/>	<input type="checkbox"/>	<input type="checkbox"/>	<input type="checkbox"/>	<input type="checkbox"/>	<input type="checkbox"/>	<input type="checkbox"/>
1	<input type="checkbox"/>	<input type="checkbox"/>	<input type="checkbox"/>	<input type="checkbox"/>	<input type="checkbox"/>	<input type="checkbox"/>

2.09

FORMABSÄTZE
MOULDED HEELS
GEVORMDE HAKKEN
TALONS MOULÉS

VIBRAM

EXPLOSION 152.5340. 1p.



	20	40
	020	040
□	●	●
1	●	●

TOP 152.5350. 1p.



	M00	M01	M02	M03	M04
	M00	M01	M02	M03	M04
□	●	●	●	●	●
1	●	●	●	●	●
4	●	●			

MARTA 152.5721. 1p.



	M01	M02	M03	M04
	M01	M02	M03	M04
□	●	●	●	●
1	●	●	●	●
4	●	●	●	●

2.10

PROFILLANGSOHLEN
PROFILE LONG SOLES
PROFIELZOLEN
SEMELLES PROFILÉES

YETI 1530. 1



orthopädic
orthopaedic
orthopedisch
orthopédique

	UNISIZE	
	0	1
□	schwarz black zwart noir	braun brown bruin brun
1	●	●
2	●	●

B-TECH 1540. 1



	00	01	03	04	05	07	09
□	●	●	transp.	●	●	●	●
02	35cm	●	●	●	●	●	●

SCOOTER 1541. 1



	36	39	42	45	48
	36/38	39/41	42/44	45/47	48/50
□	●	●	●	●	●
03	transp.	●	●	●	●

URBAN 1542. 1



	02	03
	31,5cm	35,5cm
□	●	●
03	transp.	●

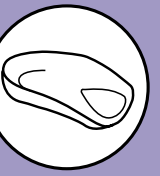

**FRÄSTECHNIK, EINLAGEN-ROHLINGE
MILLING TECHNIQUES, ORTHOPEDIC FOOT SUPPORTS
FREESTECHNIEK, STEUNZOLEN
TECHNIQUE À FRAISER, SEMELLES ORTHOPÉDIQUES**

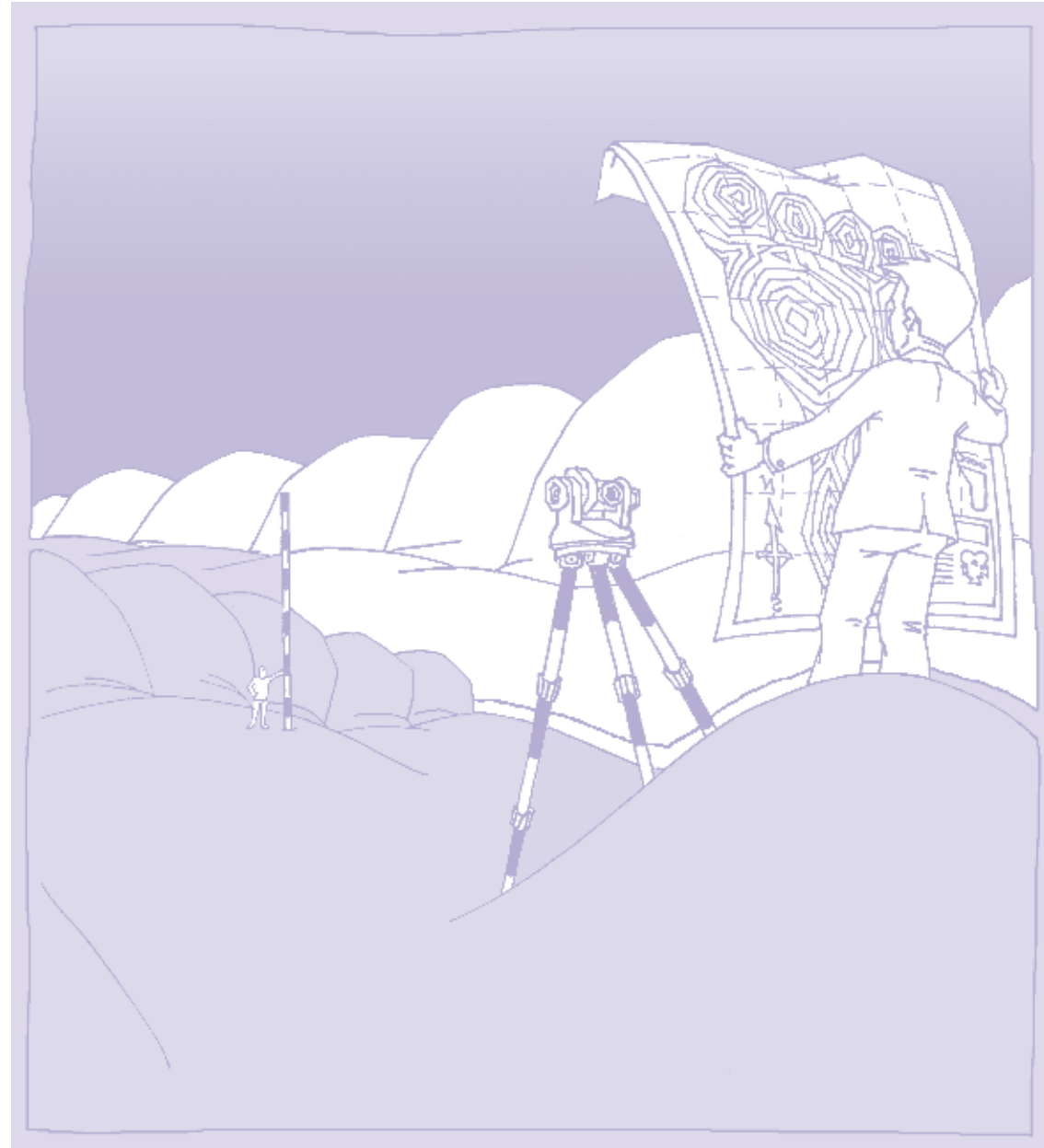

3.01	FRÄSTECHNIK MILLING TECHNIQUES FREESTECHNIEK TECHNIQUE A FRAISER	3.2
3.02	D3D-CONCEPT DYNAMIC 3-DIMENSIONAL CONCEPT	3.16
3.03	EIGENE PRODUKTION OUR OWN PRODUCTION EIGEN FABRIKAAT PROPRE FABRICATION	
	SPORT	3.24
	ELEGANT	3.28
	CORK/(WALK)LEATHER	3.30
3.04	PELOTTEN - STÜTZEN - FERSENKISSEN PADS - SUPPORTS - HEELCUSHIONS PELOTTEN - INBOUWDELEN - HIELKUSSENS PELOTTES - SUPPORTS - TALONETTES	3.32
3.05	BIRKO SCHALENFORMEN BIRKO SHELL FORMS BIRKO SCHAALVORMEN BIRKO FORMES DE COQUILLE	3.44

AFT®
AFT-International.com

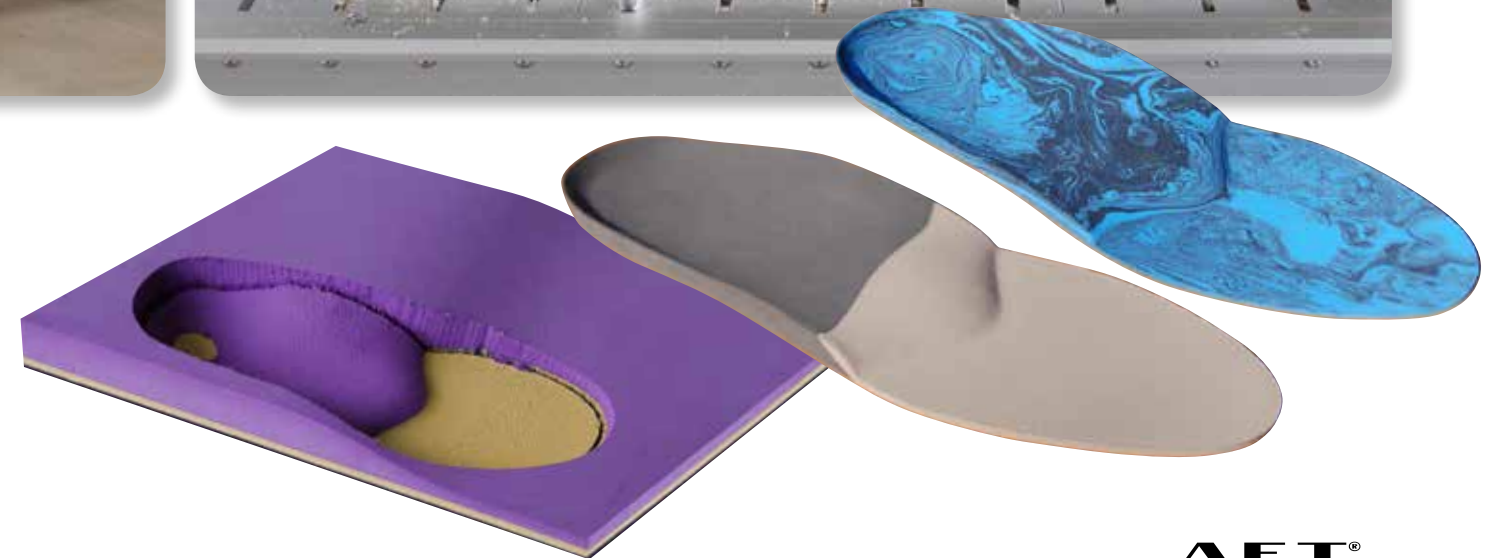
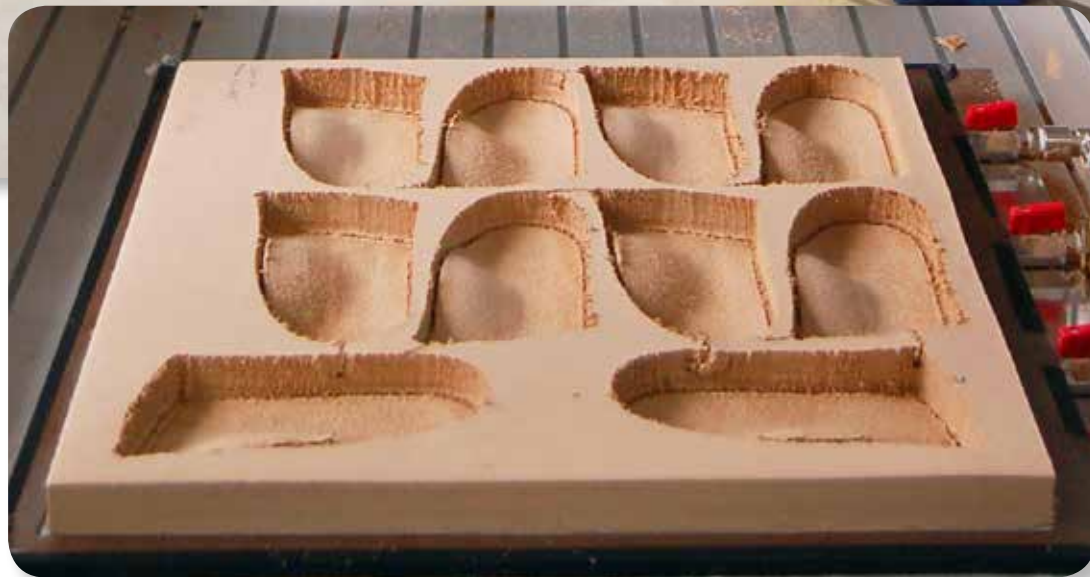

KEILE
STRIPES
STROKEN
BANDES

BLOCK
BLOCK
BLOK
BLOC

1/2 BLOCK
1/2 BLOCK
1/2 BLOK
1/2 BLOC

FRÄSROHLINGE
MILLING SOLES
FREESZOLEN
SEM. A FRAISER

END PRODUKT
END PRODUCT
EIND PRODUCT
PRODUIT FINAL

→ page 3.13

UNI-FORM

→ part 1

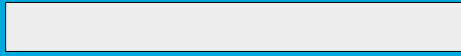

	15mm	20mm	25mm	30mm	35mm	40mm
shore	20→60	20→60	20→60	20→70	20→60	20→60

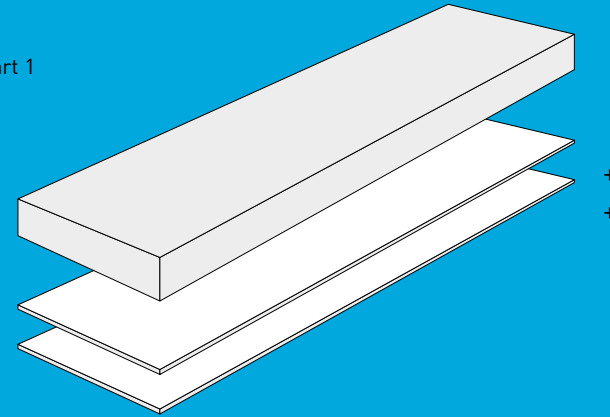

STANDARD*: 35 x 25 cm

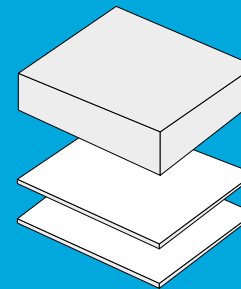

STANDARD*: 31 x 12,5 cm
35 x 13 cm

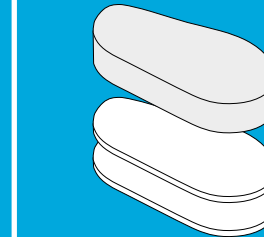
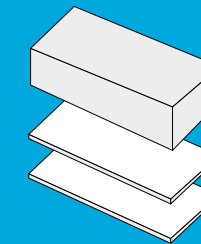

ORTHO-FORM

→ page 3.6



	30→60	30mm	5/25	
	60	35mm	8/27	
	30→50	40mm	10/30	

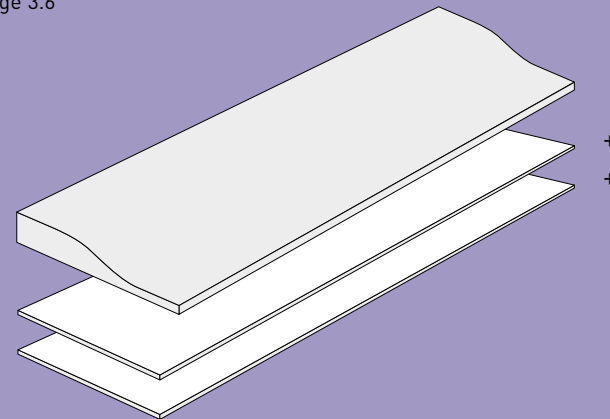

STANDARD*: 35 x 25 cm

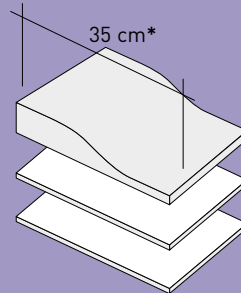

STANDARD*: 31 x 12,5 cm
35 x 13 cm

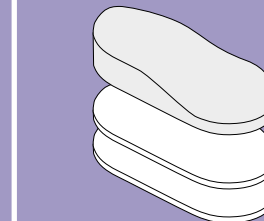
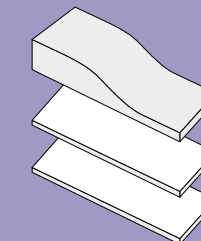

COMBI-FORM

→ page 3.10



	25mm	30mm
--	------	------

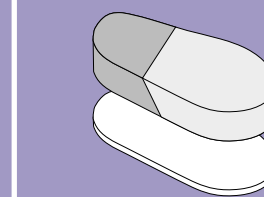
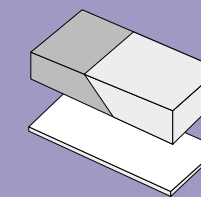
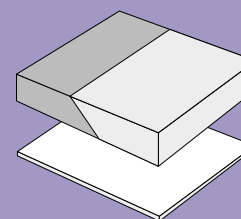
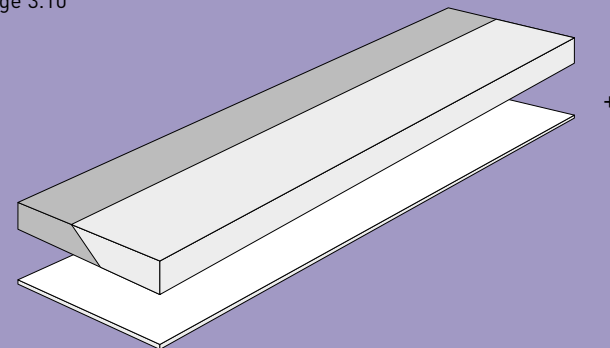

SPECIALS ('BROODJES')

→ page 3.12

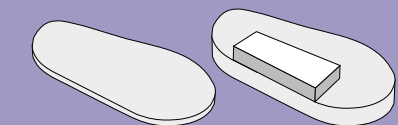

+ EXTRA COMFORT/STIFFENING/BOTTOM SOLE

→ page 3.7

* andere Abmessungen sind möglich
other dimensions are possible
andere afmetingen zijn mogelijk
autres dimensions sont possibles

ORTHO-FORM

Shore	EVACAD		EVASTAT		EVA CARBOSTAT		EVA MARBLE		EVA CORK	
	5/25 mm	10/30 mm	5/25 mm	10/30 mm	5/25 mm	10/30 mm	5/25 mm	10/30 mm	5/25 mm	10/30 mm
Shore 25		109 115								
Shore 30	187 198	187 198 178 109 176	109	109	181					
Shore 35	109			181						
Shore 40	121 109 181	121 181 115 109 178		189	181		32 45 38 48			
Shore 45		146 171	109 181 187	109 181 187						
Shore 50	128 146 181 178	128 121 181 178 101 114 106		187	181		38 45			
Shore 55										
Shore 60	178 181 146	8/27 mm!! 129 178 185	109 181 187							

shore	ELASTOFLEX		HIGHFLEX	
	5/25 mm	10/30 mm	5/25 mm	10/30 mm
15	101 176	101 176		
20	174	174		
25			172	172

shore	EXTRAFOAM (Extrafoam, Multicolour, Aqua, Marble)	SUPERSOFT SOFTAIR TERMOLAST
	25 bis to t/m à 60	5/25 mm

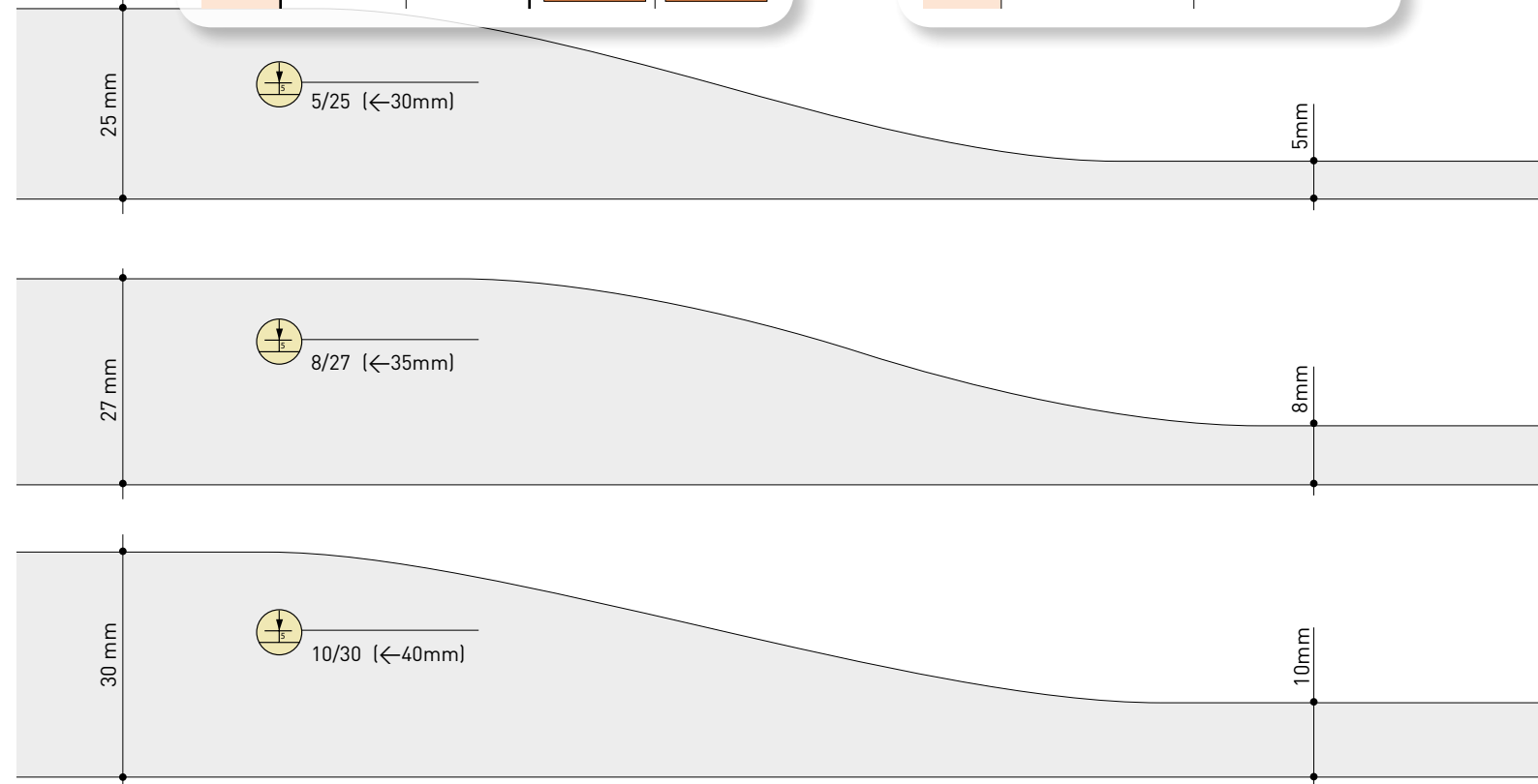

EXTRA COMFORT/STIFFENING

Wählen Sie falls erwünscht eine zweite Schicht für extra Komfort oder Verstärkung
Choose if desired a second layer for extra comfort or strengthening
Kies indien gewenst een tweede laag voor extra comfort of versterking
Choisissez si désiré une deuxième couche pour plus de confort ou renforcement



BRANDSOHL - BOTTOM SOLE - GROND PATROON - PREMIÈRE

Wählen Sie falls erwünscht ein Brandsohlenmaterial
Choose if desired a bottom sole material
Kies indien gewenst een materiaal voor grondpatronen
Choisissez si désiré un matériel pour premières



DURALUX beige	EVACAD Shore70
DURALUX black	HARDAIR Shore60
DURALITE beige	
1,2mm	2mm

Beispiele - exemples - voorbeelden - exemples

ORTHO-FORM

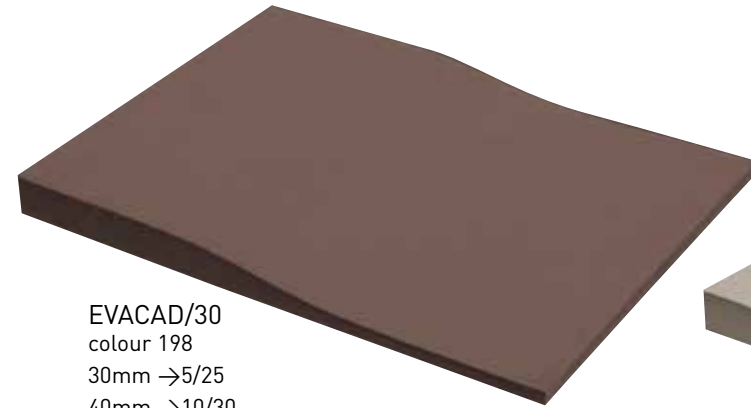

EVACAD/30
colour 198
30mm →5/25
40mm →10/30



EVACAD/40
colour 121
30mm →5/25
40mm →10/30



EVASTAT/45
colour 187
30mm →5/25
40mm →10/30



EVASTAT/30
colour 109
30mm →5/25
40mm →10/30

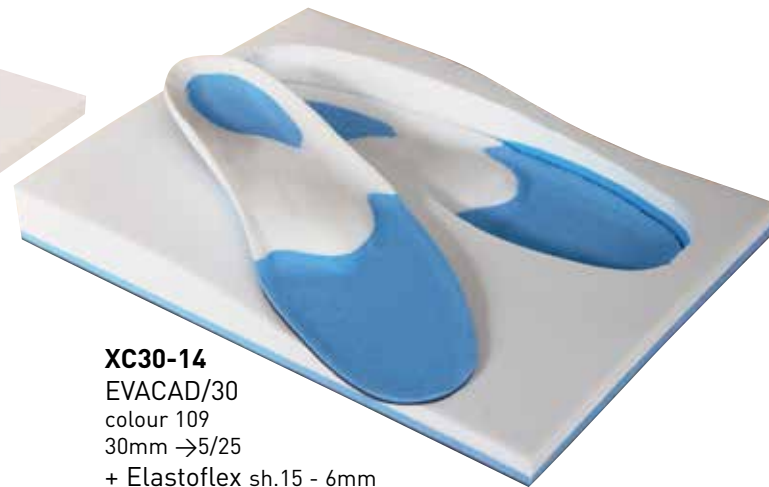

XC30-14
EVACAD/30
colour 109
30mm →5/25
+ Elastoflex sh.15 - 6mm
+ Evacad/70 - 2mm

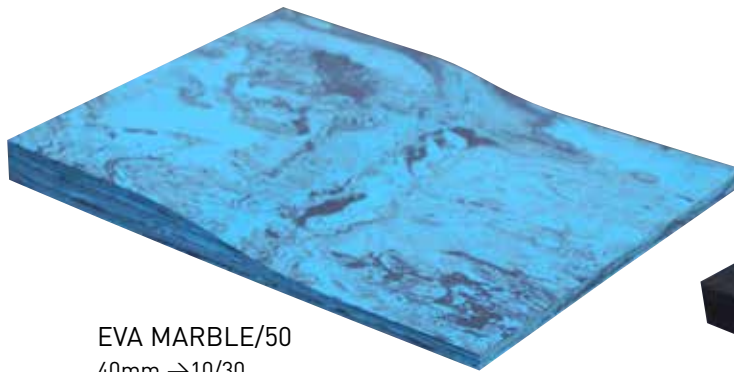

EVA MARBLE/50
40mm →10/30



EVA CARBOSTAT/30/40/50
40mm →10/30

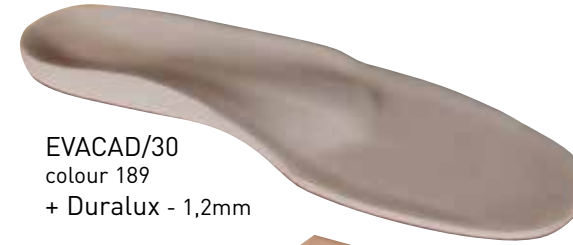

EVACAD/30
colour 189
+ Duralux - 1,2mm

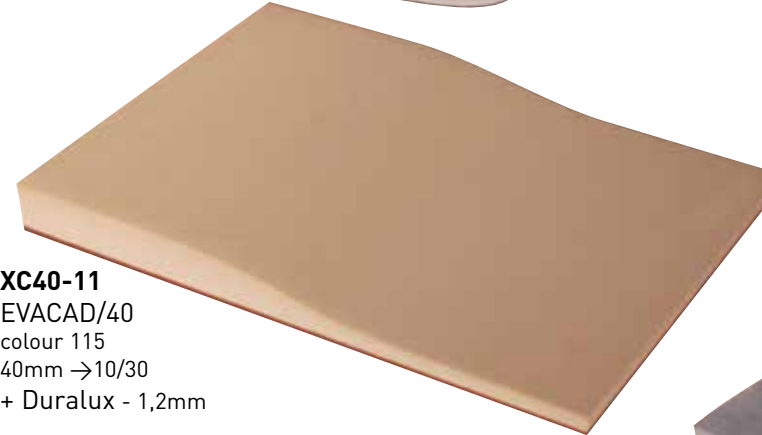

XC40-11
EVACAD/40
colour 115
40mm →10/30
+ Duralux - 1,2mm

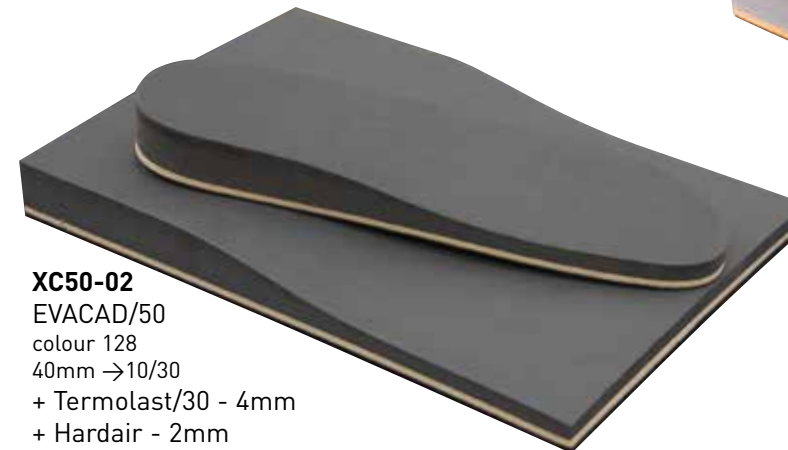

XC50-02
EVACAD/50
colour 128
40mm →10/30
+ Termolast/30 - 4mm
+ Hardair - 2mm

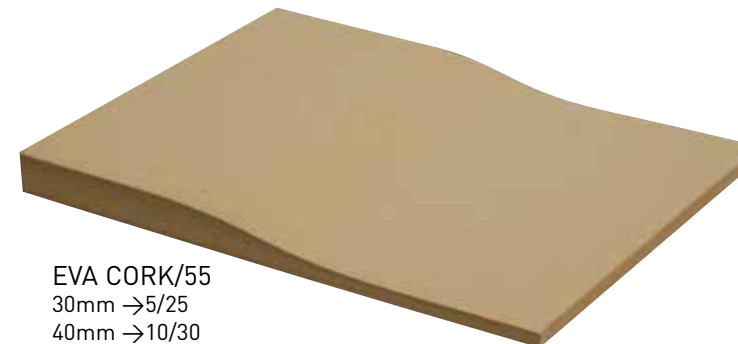

EVA CORK/55
30mm →5/25
40mm →10/30



XC40-33
EVACAD/40
colour 181
30mm →5/25
+ Elastoflex sh.20 - 5mm turquoise
+ Evacad/70 - 2mm



XC50-23
EVACAD/50
colour 128
30mm →5/25
+ Highflex sh.25 - 4mm
+ Evacad/70 - 2mm

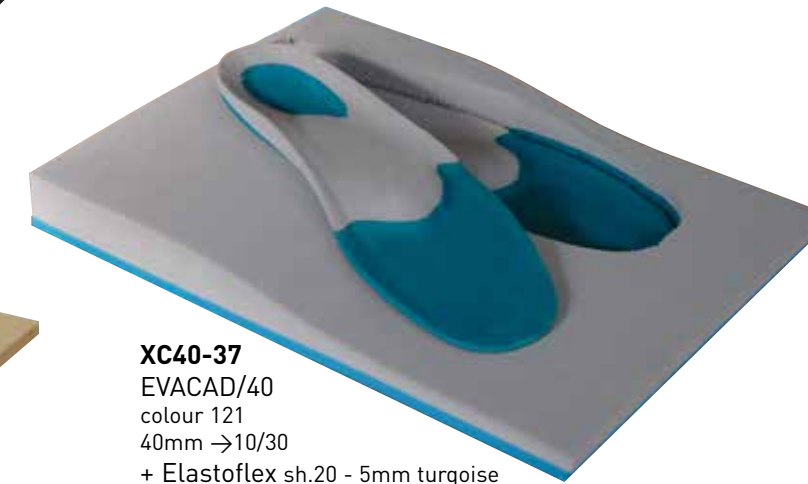

XC40-37
EVACAD/40
colour 121
40mm →10/30
+ Elastoflex sh.20 - 5mm turquoise
+ Evacad/70 - 2mm



EVACAD, EVASTAT

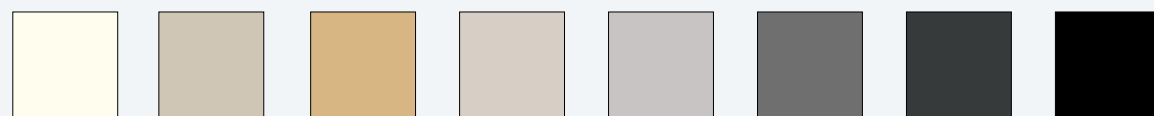

109	114	115	189	121	128	129	181
weiß white wit blanc	elfenbein ivory ivoor	beige beige beige	arena	hellgrau light grey lichtgrijs gris clair	dunkelgrau dark grey donkergrijs gris foncé	anthrazit anthracite antraciet anthracite	schwarz black zwart noir

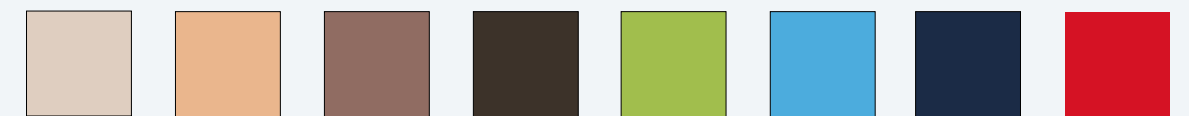

187	101	198	146	171	176	178	106
tierra	hautfarbe skin huidskleur couleur chair	otter otter loutre otter	dunkelbraun dark brown donkerbruin brun foncé	pistache	hellblau light blue lichtblauw bleu clair	dunkelblau dark blue donkerblauw bleu foncé	rot red rood rouge

COMBI-FORM

			KEILE STRIPES STROKEN BANDES	BLOCK BLOK BLOK BLOC	PDN GERADE PDN STRAIGHT PDN RECHT PDN DROIT	PDN DIAGONAL PDN DIAGONAL PDN DIAGONAAL PDN DIAGONAL
50/50%	25 or 30mm					
	30mm	1B7 shore 30	121 shore 40	32 x 180cm 71CS-103-32	32 x 25cm 77CS-103-0020	
	30mm	1B7 shore 30	121 shore 40	36 x 180cm 71CS-103-36	36 x 25cm 77CS-103-0063	
	30mm	1B7 shore 30	128 shore 50	32 x 175cm 71CS-101-32	32 x 25cm 77CS-101-0020	PDN2 77CS-101-00P2 32 x 25cm 77CS-101-02P2D
	30mm	1B7 shore 30	128 shore 50	36 x 175cm 71CS-101-36	36 x 25cm 77CS-101-0063	PDN3 77CS-101-00P3 36 x 25cm 77CS-101-02P3D
	30mm	121 shore 35	125 shore 50	36 x 175cm 71CS-108-39	36 x 25cm 77CS-108-0063	
	30mm	121 shore 40	128 shore 60	36 x 164cm 71CS-102-36	36 x 25cm 77CS-102-0063	
	30mm	121 shore 40	128 shore 60	40 x 164cm 71CS-102-40		
60/40%	25mm	109 shore 30	178 shore 50	31 x 175cm 71CY-501-31	31 x 25cm 77CY-501-0064	PDN2 77CY-501-00P2 31 x 25cm 77CY-501-02P2D
	25mm	109 shore 30	178 shore 50	36 x 175cm 71CY-501-36	36 x 25cm 77CY-501-0063	PDN3 77CY-501-00P3 36 x 25cm 77CY-501-02P3D
	25mm	109 shore 40	128 shore 60	31 x 164cm 71CY-502-31	31 x 25cm 77CY-502-0064	PDN2 77CY-502-00P2
	25mm	109 shore 40	128 shore 60	36 x 164cm 71CY-502-31	36 x 25cm 77CY-502-0063	PDN3 77CY-502-00P3
	30mm	176 (Elastoflex) shore 15	178 shore 35	33 x 190cm 71CY-505-33	33 x 25cm 77CY-505-0029	
	30mm	1B7 shore 30	146 shore 50	36 x 175cm 71CY-503-36	36 x 1cm 77CY-503-0125	
	30mm	198 shore 35	146 shore 55	33 x 168cm 71CY-506-33	33 x 25cm 77CY-506-0025	
	30mm					
SPECIAL TRIVULCANIZED	38→10mm	shore 45 - 30→2mm shore 25 - 6mm shore 55 - 2mm	35 x 160cm 71CV-450-135	33 x 25cm 77CV-450-129	77CV-450-129 TRIVULCANIZED	



Beispiele - examples - voorbeelden - exemples

SPECIALS

Diese 'Fräsblöcke' bestehen aus 1 oder mehrere Materialien in der jeweiligen Shore-Härte Ihrer Wahl, verklebt mit Brandsohlenmaterial wie z.B. Duralux.

These 'millingblocks' consist of 1 or more layers in materials of various shore values of your choice, glued on a bottom sole in for example Duralux.

Dit zijn 'freesblokken' bestaande uit 1 of meerdere lagen in verschillende materialen met een shorewaarde naar keuze, verlijmd op een grondpatroon in bv. Duralux.

Ce sont des 'blocs à fraiser' en 1 ou plusieurs couches (matières au choix), collé sur une matériel pour première, comme par exemple Duralux.



Alle Materialien (Shore + Stärke + Farbe) nach Wahl
All material (Shore + thickness + colour) of your choice
Alle materialen (Shore + dikte + kleur) naar keuze
Tous les matériaux (Shore + épaisseur + couleur) à votre choix

MILLING SOLES

FRÄSROHLINGE
FREESZOLEN
SEM. A FRAISER

BIO		35 > 50
FINN		35 > 48
PDN		1 > 3

Beispiele - examples - voorbeelden - exemples





HALBFABRIKAT SOHLEN
SEMI FINISHED INSOLES
HALFFABRIKAAT ZOLEN
DEMI-FABRICATION DES SEM. ORTHOP.

CAD-CAM

Beispiele - examples - voorbeelden - exemples

OHNE PELOTTE
WITHOUT PAD
ZONDER PELOT
SANS PELOTTE



20503
EVA CORK/45
+ Duralux



20505
EVA CORK/45
+ rundcrouete leather



20502
rubber cork
+ Duralux



20504
rubber cork
+ rundcrouete leather



7520513
EVACAD/60

MIT PELOTTE
WITH PAD
MET PELOT
AVEC PELOTTE



20523
EVA CORK/45
+ termolast retrocap. steun
+ rundcrouete leather



20589
EVA CORK/45
+ drop pad
+ Duralux 1,2mm + Reflex 3mm

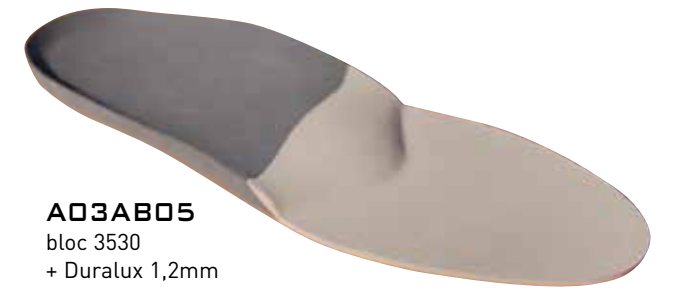

A03AB05
bloc 3530
+ Duralux 1,2mm

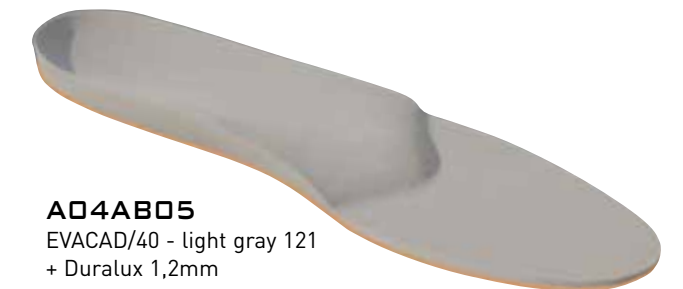

A04AB05
EVACAD/40 - light gray 121
+ Duralux 1,2mm

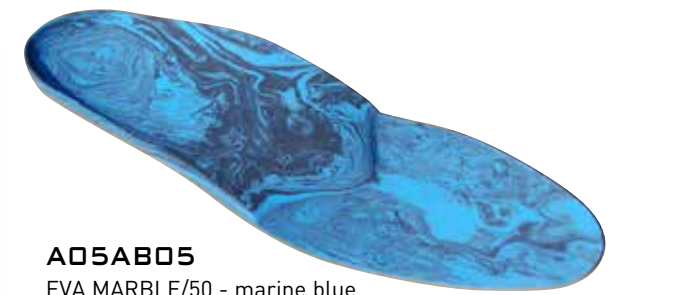

A05AB05
EVA MARBLE/50 - marine blue
+ Duralux 1,2mm



ORTHOPAEDIC

TWENTY12



DYNAMIC 3-DIMENSIONAL CONCEPT

D3D is an automated system based on footscan® measurements and calculations that provides a proposal for insoles with a modular construction and external added corrections. D3D insoles exist for a whole range of people, from diabetics to top athletes, and can be used for daily life as well as for (intensive) sports activities, both preventive as curative.

Die Basis-Einlagen, Decksohlen und Korrektur-elemente können zu einer perfekten Einlage für den Benutzer und dessen Aktivitäten kombiniert werden.

Combineer de basiszolen, bovenzolen en correctie-elementen om een perfecte steunzool te maken, aangepast aan de activiteiten van de gebruiker.

Combinez les supports de base, les semelles de recouvrement et les corrections pour créer une semelle orthopédique parfaitement adaptée aux activités du client.

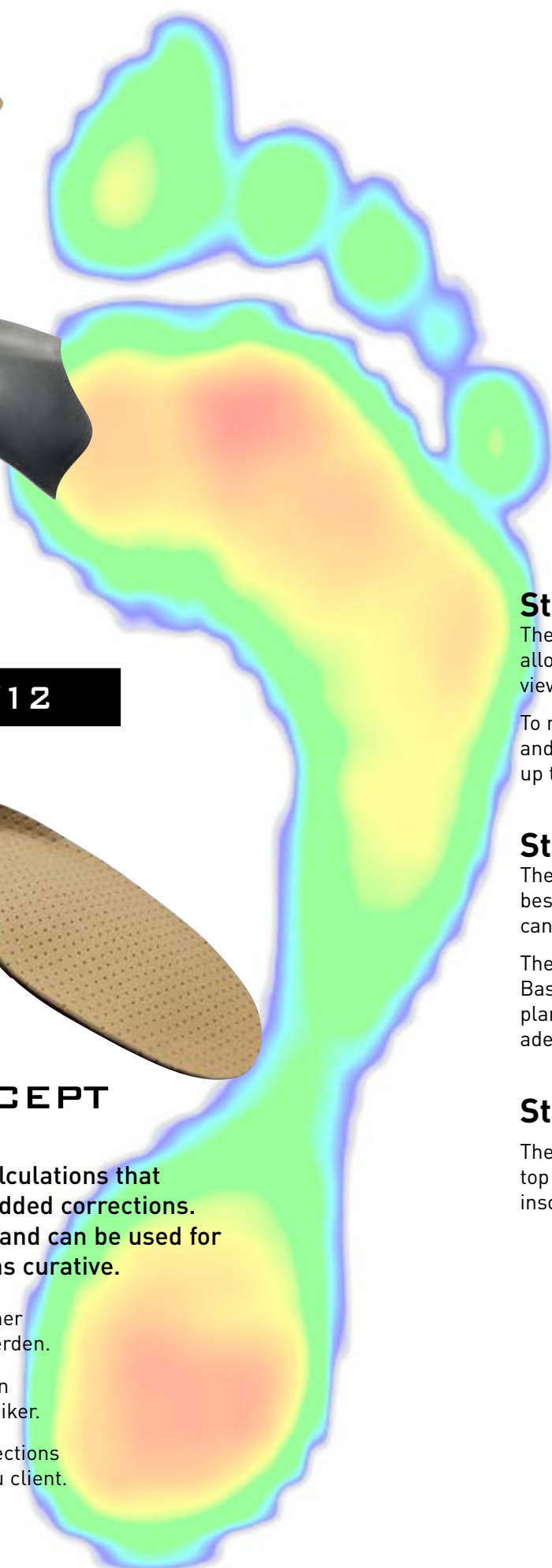

Step 1: footscan® pressure measurement

The high recording speed of the footscan systems, up to 500 frames of data per second, allows a highly accurate analysis of the pressure distribution. This will give you a clear view on the movement of the foot and its mechanics.

To meet the demands of different users, Rsscan International developed several software and hardware packages. Hardware packages available from entry level/0,5m plate/300Hz up to hi-end level 500Hz/3D interface box/2m plate.

Step 2: orthotic proposal via footscan software

The footscan software decides which different modules to combine in order to obtain the best fitting D3D orthotics. The composition made by the software is only a proposition and can be altered by the user based upon his own experience.

The D3D concept is build-in in the footscan® Gait Software package (available levels: Basic, Clinical & Scientific), which is specially developed to analyze the static and dynamic plantar foot pressures. This software also offers a lot of graphs and figures to make an adequate diagnosis. It is available on all footscan® pressure plate systems.

Step 3: fabrication of the footscan® orthotics (insole)

The different modules are molded out of the best EVA material. The various basic inlays, top layers and correction elements can be combined, glued and scoured to make a perfect insole for the customers' activity requirements.

The footscan® D3D orthotics can predict and reduce lower limb injuries.
 A study of the Britannia Royal Naval College (Dartmouth, UK) concludes that injury rate of military professionals can be predicted and reduced with the RSscan footscan® D3D-system. This was the first and largest randomised controlled study ever undertaken worldwide to compare orthotic use with injury reduction. A reduced injury rate of 31% was found!
 Reference:Foot Orthoses in the Prevention of Injury in Initial Military Training - A Randomized Controlled Trial
 Andrew Franklyn-Miller, MBBS, Cassie Wilson,z PhD - James Bilzon,z PhD, and Paul McCrory,y PhD

1 TOP COVER - DECKSOHLE - BOVENZOO - SEMELLE DE RECouvreMENT

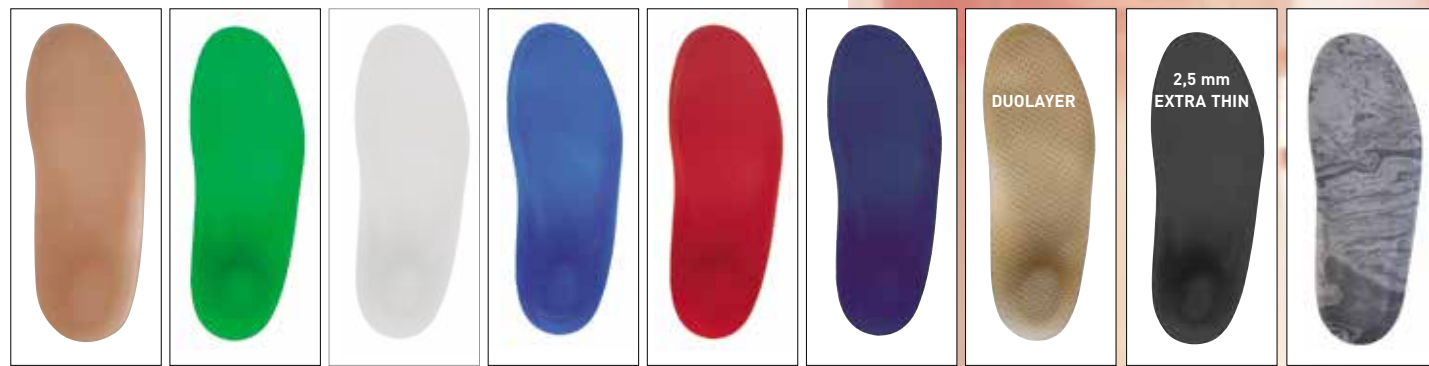

7801.121 Termolast skin colour Sh. 20A - 40C 5mm diabetic/comfort UK sizes 1-13	7801.017 Extrafoam green Sh. 25A - 45C 5mm diabetic/comfort UK sizes 1-13	7801.010 Extrafoam light grey Sh. 25A - 45C 5mm comfort UK sizes 4-15	7801.028 Extrafoam blue Sh. 35A - 55C 5mm comfort/sport/ ←70kg UK sizes 1-15	7801.039 Extrafoam red Sh.50A - 70C 5mm high perform./ →70kg UK sizes 1-15	7801.035 Extrafoam dark blue Sh. 50A - 70C 3,5mm high perform./ →70kg UK sizes 1-15	7801.051 Hardair + Termolast Perfo black + beige Sh. 60A + sh.30A 5mm diabetic/stability UK sizes 2-15	7801.070 Hardair black Sh. 60A - 80C 2,5mm extra thin sport/high perform. UK sizes 2-15	7801.060 EVA marble black Sh.30 5mm comfort/sport UK sizes 1-13
--	--	--	--	--	---	--	--	--

2 BASIC INLAY - BASIS EINLAGE - BASISZOO - SUPPORT DE BASE

D3D ORTHOPAEDIC INSOLES

→ examples page 3.20



7803.221F Termolast skin colour Shore 30A - 45C diabetic/comfort UK sizes 1-15	7803.028N 7803.028F Extrafoam blue Shore 35A - 55C comfort/sport/←70kg UK sizes 1-15	7803.040N 7803.040F Softair black Shore 45A - 65C comfort/high performance UK sizes 1-15	7803.036N 7803.036F Extrafoam white Shore 50A - 70C high performance/→70kg UK sizes 1-15	7803.100N 7803.100F It-Air Cork cork Shore 60A - 80C very high perform./heavy persons UK sizes 1-15
--	--	--	--	---

D3D TWENTY12 BLACK

→ examples page 3.21

N = high arch, hohes Fuß-Gewölbe, hoog gewelf, voûte prononcée
F = low arch, tiefes Fuß-Gewölbe, laag gewelf, voûte basse

NOTE:
shoe size equals top cover size. Always order top cover size.
shell size = -1 size.

7803.500N
7803.500F
black polypropylen shell
ultra thin, ultra stable, ultra fit
UK sizes 2-13



SIZES - GRÖSSEN - MATEN - POINTURES



Also deliverable in very big sizes

3 CORRECTION - KORREKTURELEMENT - CORRECTIE - ÉLÉMENT DE CORRECTION

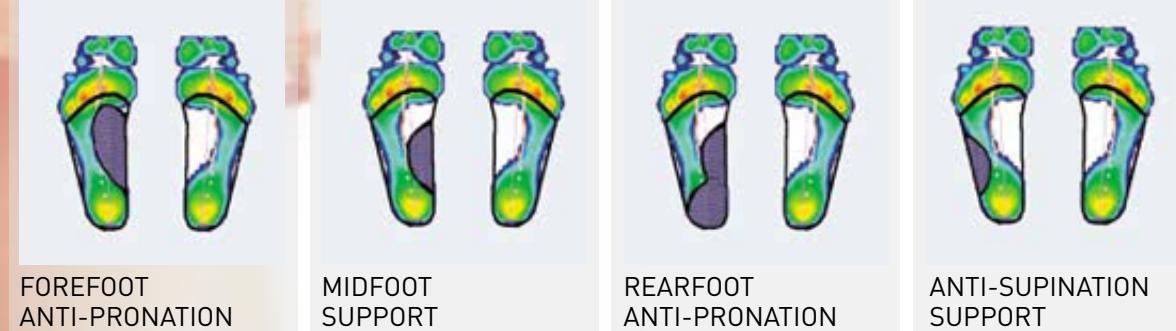

CURVED - GEBOGENE - GEBOGEN - COURBÉ

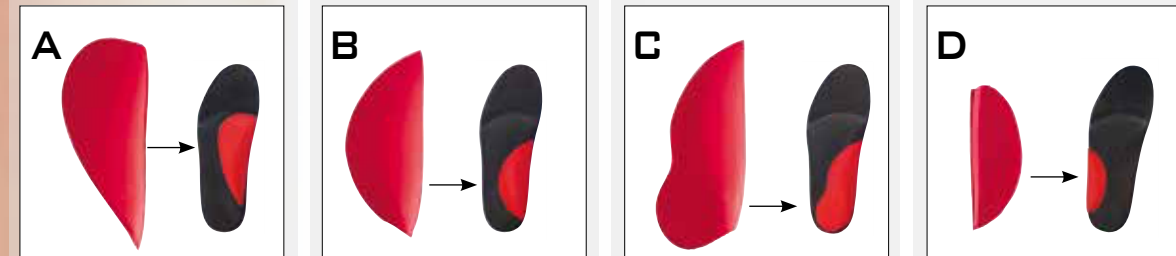

7806.039.A **7806.039.B** **7806.039.C** **7806.039.D**

Extrafoam, red
Shore 50A - 70C

FLAT - FLACH - VLAK - PLAT

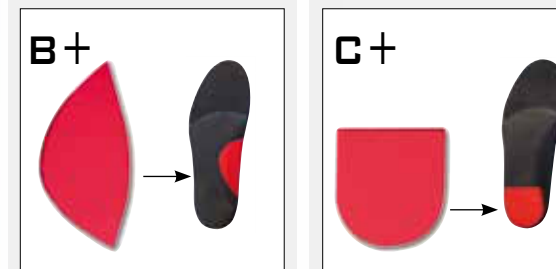

7830.2902.B [136p]
7830.2904.B [136p]
7832.2902.B
7832.2904.B

7830.3902.C [94p]
7830.3904.C [94p]
7832.3902.C
7832.3904.C

Extrafoam, red
2mm, Shore 35A - 55C
4mm, Shore 50A - 70C
2mm, Shore 35A - 55C
4mm, Shore 50A - 70C

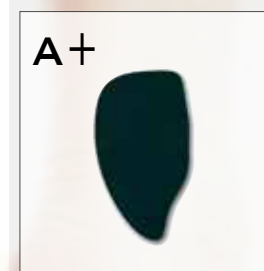

7830.6002.A [110p]
7832.6002.A

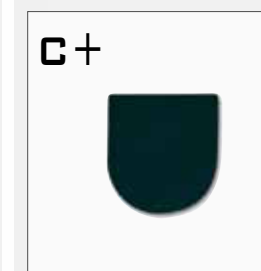

7830.6002.C [138p]
7830.6004.C [141p]
7832.6002.C
7832.6004.C

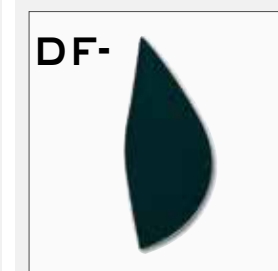

7830.6002.DF [114p]
7832.6002.DF

Noène, black
2mm
4mm
2mm
4mm



01 01/02	03 03/04	05 05/06	07 07/08/09	10 10/11	12 12/13/14
-------------	-------------	-------------	----------------	-------------	----------------



PER 5 PAIRS
CUT AND PACKED PER SHEET (quantity/pack)
CUT AND PACKED PER 10 PAIRS



Beispiele - examples - voorbeelden - exemples

D3D ORTHOPAEDIC INSOLES



SPORT
75 D3 232 N/F
Cover: Extrafoam grey
Base: Extrafoam white
Shore: 50



SPORT
75 D3 102 N/F
Cover: Extrafoam royal blue
Base: Extrafoam blue
Shore: 35



KIDS
75D3-701FR
75D3-701NR



SPORT
75 D3 203 N/F
Cover: Extrafoam red
Base: Extrafoam white
Shore: 50



KIDS
75P13240
Half sole
Kurzsohlig
Halfzool
Semelle courte



SPORT
75 D3 204 N/F
Cover: Extrafoam dark blue
Base: Extrafoam white
Shore: 50



KIDS
75P11240
Full sole
Langsohlig
Langzoolig
Semelle entière



DUO LAYER • DIABET
75 D3 409 N/F
Cover: Hardair + Termolast Perf
Base: Softair
Shore: 45A - 65C

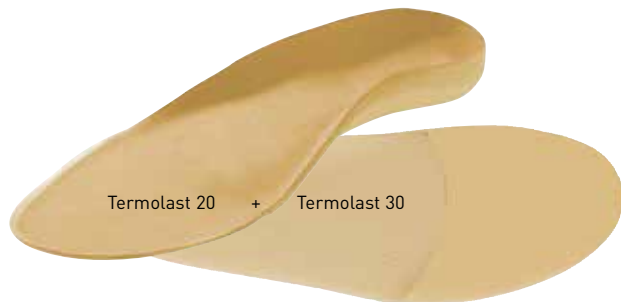

DIABET
75 D3 307 N/F
Cover: Termolast 20
Base: Termolast 30
Shore: 30

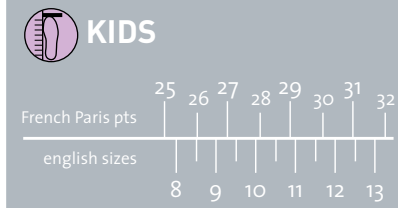

Colouredifferences between print and original product are possible.
Farbabweichungen zwischen dem Farbdruk und dem Originalprodukt sind möglich.
Kleurverschillen tussen het drukwerk en het origineel product zijn mogelijk.
Des différences de couleur entre l'imprimerie et le produit originale sont possible.

Beispiele - examples - voorbeelden - exemples

D3D TWENTY12 INSOLES



75 D3B 021 N/F
Cover: Termolast
Base: 'Black'
Shore: 20



75 D3B 060 N/F
Cover: EVA marble black
Base: 'Black'
Shore: 30



75 D3B 017 N/F
Cover: Extrafoam green
Base: 'Black'
Shore: 25



75 D3B 010 N/F
Cover: Extrafoam grey
Base: 'Black'
Shore: 25

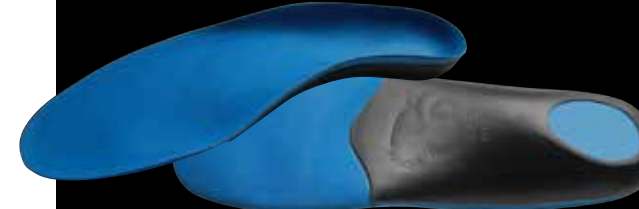

75 D3B 028 N/F
Cover: Extrafoam blue
Base: 'Black'
Shore: 35



75 D3B 039 N/F
Cover: Extrafoam red
Base: 'Black'
Shore: 50

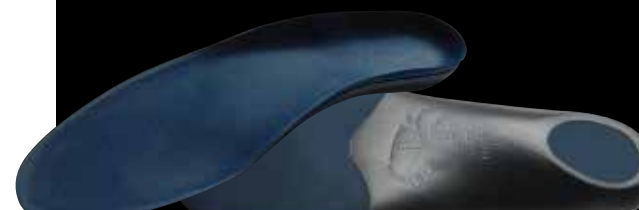

75 D3B 035 N/F
Cover: Extrafoam dark blue
Base: 'Black'
Shore: 50



75 D3B 051 N/F
Cover: Duolayer
Base: 'Black'



75 D3B 070 N/F
Cover: Hardair black
Base: 'Black'
Shore: 60



D3D SLIM ELEGANT INSOLES

Insoles based on the D3D lasts, perfectly suited for fine classic shoes.
 Einlagen basierend auf den D3D Leisten, ideal für klassische, feine Schuhe.
 Steunzolen gebaseerd op de D3D-leesten, perfect in fijne klassieke schoenen.
 Semelles à base des formes D3D, parfait pour des chaussures classiques.



Intermediate layer:
EXTRA Elegant (hard plastic)

N = high arch, hohes Fuß-Gewölbe, hoog gewelf, voûte prononcée
F = low arch, tiefes Fuß-Gewölbe, laag gewelf, voûte basse



SLIM LEATHER - STYLE
75L11ND1
75L11FD1
 4/4 full sole in leather
 + EXTRA Elegant
 + 1/2 Suetex, middle brown



SLIM EVA - STIFF
75L26ND1
75L26FD1
 4/4 Hardair 2 mm, dark blue
 + EXTRA Elegant
 + 1/2 Hardair 1,5 mm, dark blue



SLIM SKAI - SMOOTH
75L28ND1
75L28FD1
 4/4 Skai
 + EXTRA Elegant
 + Softair

sizes 35-40 Ladies
 sizes 41-47 Gentlemen

ZWISCHENSCHICHT - INTERMEDIATE LAYER - TUSSENBOUW - INTERCALAIRE

EXTRA ELEGANT

		7522.401	7522.402
		weiß, hart white, hard wit, hard blanc, dur	beige, weich beige, soft beige, soepel beige, souple
35	35/36	•	•
37	37/38	•	•
39	39/40	•	•
41	41/42	•	•
43	43/44	•	•
45	45/46	•	•
47	47/48	•	•



BASIC SHELL LARGE

		7522.301
		+ Pelot + pads + pelot + pelotte
35	35	•
bis to t/m à	bis to t/m à	
46	46	



Stellen Sie Ihre eigenen **Sport** Einlagen zusammen.
You can combine your own **Sport** inlays.
U kunt zelf uw **Sport** steunzool samenstellen.
Combinez vous-même votre semelle orthopédique **Sport**

A DECKSOHLEN - COVER - BOVENBOUW - RECOUVREMENT: EXTRAFOAM

1 Wählen Sie Ihr Modell
Choose the model
Kies het model
Choisissez le modèle

	MEDIUM langsohlig full sole langzilig semelle entière		LARGE langsohlig breit full sole large langzilig breed semelle entière large
--	--	--	---

2 Wählen Sie das material/die Härte
Choose the material/hardness
Kies het materiaal/de hardheid
Choisissez le matériel/la dureté

→ page 1.12-1.15

3 Wählen Sie Ihre Farbe
Choose the colour
Kies de kleur
Choisissez la couleur

EXTRAFOAM, MULTICOLOUR, AQUA/MARBLE

06	01	04	08	05	07	09	10	17	00
11	12	14	15	16	18	19			
30	31	32	33	35	36	37	38	48	

4 Wählen Sie die Stärke
Choose the thickness
Kies de dikte
Choisissez l'épaisseur

	3 3mm	4 4mm standard
--	-----------------	-----------------------------

5 Wählen Sie die Ausführung
Choose the finish
Kies de afwerking
Choisissez la finition

	0 nicht perforiert not perforated niet geperforeerd non perforé	5 perforiert perforated geperforeerd perforé
--	--	---

Farbabweichungen zwischen dem Farbdruck und dem Originalprodukt sind möglich.
Colour differences between print and original product are possible.
Kleurverschillen tussen het drukwerk en het origineel product zijn mogelijk.
Des différences de couleur entre l'imprimerie et la produit originale sont possible.

B ZWISCHENSCHICHT - INTERMEDIATE LAYER - TUSSENBOUW - INTERCALAIRE

6 Versteifung
Stiffening tissue
Verstijvingsstof
Renforcement

	mit with met avec		ohne without zonder sans
--	-----------------------------------	--	--

7 Wählen Sie die Pelotte
Choose the pad
Kies de pelot
Choisissez le pelotte

	mit eingedrückte Pelotte with impressed pad met perspelot avec pelotte incorporée		mit gummi Pelotte with gummi pad met gummipelot avec pelotte gummi	ohne without zonder sans
--	---	--	--	--

8 Wählen Sie das Model und die Bauweise
Choose the model and the construction
Kies het model en de constructie
Choisissez le model et la construction

	geöffnet open open ouvert		geschlossen closed dicht fermé
--	---	--	--

C GRUNDLAGE - BASE - BASIS - BASE: EXTRAFOAM

9 Wählen Sie das material/die Härte
Choose the material/hardness
Kies het materiaal/de hardheid
Choisissez le matériel/la dureté

→ page 1.12-1.15

10 Wählen Sie die Stärke
Choose the thickness
Kies de dikte
Choisissez l'épaisseur

11 Wählen Sie Ihre Farbe oder Ihr gewünschte Farbkombination
Choose the colour or a colour combination
Kies de kleur of een kleurcombinatie
Choisissez la couleur ou une combinaison de couleurs

Varia Standard

Varia geschliffen
Varia levelled
Varia geschuurd
Varia égalisé

examples - Beispielen - voorbeelden - exemples →



SPORT
NON PERFO 75ED1001



SPORT
PERFO 75FD1011



SPORT
PERFO OPEN 75FA3002



SPORT
75ED1019
Langsohlig medium
Full sole medium
Langzilig medium
Semelle entière medium



SPORT
75FE1009
Langsohlig breit
Full sole large
Langzilig breed
Semelle entière large



SPORT
75FD1036Z
Medium flach geschliffen
Medium levelled
Medium vlak geschuurd
Medium égalisé



75VD1001
Varia Standard



75VD1006Z
Varia geschliffen
Varia levelled
Varia geschuurd
Varia égalisé



KIDS 75FD3002



KIDS 75D3701FR
75D3701NR

KIDS 75P13240
Kurzsohlig
Half sole
Halfzool
Semelle courte





KIDS 75P11245
Basis It-Air-Kork
It-Air-Cork Basis
Basis It-air-kurk
Base Liège It-air



KIDS 75P11240
Langsohlig
Full sole
Langzilig
Semelle entière

A DECKSOHLEN - COVER - BOVENBOUW - RECOUVREMENT

1 Wählen Sie Ihr Modell
Choose the model
Kies het model
Choisissez le modèle

	ELEGANT langsohlig full sole langzilig semelle entière		MEDIUM langsohlig medium A full sole medium A langzilig medium A semelle entière medium A
---	---	---	--

2 Wählen Sie die Decksohle
Choose the covering
Kies de bekleding
Choisissez le revêtement

 → part 1
→ part 5

3 Wählen Sie die Ausführung
Choose the finish
Kies de afwerking
Choisissez la finition

	0 nicht perforiert not perforated niet geperforeerd non perforé	5 perforiert perforated geperforeerd perforé
---	--	---

B ZWISCHENSCHICHT - INTERMEDIATE LAYER - TUSSENBOUW - INTERCALAIRE

4 Wählen Sie die Größe
Choose the size
Kies de maat
Choisissez la pointure

**EXTRA ELEGANT
7522.401**

weiß, hart
white, hard
wit, hard
blanc, dur

 → page 3.23

	35 35/36	→	47 47/48
---	--------------------	---	--------------------

5 Wählen Sie die Pelotte
Choose the pad
Kies de pelot
Choisissez le pelotte

		mit gummi Pelotte with gummi pad met gummipelot avec pelotte gummi	ohne without zonder sans
---	---	---	-----------------------------------

6 Wählen Sie das Pelotte-Modell und -Bauweise
Choose the pad model and -construction
Kies het pelotmodel en -constructie
Choisissez le model et la construction de la pelotte

	geöffnet open open ouvert	geschlossen closed dicht fermé
---	------------------------------------	---

C GRUNDLAGE - BASE - BASIS - BASE

7 Wählen Sie Ihr Modell
Choose the model
Kies het model
Choisissez le modèle

	4/4 langsohlig full sole langzilig semelle entière	3/4 kurzsohlig half sole kortzilig semelle courte
---	---	--

9 Wählen Sie das Material/die Härte
Choose the material/hardness
Kies het materiaal/de hardheid
Choisissez le matériel/la dureté

 → part 1
→ part 5

10 Wählen Sie die Stärke
Choose the thickness
Kies de dikte
Choisissez l'épaisseur

11 Wählen Sie Ihre Farbe
Choose the colour
Kies de kleur
Choisissez la couleur



Beispiele - exemples - voorbeelden - exemples

A DECKSOHLEN - COVER - BOVENBOUW - RECOUVREMENT: WALKCROUPON

mit Walkledercroupon bezogen
covered with Walkcroupon
bekleed met walkcroupon
revêtues de croupon à mouler

Wählen Sie Ihr Modell
Choose the model
Kies het model
Choisissez le modèle

	MEDIUM		LARGE
	langsohlig full sole langzolic semelle entière		langsohlig breit full sole large langzolic breed semelle entière large

B ZWISCHENSCHICHT - INTERMEDIATE LAYER - TUSSENBOUW - INTERCALAIRE

nicht verfügbar / not applicable / niet van toepassing / non applicable

C GRUNDLAGE - BASE - BASIS - BASE: CORK

Wählen Sie das Material und die Größe
Choose the material and size
Kies het materiaal en de maat
Choisissez le matériel et la pointure

	7522.201	7522.201V
	Naturkork natural cork natuurkurk liège naturel	Naturkork + Versteiffung natural cork + stiffening natuurkurk + verstijving liège naturel + renforcement
23 bis to t/m à 47	23/24 bis to t/m à 47/48	

75K12020
4/4 medium Oberbau
4/4 medium upper
4/4 medium bovenbouw
4/4 medium recouvrement

75K12030
4/4 breit
4/4 large
4/4 breed
4/4 large

75K22080
breit mit Versteiffung
large with stiffening tissue
breed met verstijving
large avec toile thermocollante

75K1308
4/4 medium mit Tropfenform Pelotte
4/4 medium with drop pad
4/4 medium met druppel pelot
4/4 medium avec goutte talonette

Beispiele - examples - voorbeelden - exemples

A DECKSOHLEN - COVER - BOVENBOUW - RECOUVREMENT: CORK

latex kork Decksohle
latex cork cover
latex kurk bovenbouw
recouvrement en liège mousse

Wählen Sie Ihr Modell
Choose the model
Kies het model
Choisissez le modèle

	7522.001	7522.002
	Latex Kork latex cork moussekurk liège mousse	Latex Kork mit Pelotte latex cork with pad moussekurk met pelot Liège mousse avec pelotte
	kein Gewölbe no vault geen gewelf sans voûte	35/36 → 45/46
A	hohes Gewölbe pronounced vault hoog gewelf voûte prononcée	36A → 42A
B	Standard-Gewölbe standard vault normaal gewelf voûte standard	24B → 46B

7520001A
hohes Gewölbe
pronounced vault
hoog gewelf
voûte prononcée

7520002
mit Pelotte
with pad
met pelot
avec pelottes

7520001B
Standard-Gewölbe
standard vault
normaal gewelf
voûte standard

7520010
geschliffen
levelled
geschuurd
égalisé

B ZWISCHENSCHICHT - INTERMEDIATE LAYER - TUSSENBOUW - INTERCALAIRE

nicht verfügbar / not applicable / niet van toepassing / non applicable

C GRUNDLAGE - BASE - BASIS - BASE: LEATHER

Spattleder / splitleather / rundscroûte / croûte de vachette

Beispiele - examples - voorbeelden - exemples

745061.

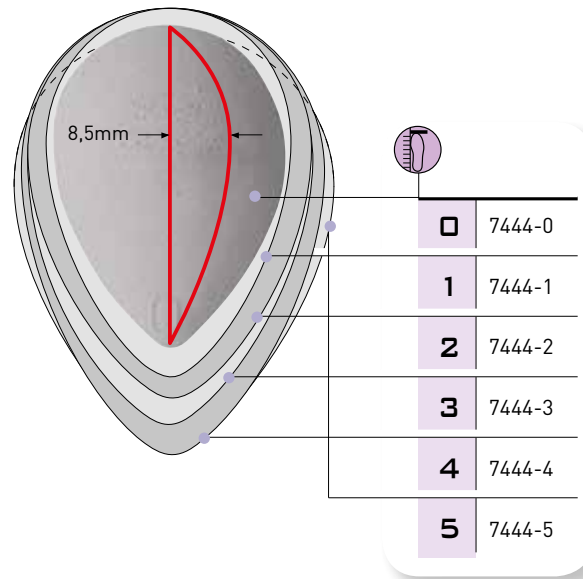

745301.

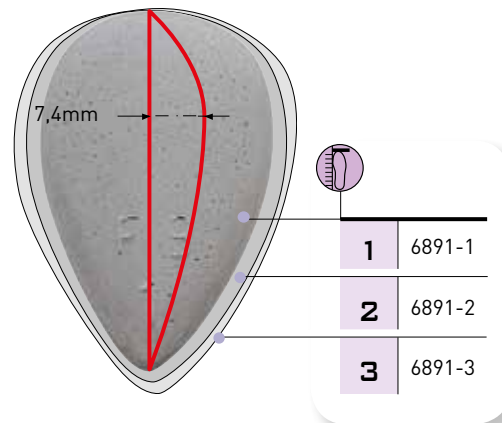

745331.

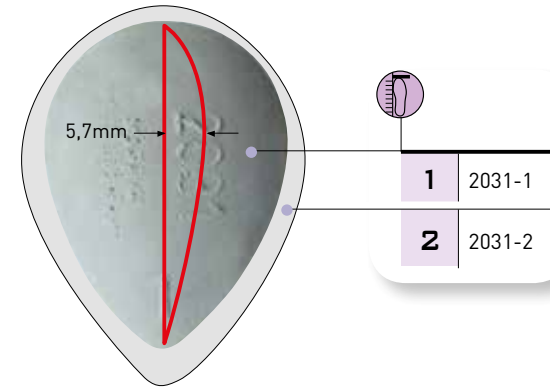

745341.

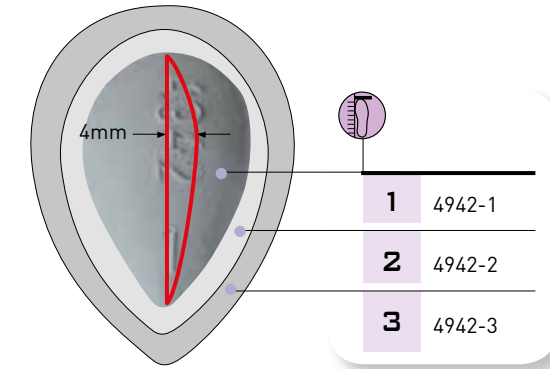

745370.

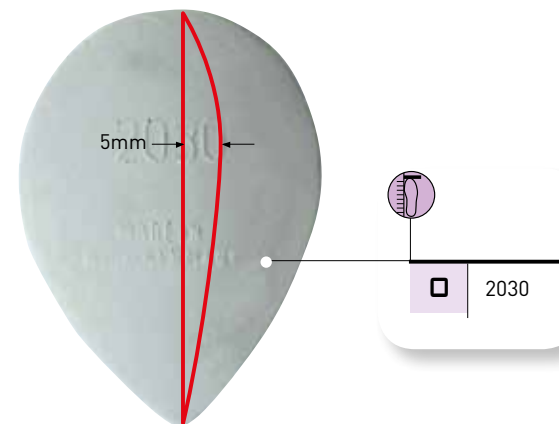

745228.

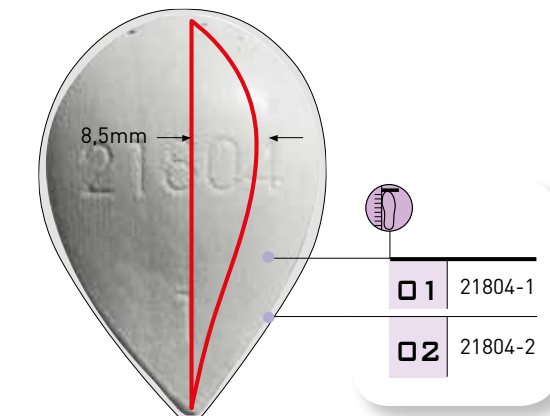

745091.

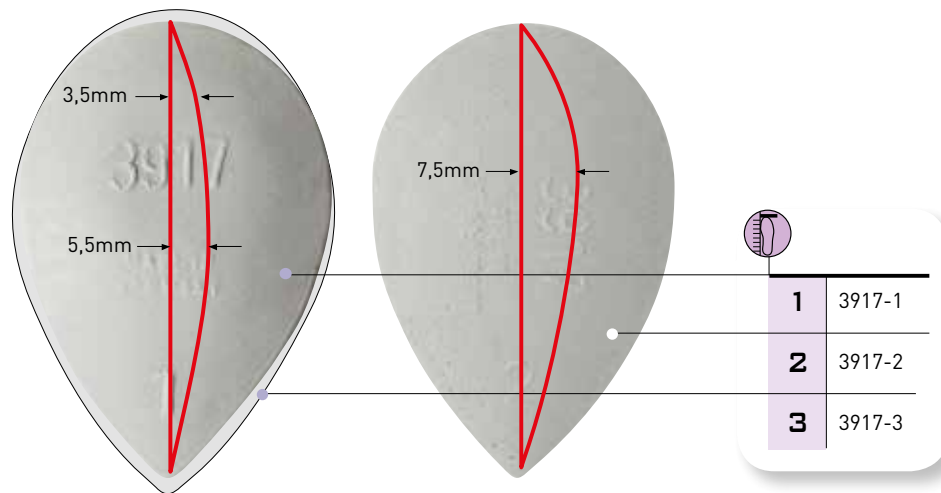

745151.

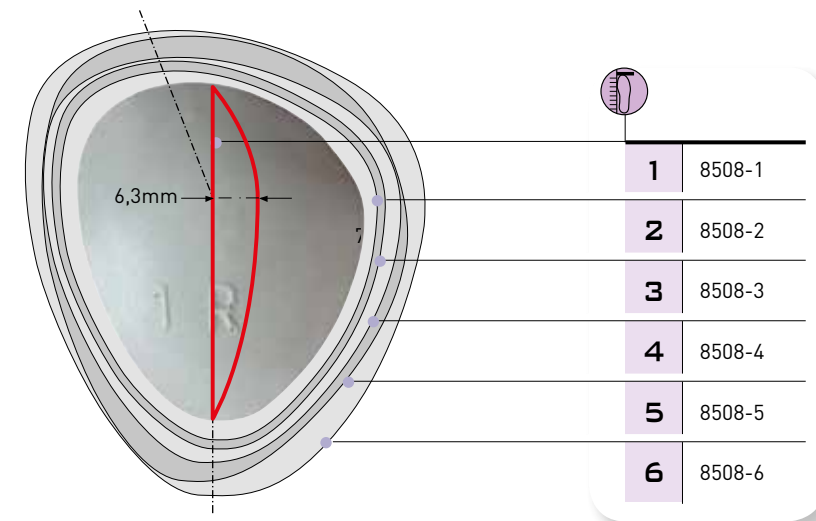

74504.

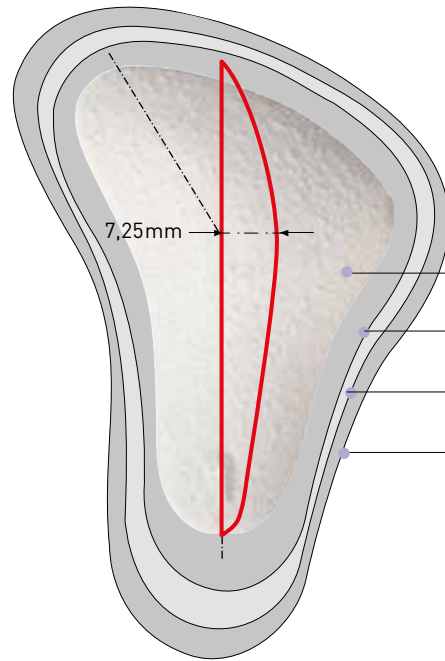

	1	3	4	5
	Latex latex latex	Gummi rosa rubber rosa rubber rosa caoutch. rosa	Gummi hart rubber hard rubber hard caoutch. dur	Gummi-Kork rubber cork rubberkurk liège caoutch.
1	7443-1	9020/060-1	9020/051-1	9020/015-1
2	7443-2	9020/060-2	9020/051-2	9020/015-2
3	7443-3	9020/060-3	9020/051-3	9020/015-3
4	7443-4	9020/060-4	9020/051-4	9020/015-4

745101.

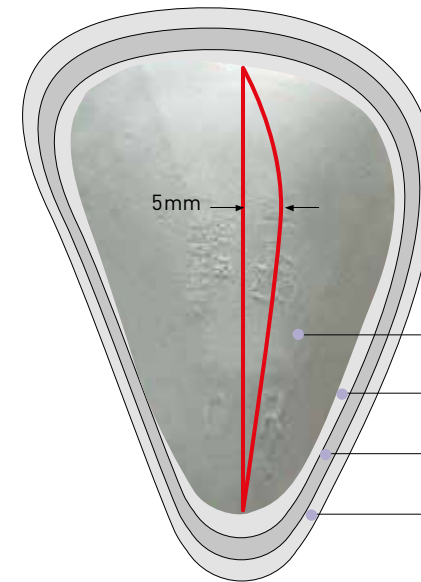

□	6648-0
1	6648-1
2	6648-2
3	6648-3

745131.



□	12419-6
06	12419-6
07	12419-7
08	12419-8
09	12419-9

745051.

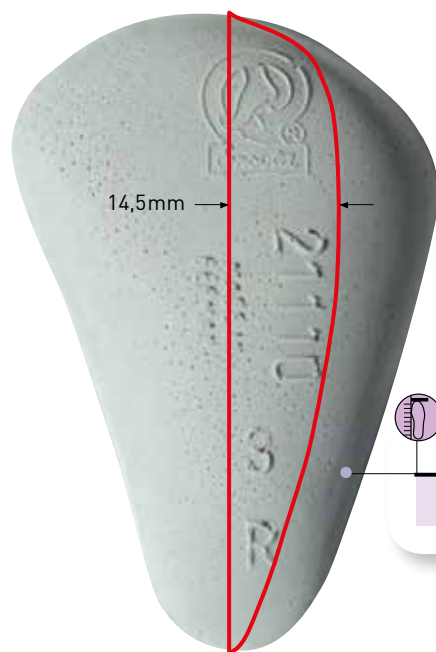

3	21110/000-3
---	-------------

745071.

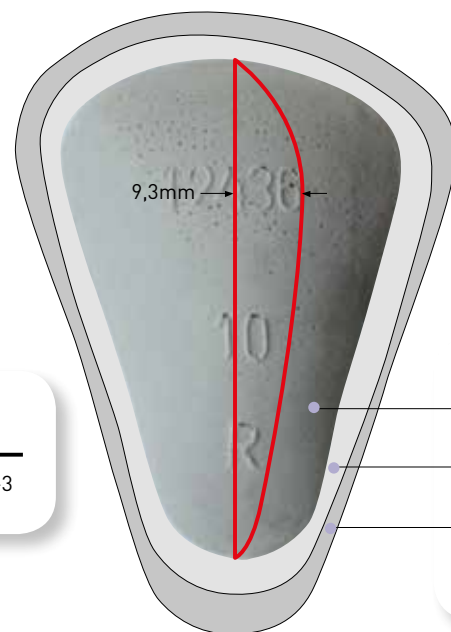

□	12436-10
11	12436-11
12	12436-12

745361.

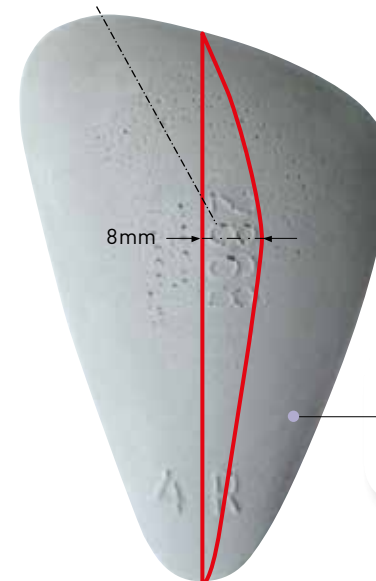

4	2868-4
---	--------

745191.

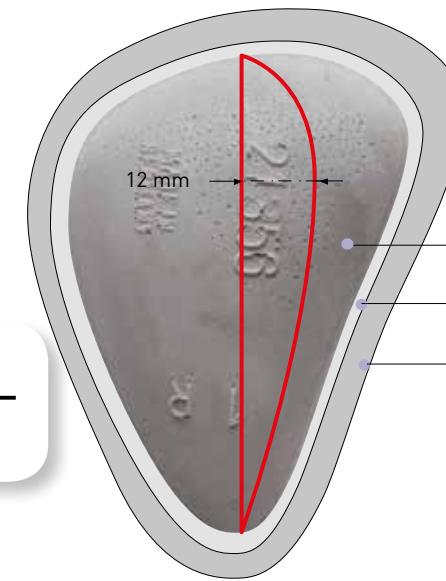

1	21356 -1
2	21356 -2
3	21356 -3

745081.

MAGENFORM - STOMACH SHAPED - MAAGVORM - MODÈLE ESTOMAC

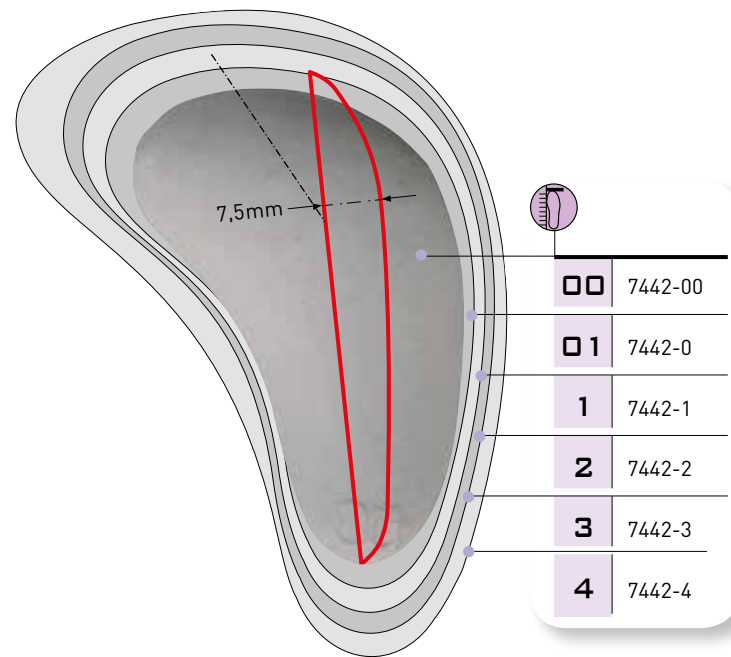

745261.

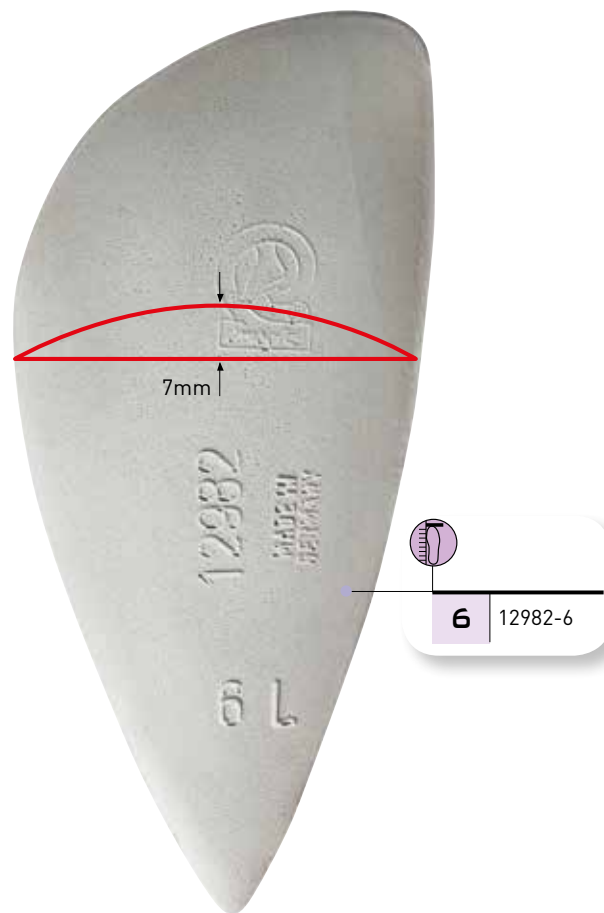

745291.

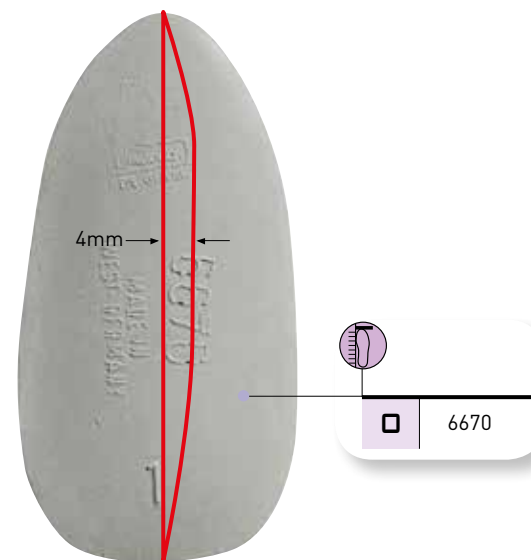

745281.

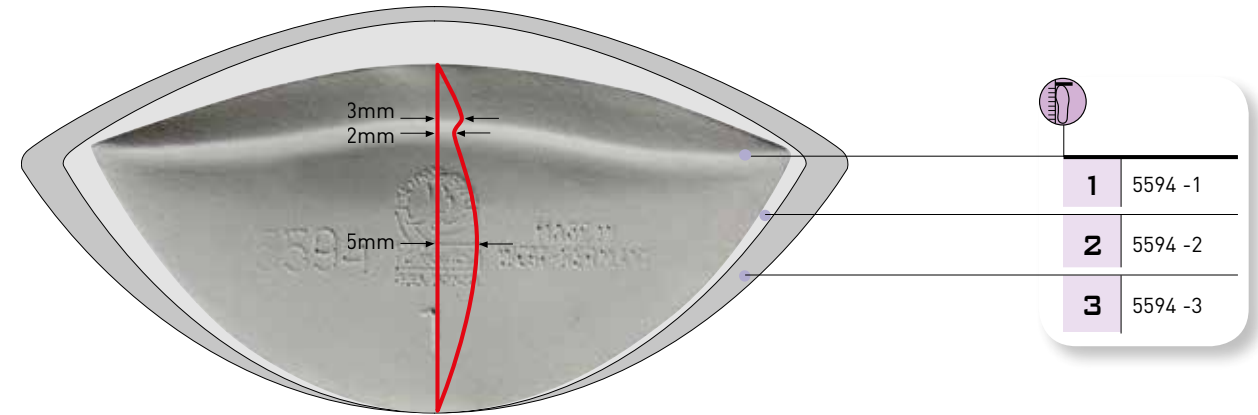

745111.

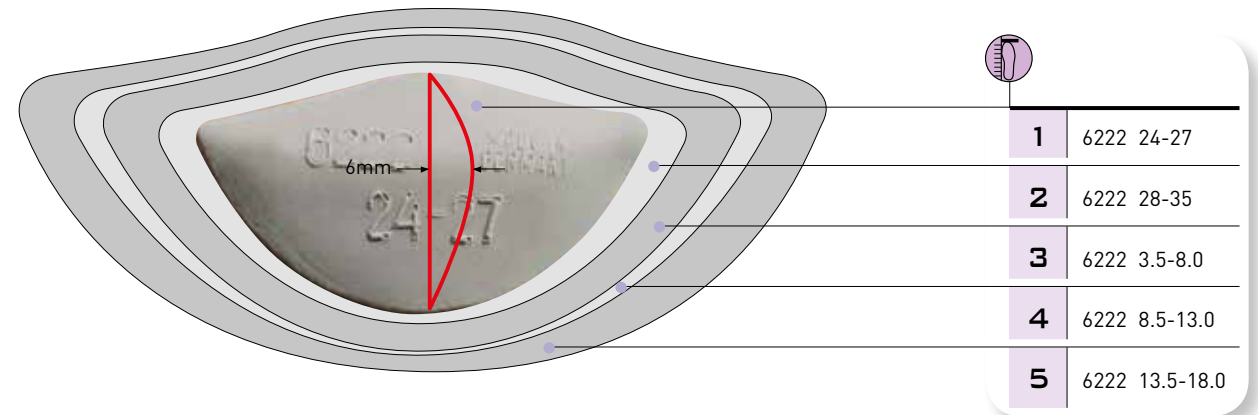

745171.

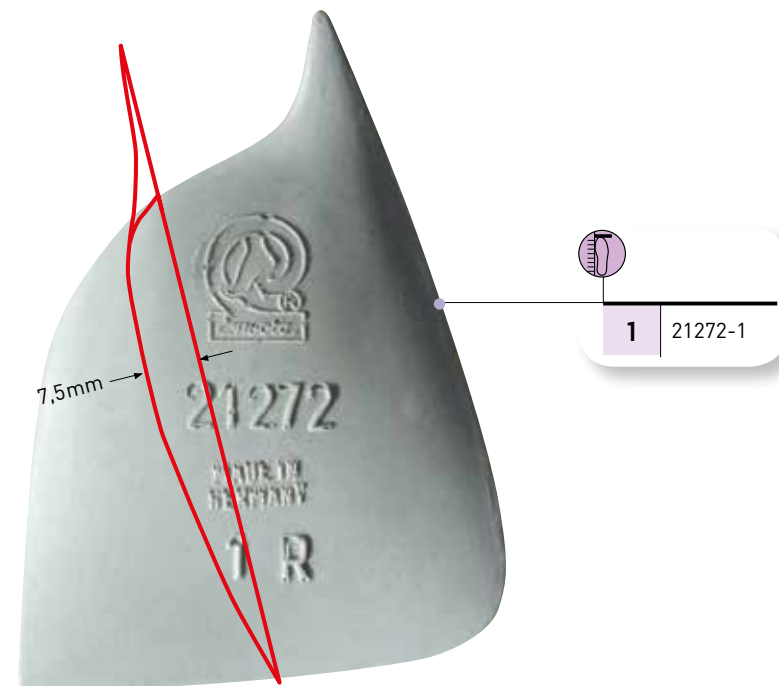

745201.

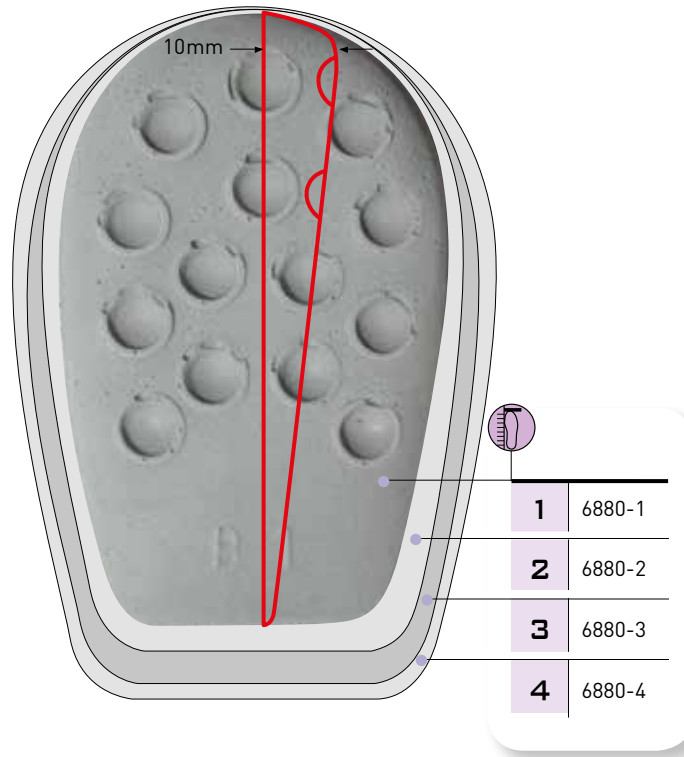

1	6880-1
2	6880-2
3	6880-3
4	6880-4

745221.

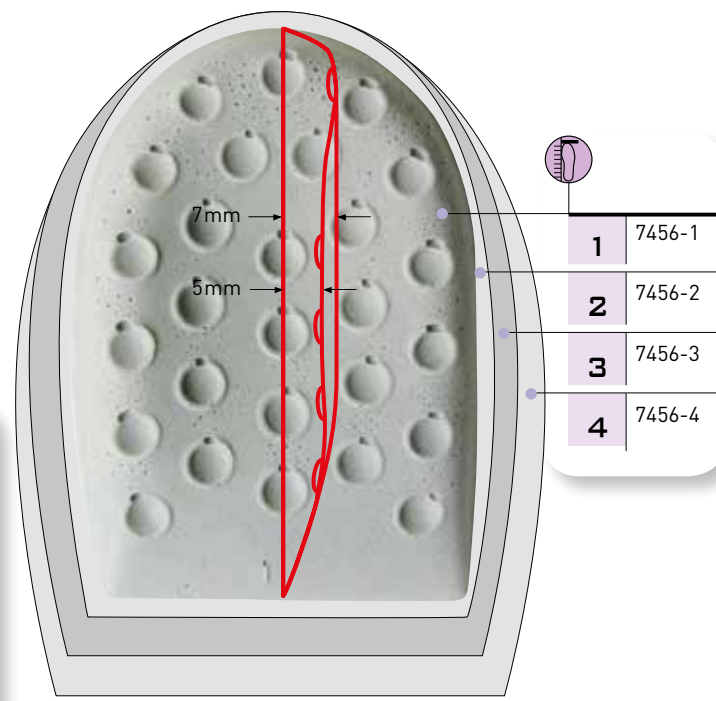

1	7456-1
2	7456-2
3	7456-3
4	7456-4

745211.

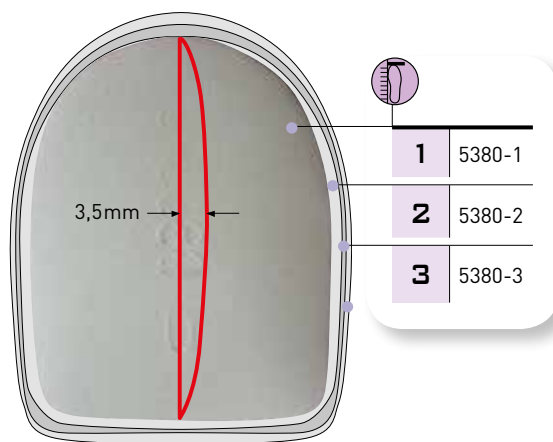

1	5380-1
2	5380-2
3	5380-3

745230.

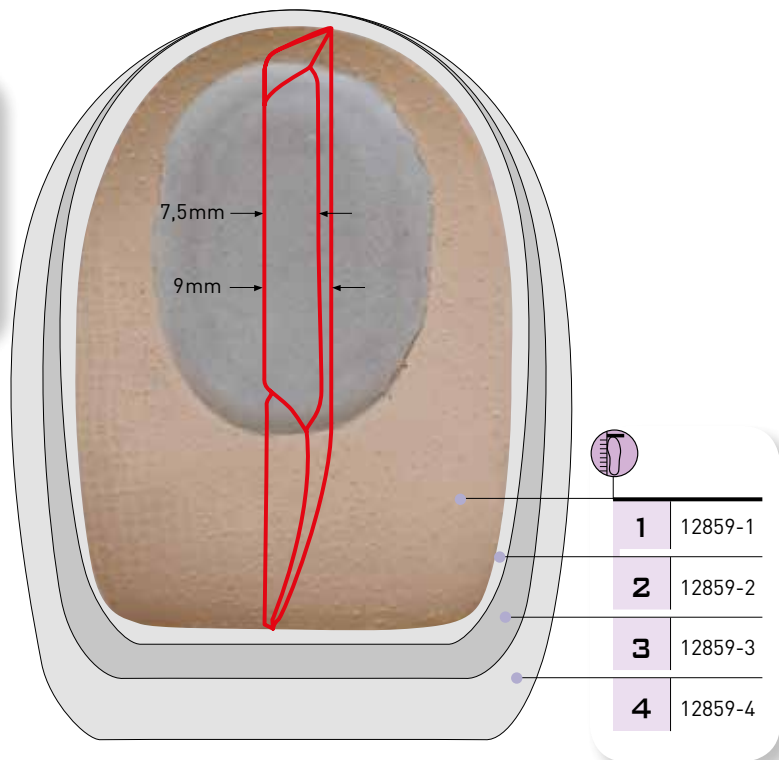

1	12859-1
2	12859-2
3	12859-3
4	12859-4

745141.

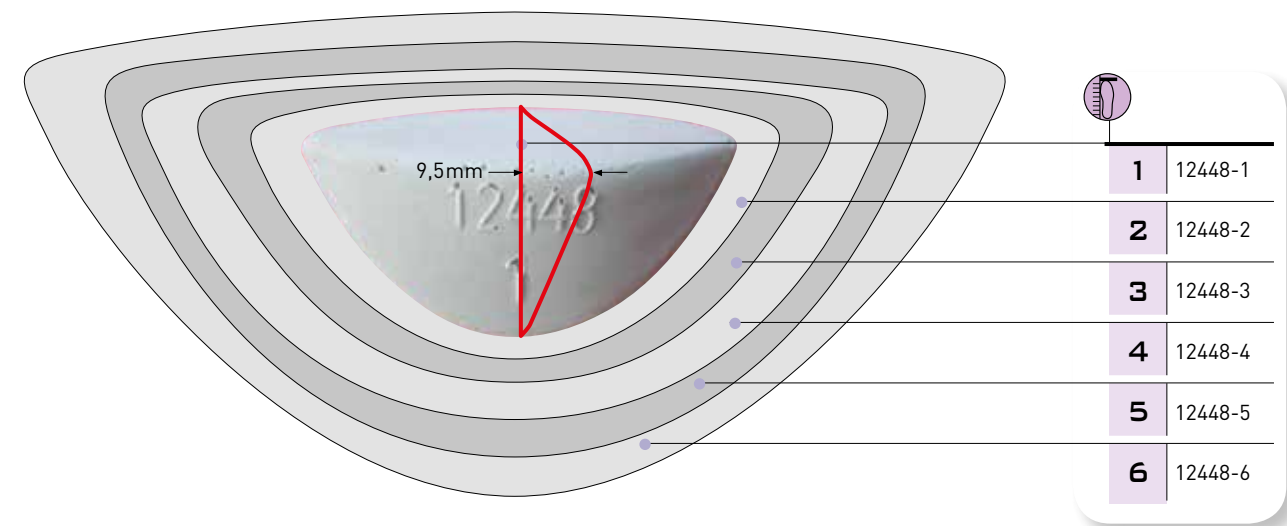

1	12448-1
2	12448-2
3	12448-3
4	12448-4
5	12448-5
6	12448-6

74516.

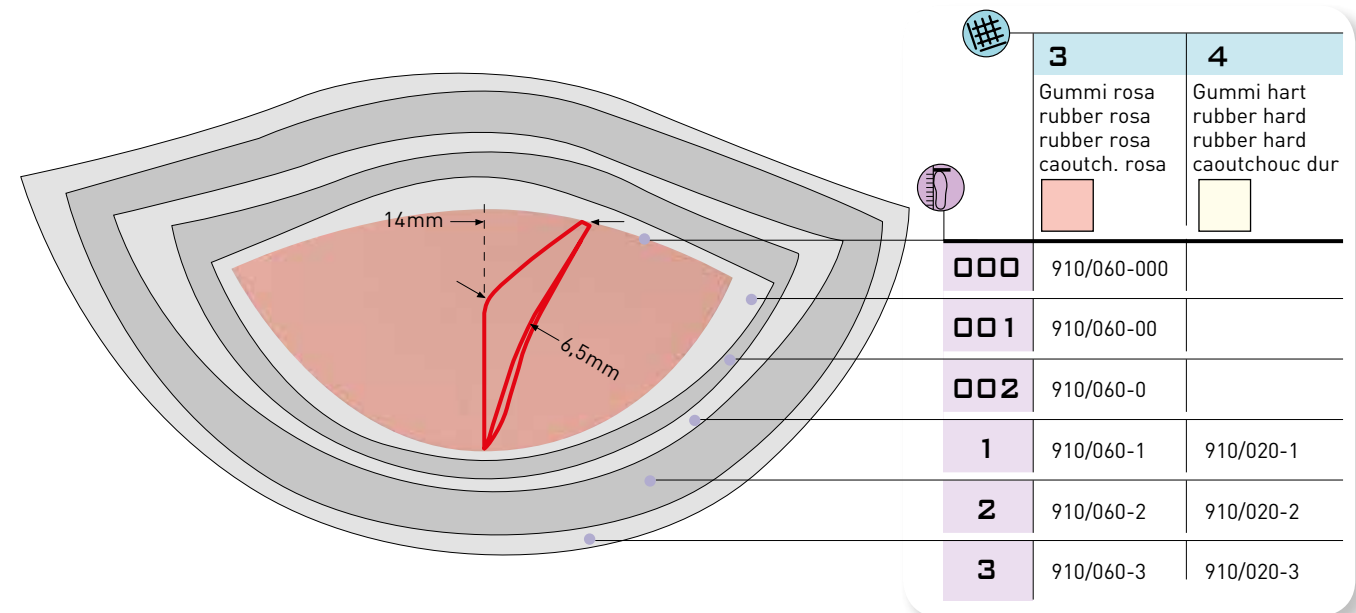

	3	4
	Gummi rosa rubber rosa rubber rosa cautch. rosa	Gummi hart rubber hard rubber hard caoutchouc dur
000	910/060-000	
001	910/060-00	
002	910/060-0	
1	910/060-1	910/020-1
2	910/060-2	910/020-2
3	910/060-3	910/020-3

745183.

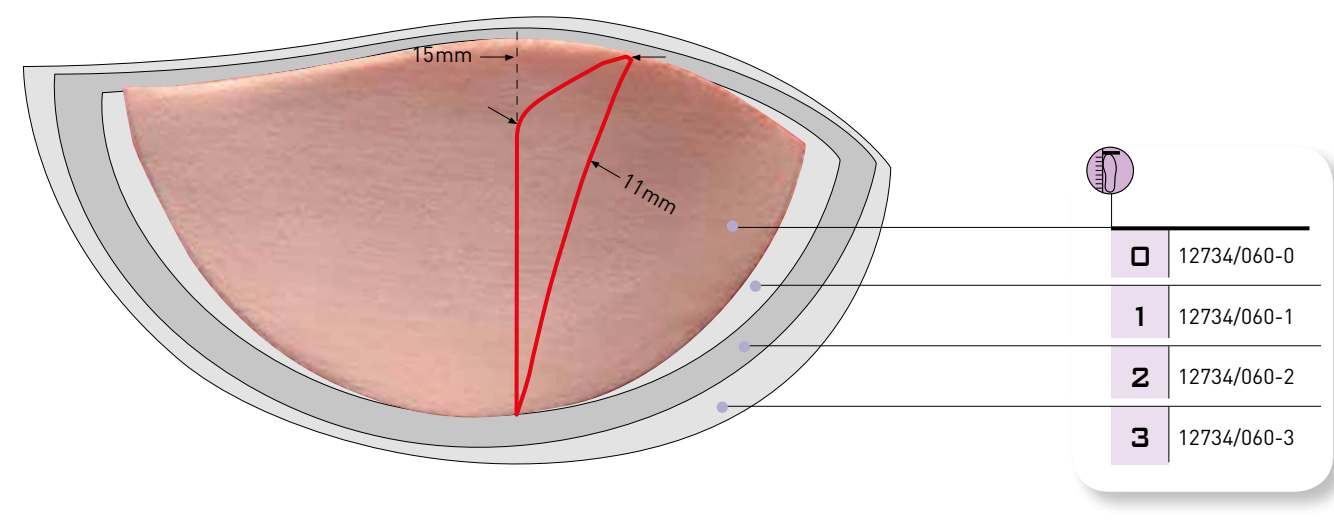

0	12734/060-0
1	12734/060-1
2	12734/060-2
3	12734/060-3

745001.

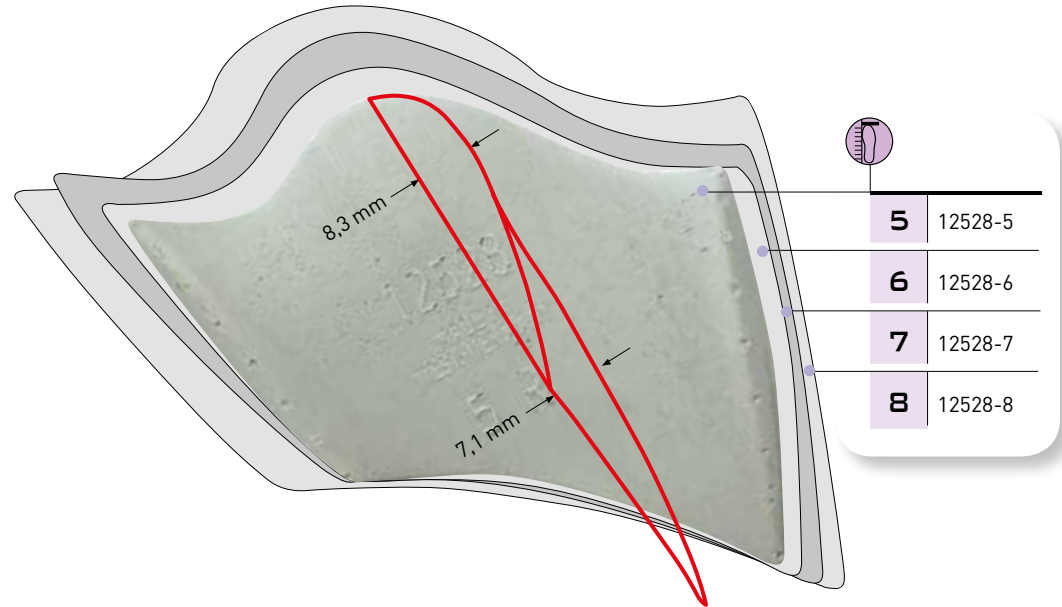

745011.



745021.

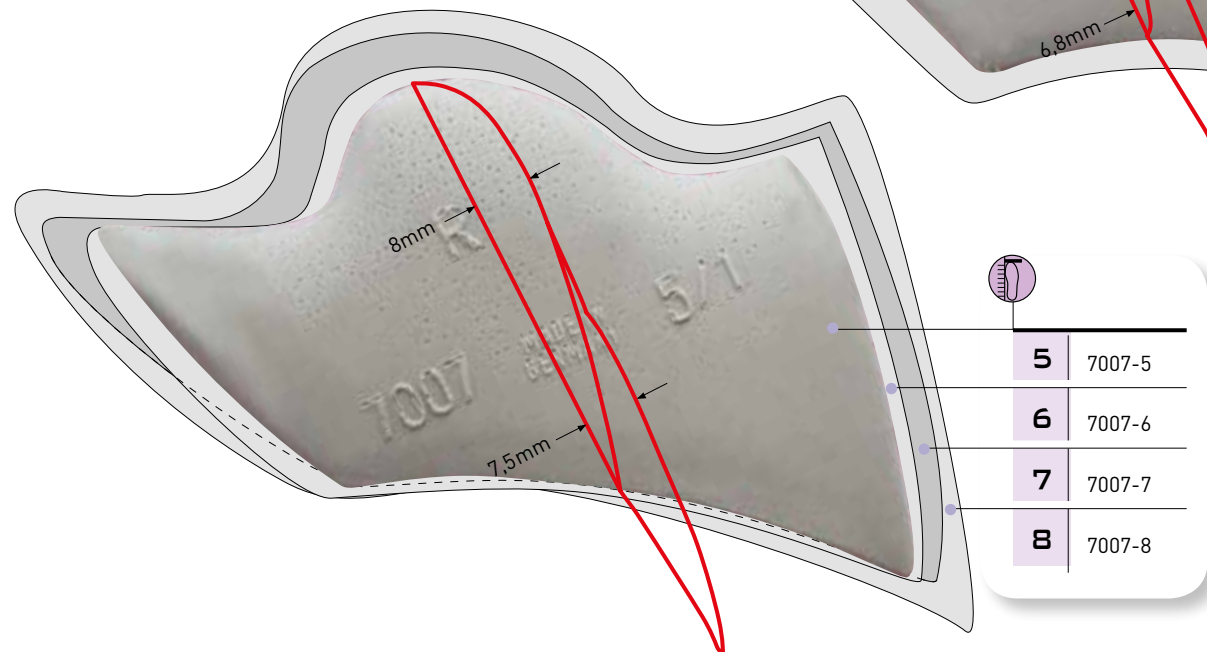

745271.

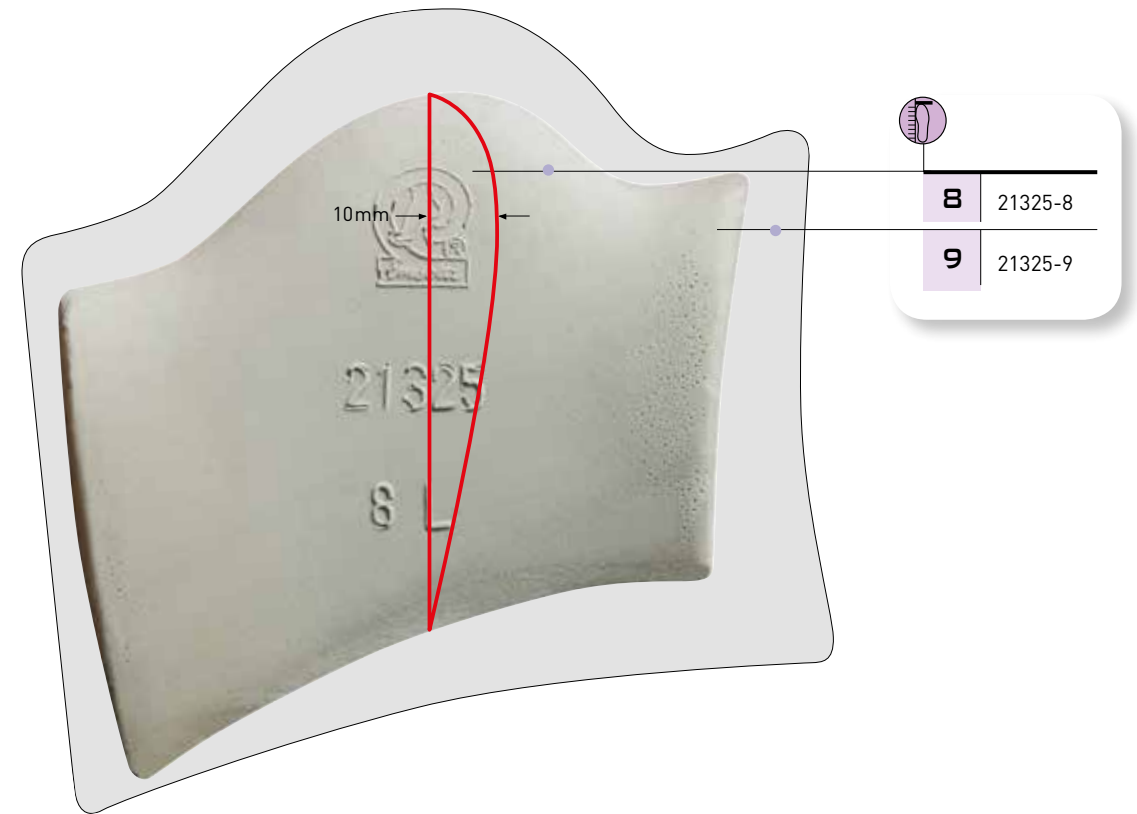

745401.

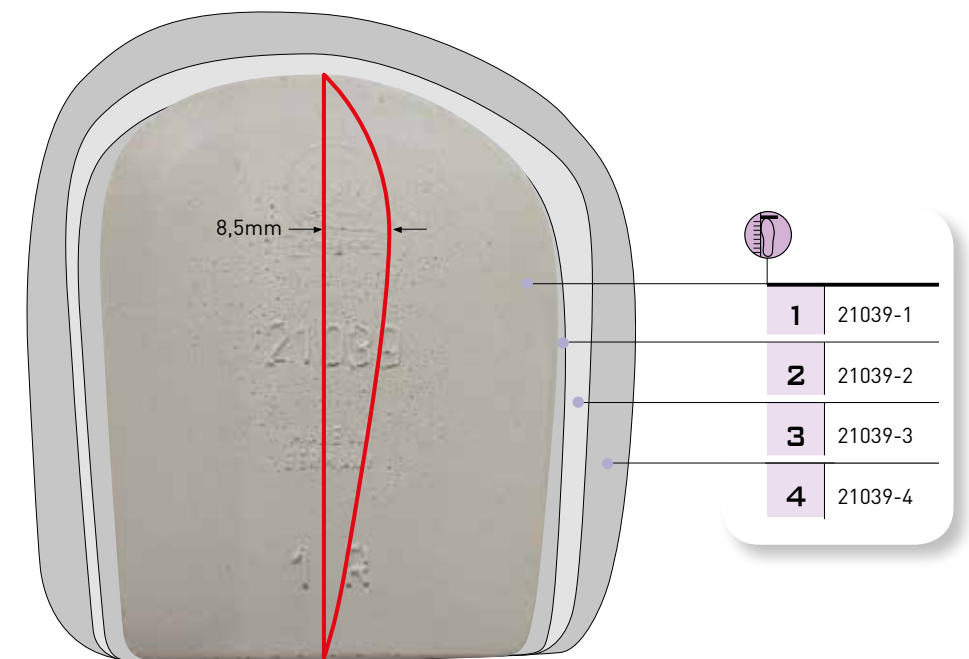

745031.



745121.

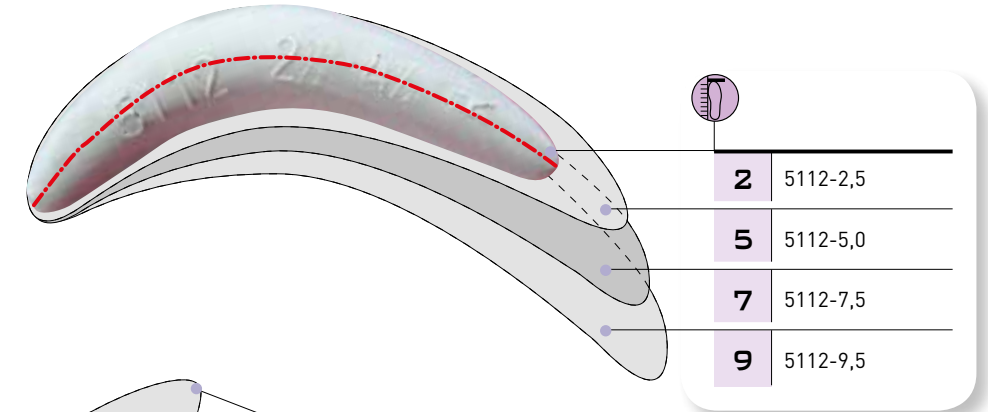

745351.

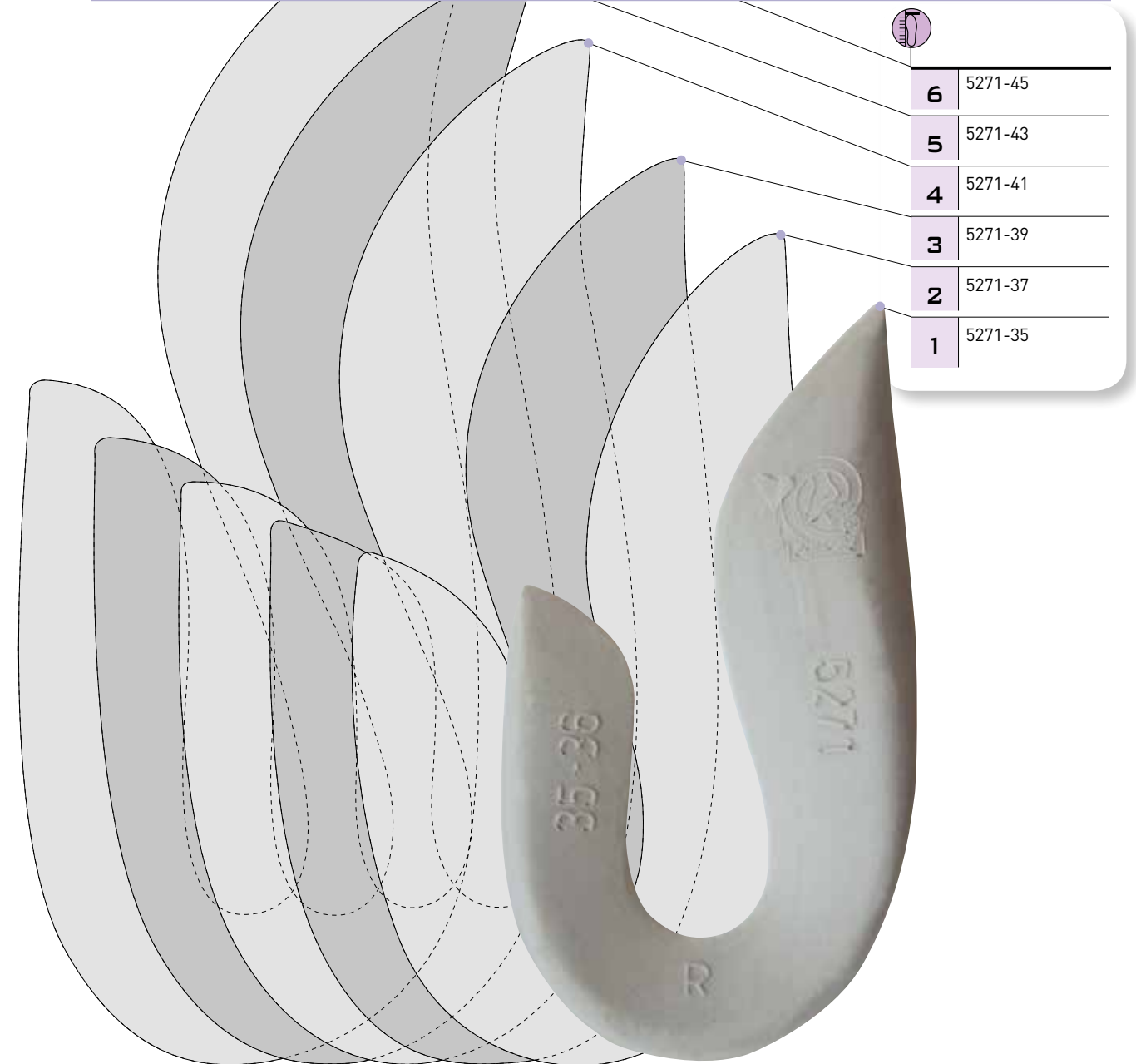

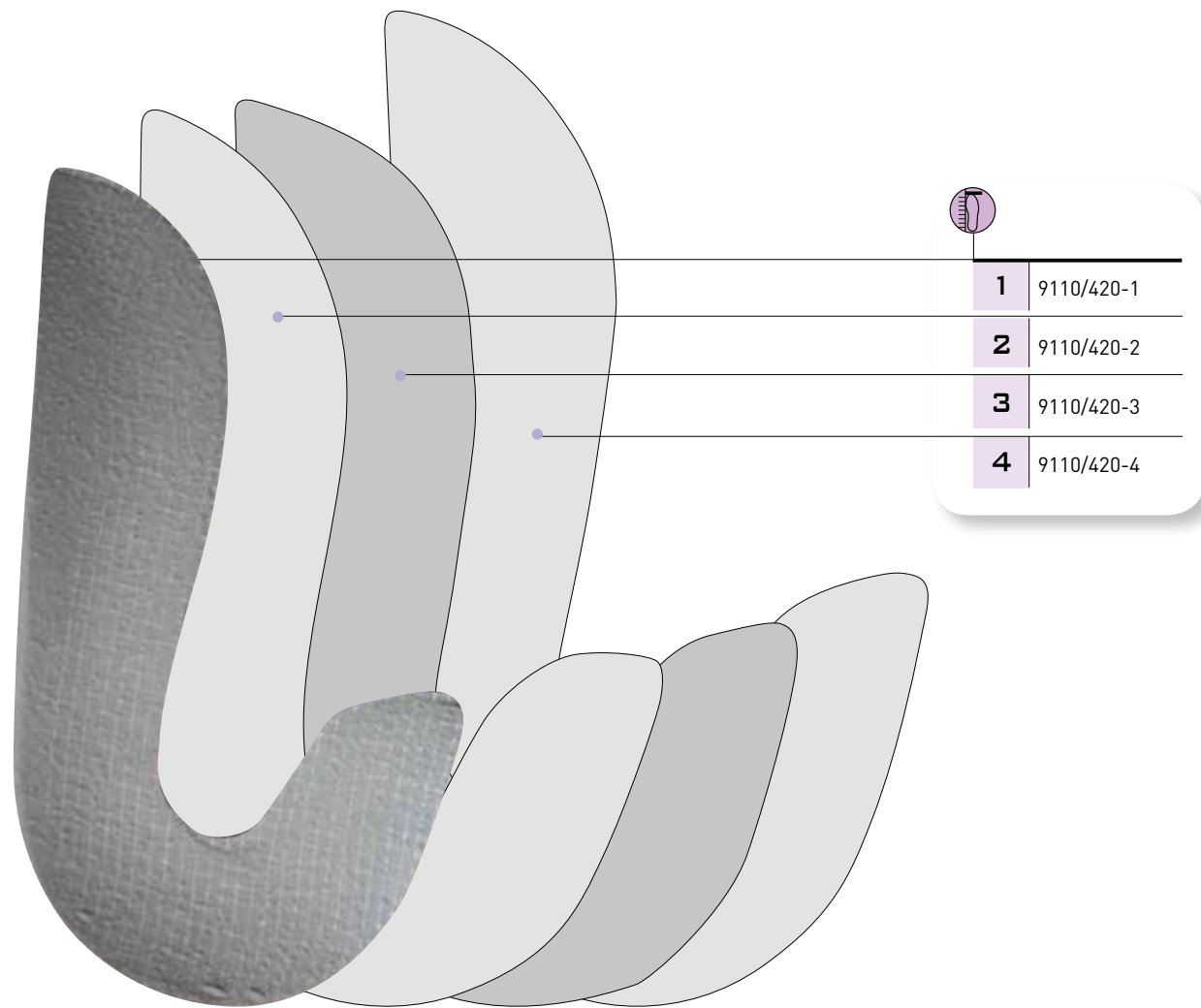

745254.



BIRKO SCHALENFORMEN
SHELL FORMS
SCHAALVORMEN
FORMES DE COQUILLE

1/2 BASIC 0410011.    1p.





	Kork cork kurk liège		
	63	64	
	breit large breed large	normal normal normaal normal	
24 > 50	•		
24 > 48		•	

1/2 BALANCE 0410011.    1p.



TIEF - PRONOUNCED - DIEP - PRONONÇÉE



	Kork cork kurk liège		Kork + Lederbezug cork + leather cover kurk + lederbekleding liège + recvr. en cuir
	90	91	93
	breit large breed large	normal normal normaal normal	normal normal normaal normal
24 > 47	•	•	•



1/2 CONTACT 0410011.    1p.



	Kork cork kurk liège		Kork + Lederbezug cork + leather cover kurk + lederbekleding liège + recvr. en cuir
	82	83	85
	breit large breed large	normal normal normaal normal	normal normal normaal normal
35 > 48	•	•	•

1/1 BASIC 0410010.    1p.



	Kork cork kurk liège	
	87	
	normal normal normaal normal	
35 > 48	•	

BIRKO 3007.

10p.

PELOTEN/STÜTZEN - PADS/SUPPORTS - PELOTEN/INBOUW - PELOTTES/SUPPORTS

Kork
cork
kurk
liège



Spreizfußpelotte splayfootpad spreadvoetpelot pelotte pied plat étalé	Stufenpelotte metatarsal pad retrocapitale pelot Pelottes rétrocapitales	Fersenkeile heel supinator hielsupinator supinateur talon	Gelenkteile wedge-top application gewelfverhoging prononciation voûte medial	Gelenkteile wedge-top application gewelfverhoging prononciation voûte lateral
4,0 cm 008	4,5 cm 011	6,0 cm 017	7,5 cm 020	6,0 cm 023
4,5 cm 009	5,5 cm 012	8,0 cm 018	9,5 cm 021	7,5 cm 024
5,0 cm 010	7,0 cm 013	9,5 cm 019	11,5 cm 022	9,5 cm 025

BIRKO 1000.

PELOTEN/STÜTZEN - PADS/SUPPORTS - PELOTEN/INBOUW - PELOTTES/SUPPORTS

Latex Schaum
latex foam
latex-schuim
mousse latex

	041	042	043
	Spreizfußpelotte splayfootpad spreadvoetpelot pelotte pied plat étalé	Fersenkissen heel cushion hielkussen talonette	Gelenkkeile arch wedge gewelfsteun revêtement voûte
eine Größe one size één maat taille unique	50p.	20p.	20p.

BIRKO 0430070.

1p.

KORKPLATTE - CORK SHEET - KURKPLAAT - PLAQUE LIÈGE



	2	3
	Kork - weich cork - soft kurk - zacht liège - doux	Kork - hart cork - hard kurk - hard liège - dur
5mm	45 x 30 cm 043007026	45 x 30 cm 043007036
10mm	45 x 30 cm 043007028	45 x 30 cm 043007037

BIRKO 0420.

1p.

SOHLEN PLATTE - SOLE SHEET - ZOOLPLAAT - PLAQUE SEMELLE

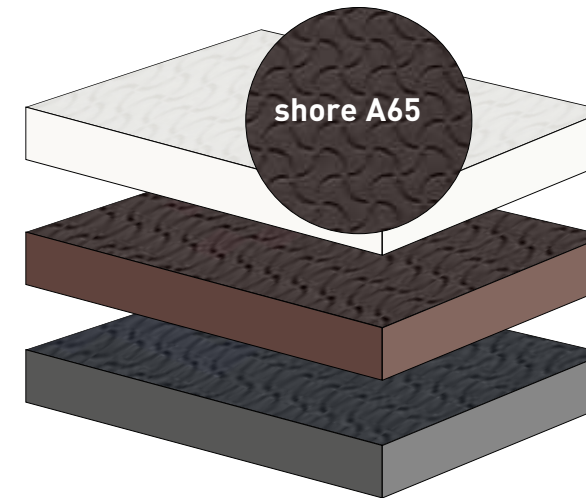

	0	1	6
	schwarz black zwart noir	braun brown bruin brun	weiß white wit blanc
07 7mm	●	●	●
10 10mm	●	●	●

BIRKO 04011.

1p.

KEILSTREIFEN - STRIPES - REPEL - BANDES BISEAUTÉES

100cm



	910	010	361
	schwarz black zwart noir	braun brown bruin brun	weiß white wit blanc
10/70	●	●	●

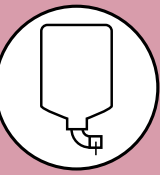

**CHEMISCHE PRODUKTE
CHEMICAL PRODUCTS
CHEMISCHE PRODUCTEN
PRODUITS CHIMIQUES**



4.01	KLEBSTOFF GLUE LIJM COLLE	4.2
4.02	LEISTEN(SCHAUM) (RESIN FOR) LASTS LEESTEN(SCHUIM) (RÉSINE POUR) FORMES	4.4
4.03	WACHS/LÖSUNGSMITTEL WAX/SOLVENTS WAS/OPLOSMIDDELEN CIRE/SOLVANTS	4.6
4.04	RENIA	4.7

AFT®
AFT-International.com

ROCKET FIX 210.



TOLUOL FREE

Rocket ist ein transparenter, einfach zu streichender Universalkleber mit perfekter Haftung, speziell für Schuhreparatur und Orthopädie geeignet.

Klebt: Gummi, Leder, PUR, TR-Material, Nylon, Textil, Holz usw. Kalt verarbeiten bei ca. 20°C. Die Flächen gut aufrauen, vom Schleifstaub befreien und beidseitig einstreichen. Der Klebstoff kann durch Wärmestrahlen jeglicher Art reaktiviert werden.

Rocket is a transparent, easy to smear universal neoprene glue with extra strong bond, especially developed for the shoe-repairer and the orthopaedist.

Glues: rubber, leather, thermorubber, nylon, textile, wood, etc. Cold glue at approx. 20°C. Roughen well, dust off and put on both sides. In case of extended waiting time, perfect adhesion can be accomplished by activating the glue.

Rocket is een transparante, gemakkelijk uit te strijken universele lijm met een perfecte hechting, speciaal ontwikkeld voor de schoenreparatie en de orthopedie.

Lijmt: rubber, leder, thermorubber, nylon, textiel, hout, enz. Koudlijmen bij ±20°C. Goed ruwen, afstoffen en beide zijden insmeren. Bij een te lange wachttijd kan men alsnog door activering zonder problemen perfect lijmen.

Rocket est une colle transparente, facile à enduire, avec une adhésion parfaite, spécialement développée pour l'orthopédie et la cordonnerie.

Colle: caoutchouc, cuir, caoutchouc TR, nylon, textile, bois, etc. Utiliser à froid à ±20°C. Carder à fond, dépeussier et en-duire les deux côtés. En cas d'attente trop longue, le collage peut s'effectuer parfaitement après réactivation à chaud.



714	11,5kg	814	11,5kg
EXTRA FIX SLOW		EXTRA FIX RAPID	
transparenter Neopren-Kleber transparent neoprene glue transparante neopreenlijm colle néoprène transparente		transparenter Neopren-Kleber transparent neoprene glue transparante neopreenlijm colle néoprène transparente	

DAS UMWELTFREUNDLICHE MEHRWEGKANNEN-SYSTEM

- umweltfreundlich:** - keine Umweltverschmutzung durch leere Verpackungen und chemischen Abfall
- sparsam:** - keine Rückstände in der Kanne - bis zum letzten Tropfen verwertbar
- Qualität:** - der Klebstoff dickt durch Ventilregulierung nicht ein - immer einfach zu streichen
- praktisch:** - abfüllen war nie so praktisch
- universell:** - klebt alles ausser PVC

THE UNIQUE ECOLOGICAL SYSTEM WITH A RECYCLING PACKAGING

- ecological:** - no empty cans or chemical waste
- economical:** - no remainders in the can: usable until the last drop of glue
- quality:** - the glue can't get thicker in the can, thanks to the valvesystem
- practical:** - very practical to draw off with the unique tap
- universal:** - glues everything with exception of PVC

HET UNIEKE MILIEUVRIENDELIJKE SYSTEEM MET HERBRUIKBARE VERPAKKING

- milieuvriendelijk:** - geen lege bussen of chemisch afval meer
- zuinig:** - geen bodemresten: tot de laatste druppel bruikbaar
- kwaliteit:** - lijm kan niet indikken - blijft altijd vloeibaar tot de laatste druppel, dankzij het unieke ventielsysteem
- praktisch:** - gemakkelijk afvullen dankzij de unieke kraan
- universeel:** - lijmt alles met uitzondering van PVC

LE SYSTEME UNIQUE DE BIDONS ECOLOGIQUES ET RECYCLABLES

- écologique:** - plus de vidanges et restants chimiques à jeter
- économique:** - pas de dépôt: le bidon se vide jusqu'à la dernière goutte
- qualité:** - la colle reste toujours aussi liquide par le système de valve
- pratique:** - très pratique grâce à son robinet et système unique
- universelle:** - colle toutes matières, à l'exception de PVC

SLOW		
OFFENE ZEIT OPEN TIME OPEN TIJD TEMPS OUVERT	beim hammern: by hammering: bij hameren: en martelant: 15-60 min.	beim pressen: by pressing: bij persen: à la presse: 15-90 min.
RAPID		
OFFENE ZEIT OPEN TIME OPEN TIJD TEMPS OUVERT	beim hammern: by hammering: bij hameren: en martelant: 3-30 min.	beim pressen: by pressing: bij persen: à la presse: 3-45 min.

FIX 210.



3	EXTRA FIX SLOW	4	EXTRA FIX RAPID	5	PUR FIX UNIVERSAL
	transparenter Neopren-Kleber transparent neoprene glue transparante neopreenlijm colle néoprène transparente		transparenter Neopren-Kleber transparent neoprene glue transparante neopreenlijm colle néoprène transparente		PU-Kleber PU glue PU-lijm colle PU



02	2kg				
05	4kg				
10	10kg				

TOLUOL FREE



MIRACLE GLUE 20.



CYANOACRYLATE



06	30	40
V60	V300	FLEX
2	5	5
20 gr.	50 gr.	50 gr.



N/F				
D/E				
N/F/D/E				

Ab 1000 Stück pro Sorte auch erhältlich mit eigenem Label.
As from 1000 pieces per type also available with your own label.
vanaf 1000 stuks per soort ook verkrijgbaar met eigen label.
A partir de 1000 pièces aussi en vente avec votre propre étiquette.

RESINFORM



Regal
rack
rek
étagère
6030000210

BAG-IN-BOX



revolutionär:

- praktisches Abfüllen
- Präzision beim Wiegen
- kein Schmutz, kein Schmieren

revolutionary:

- practical and fast
- easy to get a very precise weight
- no spilling

revolutionair:

- snel en superpraktisch
- precisie bij het wegen
- geen gemors

révolutionnaire:

- pratique et plus rapide
- facile à peser le poids exact
- pas de gaspillage

1. **EXTRA RESINFORM**
Leistenschaum
Resin for lasts
Leestenschuim
Résine pour formes



EXTRA BAG-IN-BOX

	24100A	24100B
	POLYOL	ISOCYANATE
	10kg	10kg
100 cm ³	31 gr	31 gr
200 cm ³	62 gr	62 gr
400 cm ³	124 gr	124 gr
600 cm ³	186 gr	186 gr
800 cm ³	248 gr	248 gr
1000 cm ³	310 gr	310 gr
1200 cm ³	372 gr	372 gr
1400 cm ³	434 gr	434 gr
1600 cm ³	496 gr	496 gr

2. **EXTRA RESINFORM**
Leistenschaum
Resin for lasts
Leestenschuim
Résine pour formes



A - POLYOL	5kg	24005A
A - POLYOL	10kg	24010A
B - ISOCYANATE	5kg	24005B
B - ISOCYANATE	10kg	24010B



VERSCHIEDENES - VARIOUS - DIVERSE - DIVERS

3. **TS-Boy Sparbehälter**
Economy glue container
Lijmpot
Récipient économique

Small - 0,4L. **6078351000**
Ersatzpinsel/spare brush **6078351001**
vervangborstel/pinceaux remplaçant

Medium - 0,9L. **6078352000**
Ersatzpinsel/spare brush **6078352001**
vervangborstel/pinceaux remplaçant
rund/round/rond/rond **6078352002**
flach/flat/plat/plat

Large - 1,5L. **6078353000**
Ersatzpinsel/spare brush **6078353001**
vervangborstel/pinceaux remplaçant
nr 10 **6078353002**
nr 12



4. **TRENNMITTEL**
5L. **24300**



5. **Mischbecher (25St.)**
cup for mixing (25p.)
mengbeker (25st.)
gobelet pour mélanger (25p.)

small - 500 ml. **25200**
large - 2 l. **25202**



6. **FOOTPRINT**
Trittschaum (25St.)
footprint (25p.)
afdrukschuim (25st.)
boîte d'empreintes (25p.)

normal - 32 x 15 x 4 cm **7000**
large - 34 x 17 x 5,5 cm **70006**



7. **FOOTDOC**
Druck sensitiv Papier, 100 sheets
pressure sensitive paper, 100 sheets
drukgevoelig papier, 100 vel
papier sensible pression, 100 sheets **79001**



8. **Ruhrstab Holz (5 St.)**
stirring stick, wood (5 p.)
houten mengstokjes (5 stuk)
spatule en bois (5 p.) **25210**



4.03

WACHS/LÖSUNGSMITTEL WAX/SOLVENTS WAS/OPLOSMIDDELEN CIRE/SOLVANTS

1. **HOOCO** - 130g
farbwachs
triangle wax
was driehoekig
cire triangulaire



schwarz/black/zwart/noir **23500**
d.braun/d. brown/d.bruin/brun f. **23501**
farblos/colourless/kleurloos/incolore **23507**
m.braun/m. brown/m.bruin/brun m. **23511**



2. **WACHS IT** - 1kg
wachs tinte
liquid wax
wasinkt
cire



schwarz/black/zwart/noir **2310**
braun/brown/brun/brun **2311**
farblos/colourless/kleurloos/incolore **2317**



3. **TOP FINISH** - 75ml
in 16 Farben
all 16 colours
alle 16 kleuren
toutes les 16 couleurs



238.



100 colourless	009 white	011 nickle	005 light beige	007 sand	035 middle brown	054 smoke	046 dark brown
022 bison	044 schlamm	017 beige grey	060 light grey	056 stone grey	081 black	078 dark blue	018 bambus

Farbabweichungen zwischen dem Farbdruck und dem Originalprodukt sind möglich.
Colour differences between print and original product are possible.
Kleurverschillen tussen het drukwerk en het origineel product zijn mogelijk.
Des différences de couleur entre l'imprimerie et la produit originale sont possible.

4. **ACETON**
Farblösemittel
paint remover
verfoplosser
decapant



1l. **22101**
5l. **22105**



5. **TOLUEEN**
Kleberlösemittel
glue solvent
lijmoplosser
dissolvant de colle



1l. **22201**
5l. **22205**



4.04

RENIA



1. **RENIA MULTI-COLLE**
2120201 1l
2120204 4kg
2120210 10kg



2. **RENIA COLLE DE COLOGNE**
2120301 1l
2120304 4kg
2120310 10kg



3. **RENIA FORTE**
2120401 1l
2120410 10kg



4. **RENIA TOP-FIT**
2120508 8kg



5. **RENIA KLEB-FEST**
2120606 60g
2120609 90g



6. **RENIA VULKOFEST**
2120704 4kg
2120710 10kg



7. **RENIA ORTEC**
2120901 1l
2120904 4kg
2120910 10kg



8. **RENIA GUMMILÖSUNG**
2121000 580g
2121004 4kg



9. **RENIA SYNTIC**
2121500 90g
2121501 1l
2121504 4kg



10. **RENOL 'ASTI'**
2121600 640g
2121604 4kg



11. **RENIA AQUILIM**
2121703 Aquilim 250 - 3kg
2121803 Aquilim 315 - 3kg



12. **RENIA SCHNELLKLEBER/VERDÜNNER**
2122101 1l
2122105 5l
2122112 12l



13. **RENIA DESOHL**
2122201 1l
2122205 5l



14. **RENIA PRIMER PUR**
2122404 85ml
2122425 250ml



15. **RENIA REHAGOL**
2122504 85ml
2122525 250ml





LEDER
CUIR
LEDER
LEATHER

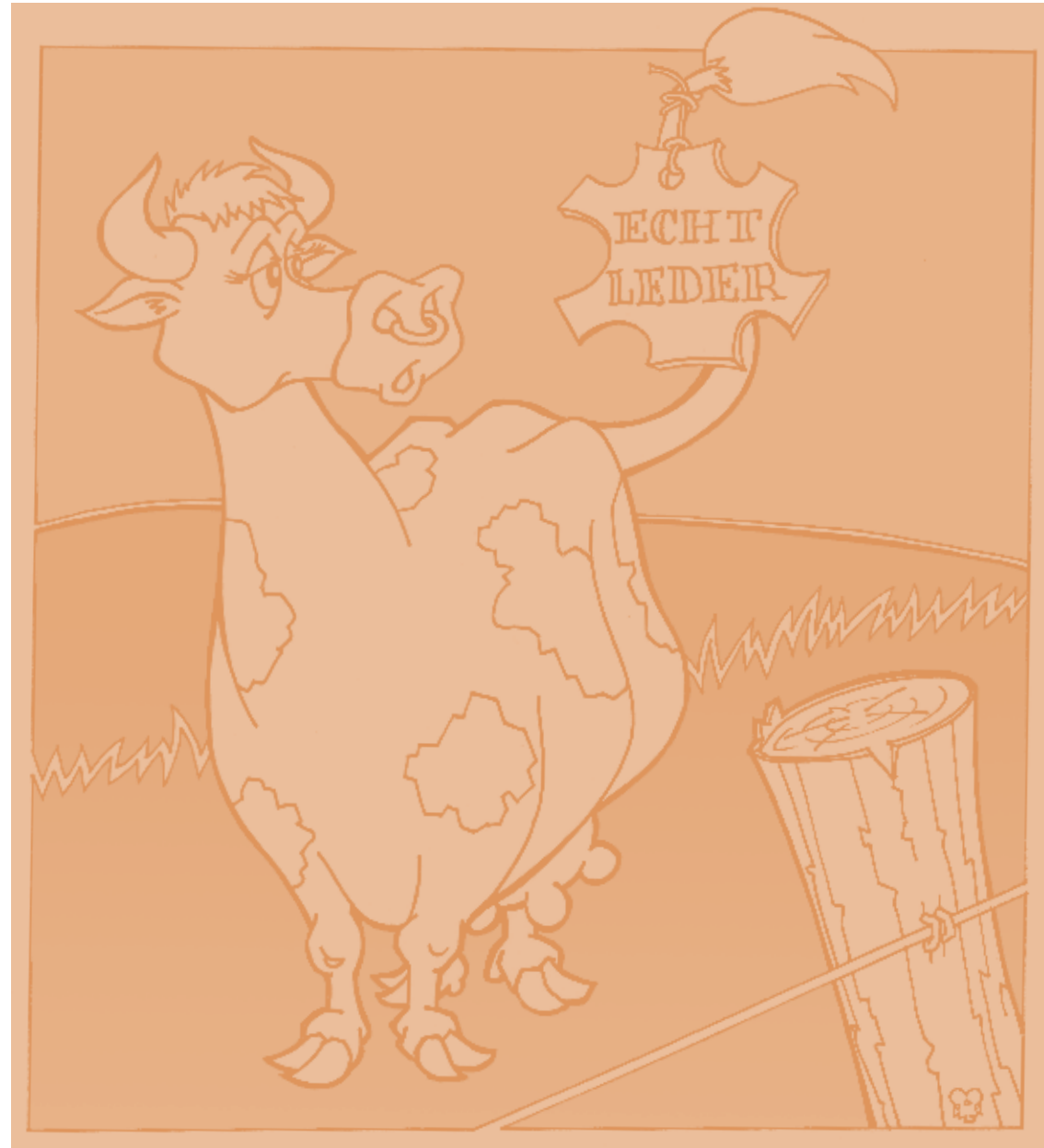

5.01	BODENLEDER SOLE LEATHER ZOOLEDERS CUIRS À SEMELLES	5.2
5.02	BLANKLEDER VEGETAL TANNED LEATHER BLANKLEDERS CUIRS VÉGÉTAL	5.3
5.03	FUTTERLEDER LEATHER LINING VOERINGLEDERS CUIRS DOUBLURE	5.4
5.04	LEDERARTIKEL LEATHER PARTS LEDER ARTIKELEN ARTICLES EN CUIR	5.6

AFT[®]
AFT-International.com

5.01

**SOHLENLEDER
SOLE LEATHER
ZOOLEDERS
CUIRS À SEMELLES**

CROUPONS 311.

CROUPONS - BENDS - CROUPONS - CROUPONS



Spitzenqualität, Naturprodukt, beste Wahl
Altgerbung - sehr abriebfest - flexibel

first choice extraordinary quality
oaktanned - very strong - flexible

Naturprodukt in allerbeste kwaliteit
traag geloid - uiterst sterk - flexibel

1er choix qualité extraordinaire
tannage lent - très solide - flexible

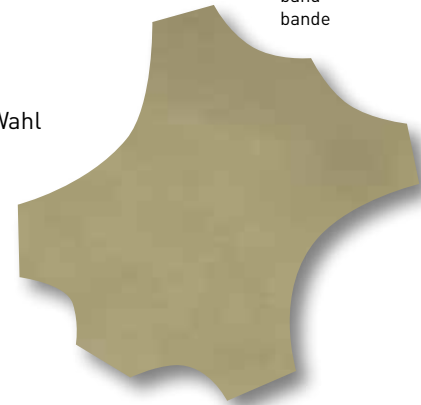

2,5-3,0 mm **3112530**
3,1 -3,5 mm **3113135**
3,6-4,0 mm **3113640**
4,1-4,5 mm **3114145**
4,6-5,0 mm **3114650**
5,1-5,5 mm **3115155**

CROUPONS 3241

STANZRESTE - CUTTING RESTS - AFVAL ASSORTIMENT - ASSORTIMENT DE DÉCHET

EXTRA 321.

SOHLEN - SOLES - ZOLEN - SEMELLES

→ part 11.01

		1	2	3	7	4	5	6	8	9
		Damen-1 women-1 dames-1 dames-1	Damen-2 women-2 dames-2 dames-2	Damen-3 women-3 dames-3 dames-3	Damen-7 women-7 dames-7 dames-7	Herren-4 men-4 heren-4 hommes-4	Herren-5 men-5 heren-5 hommes-5	Herren-6 men-6 heren-6 hommes-6	Herren-8 men-8 heren-8 hommes-8	Herren-9 men-9 heren-9 hommes-9
20	2,0-2,5 mm.	•	•	•	•	•	•	•	•	•
25	2,5-3,0 mm.	•	•	•	•	•	•	•	•	•
31	3,1-3,5 mm.	•	•	•	•	•	•	•	•	•
36	3,6-4,0 mm.		•	•	•	•	•	•	•	•
41	4,1-4,5 mm.		•		•	•	•	•	•	•
46	4,6-5,0 mm.					•	•	•	•	•
51	5,1-5,5 mm.					•	•	•	•	•

Option: Auf Anfrage liefern wir Ihnen die Sohlen geschliffen und geprägt.
option: If requested the soles can be delivered buffed and stamped.
optie: De zolen kunnen gestempeld en geschuurd worden geleverd.
option: Nous pouvons vous livrer les semelles cardées et estampées.



5.02

**BLANKLEDER
VEGETAL TANNED LEATHERS
BLANKLEDERS
CUIRS VÉGÉTAL**

HÄLSE - NECKS - HALZEN - COLLETS



- Spaltcroupon natur|Splitted bend natural| Splitcroupon naturel|Croûte de croupon naturel**
Für Brandsohlen und Basis für Einlagen
For insoles and base of orthotics.
Voor binnenzolen en basis van steunzolen
Pour semelles intercalaires et bases des semelles orthopédiques
0,80-1,00 mm **333008**
1,00-1,25 mm **333010**
1,25-1,50 mm **333012**
1,50-1,90 mm **333015**
- Spaltleder zugerichtet|Splitleather pigmented| Rundscroute gepigmenteerd|Croûte de vachette pigmentée**
Basis für Einlagen, Einlegesohlen
Base for orthotics, insoles
Basis voor steunzolen, binnenzolen
Base des semelles orthopédiques, semelles intérieures
1,2-1,5 mm **333112**
- Ortho - Blanklederhals natur|Necks natural| Vormhals naturel|Collet à mouler naturel**
Für Einlagen, Brandsohlen, Bandagen, Gürtel usw.
For orthotics, insoles, bandages, belts etc.
Voor steunzolen, binnenzolen, bandages, riemen etc.
Pour semelles orthopédiques, semelles intercalaires, bandages, ceintures etc.
1,2-1,4 mm **330012**
1,4-1,6 mm **330014**
1,8-2,0 mm **330018**
2,0-2,5 mm **330020**
2,5-3,0 mm **330025**
- Ortho - Hals|Neck|Hals|Collet**
Für Einlagen, Orthesen, Prothesen
For orthotics, orthosis, prothesis
Voor steunzolen, orthesen, prothesen
Pour semelles orthopédiques, orthèses, prothèses
2,5 mm **331225**
- Ortho - Rindlederhaut|Double bend|Dubbele rundscroupon|Croupon double**
Natur gebläntzt, 1. Wahl. Für Einlagen, Orthesen, Prothesen
Natural glazed, 1st Choice. For orthotics, orthosis, prothesis
Naturel glacé, 1ste keuze. Voor steunzolen, orthesen, prothesen
Naturel glacé, 1er choix. Pour semelles orthop., orthèses, prothèses
1,25-1,5 mm **33400**
- Altgerber - Hals für Kappen und Orthesen|Neck for counters and orthoses| Hals contreforten orthesen|Collet contrefort et ortheses**
1,5-2,0 mm **33202**
2,0-2,5 mm **33203**
2,5-3,0 mm **33204**
- Podocuir - 95% Lederfaser Komposite|95% leather fibre compound| 95% natuurlijke ledervezel-compositiet|composé de 95% de fibres de cuir naturel**
Abwaschbar, ständige Qualität und Stärke. Erträgt Transpiration.
Für Brandsohlen und Basis für Einlagen
Washable, permanent quality and thickness. Withstands transpiration.
For insoles and base of orthotics.
Afwasbaar, constante kwaliteit en dikte. Weerstaat transpiratie.
Voor binnenzolen en basis van steunzolen
Lavable, qualité et épaisseurs constantes. Résiste à la transpiration.
Pour semelles intercalaires et bases des semelles orthopédiques
1,1 mm - 100x140cm **335011**
1,4 mm - 100x140cm **335014**

**NEU
NEW
NIEU
NOUVEAU**

KALB - CALF - KALF - VEAU



- | | | |
|--|---|--|
| 1. creme/cream/crème/crème
0,6-0,8 mm 341006
0,6-0,8 mm perfo 341006SP
0,8-1,0 mm 341008
0,8-1,0 mm perfo 341008SP
1,0-2,0 mm 341010
1,0-2,0 mm perfo 341010SP | 4. cognac
0,8-1,0 mm 341608
0,8-1,0 mm perfo 341608SP | 8. safran
0,8-1,0 mm 34220 |
| 2. natural/natural/natuur/nature
0,8-1,0 mm 341208
0,8-1,0 mm perfo 341208SP | 5. braun/brown/bruin/brun
0,8-1,0 mm 341808
0,8-1,0 mm perfo 341808SP | 9. vegetal
0,8-1,0 mm cream 342506
0,8-1,0 mm camel 342708 |
| 3. camel
0,7-0,9 mm 341407
0,7-0,9 mm perfo 341407SP | 6. schwarz/black/zwart/noir
0,8-1,0 mm 341908
0,8-1,0 mm perfo 341908SP | 10. natur- forest
0,8-1,0 mm 341108
0,8-1,0 mm perfo 341108SP |
| | 7. beige - Forest
0,8-1,0 mm 342008
0,8-1,0 mm perfo 342008SP | 11. taupe - forest
0,8-1,0 mm 342208
0,8-1,0 mm perfo 342208SP |

RIND - COW - RUND - BOVIN

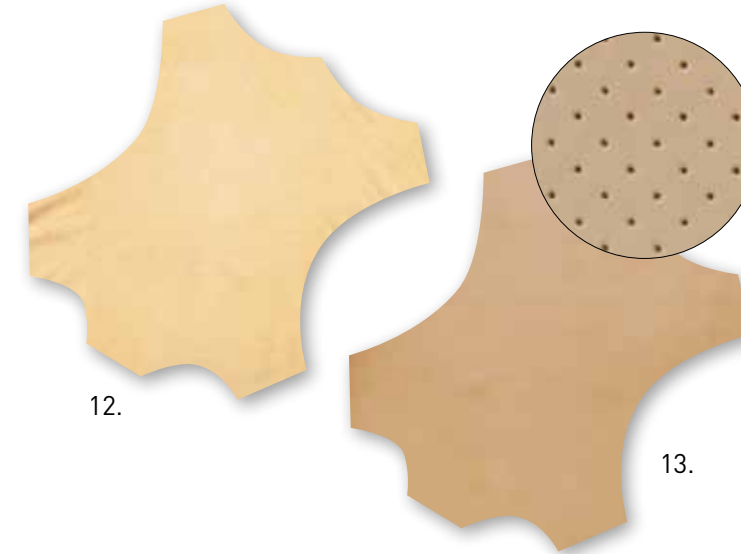

12. Extrem flexibele vollständige Fellen Leder, hautfarbe
Very flexible complete hide, skin colour
flexibele volledige grote vellen, huidskleur
Peaux complètes, très flexibles, couleur chair

0,6-0,7 mm **353106**

13. **Quality**
1,25 mm **353300**
1,25 mm perfo **353300P**

ZIEGEN/SCHAF - GOAT/SHEEP - GEIT/SCHAAP - CHÈVRE/BAZANE



14. Ziegenfutter blond natur
Goatlining blond natural
Geitenvoering blond naturel
Chèvre doublure blonde naturel

0,6 - 0,8 mm **3550**
0,6 - 0,8 mm perfo **3550P**

15. Skiver beige
0,5 mm **3557**

16. Schaffutterleder mit Peccari-Narben
Sheeplining peccari print
Bazaan peccari print
Bazane grain de peccari
357213

SCHWEIN - PORC - VARKEN - PORC

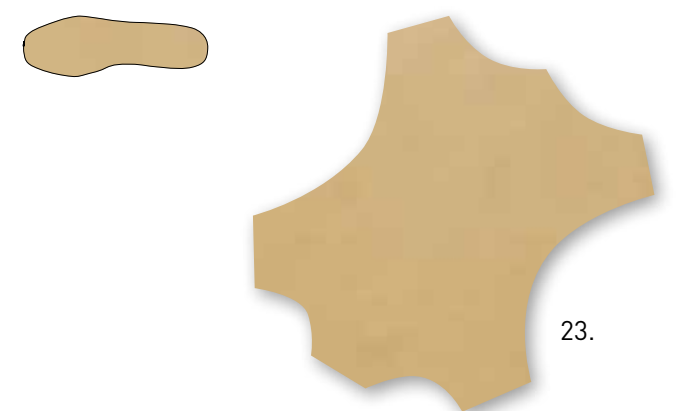

23. spalt velouté
split velouté
croute velouté
croute velouté

35786

EINLEGESOHLE 5139.    12p.

EINLEGESOHLE - INSOLE - INPLAKZOOŁ - SEMELLE À COLLER EN CUIR



	Leder leather leder cuir	36 > 48
<input type="checkbox"/>	schwarz black zwart noir	•
9	Farbe sortiert assorted colours kleurassortiment coloris assortis	•

FUTTER 360.    25p.

FERSENFUTTER - BACKLINING - HIELVOERING - DOUBLURE DE TALON



		1	2	3	4
		Damen women dames	Herren men heren	Herren XL men XL heren XL	Stiefel boot laars botte
<input type="checkbox"/>	schwarz black zwart noir		•	•	
1	crust crust crust	•		•	
6	Farbe sortiert assorted colours kleurassortiment coloris assortis		•	•	•

RIESTER 3605  150

RIESTER GESCHÄRFT - INSERTS SKIVED - LIJMLAPJES GESCHALMD - CACHE DÉCHIRURE ROGNÉE



Farbe sortiert
assorted colours
kleurassortiment
coloris assortis

GRIFFE  1

GRIFFE - HANDLES - HANDVATTEN - POIGNÉES

in 3 Farben.
all 3 colours.
alle 3 kleuren.
toutes les 3 couleurs.



1. Leder/leather/leder/cuir
36344
2. Leder/leather/leder/cuir
36346
3. Leder/leather/leder/cuir
363487
4. Skai/imitation leather/skai/skai
363511
5. Leder/leather/leder/cuir
363520
6. Skai/imitation leather/skai/skai
363551
7. Leder/leather/leder/cuir
363562

GRIFFE 363.    1







GRIFFE - HANDLES - HANDVATTEN - POIGNÉES

in 7 Farben
all 7 colours
alle 7 kleuren
toutes les 7 couleurs

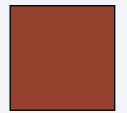

1	Wulsthenkel 50cm. cording strap 50cm. markttaas 50cm. bourrelet 50cm.	•
----------	--	---

 **LEDER/LEATHER/LEDER/CUIR**

						
00	01	11	03	04	05	06
schwarz black zwart noir	dunkelbraun dark brown donkerbruin brun foncé	mittelbraun medium brown middelbruin brun moyen	cognac brandy cognac cognac	beige beige beige beige	dunkelblau dark blue donkerblauw bleu foncé	weiß white wit blanc

Farbabweichungen zwischen dem Farbdruck und dem Originalprodukt sind möglich.
Colour differences between print and original product are possible.
Kleurverschillen tussen het drukwerk en het origineel product zijn mogelijk.
Des différences de couleur entre l'imprimerie et la produit originale sont possible.



EINZELHANDEL
RETAIL
WEDERVERKOOP
ARTICLES DE REVENTE

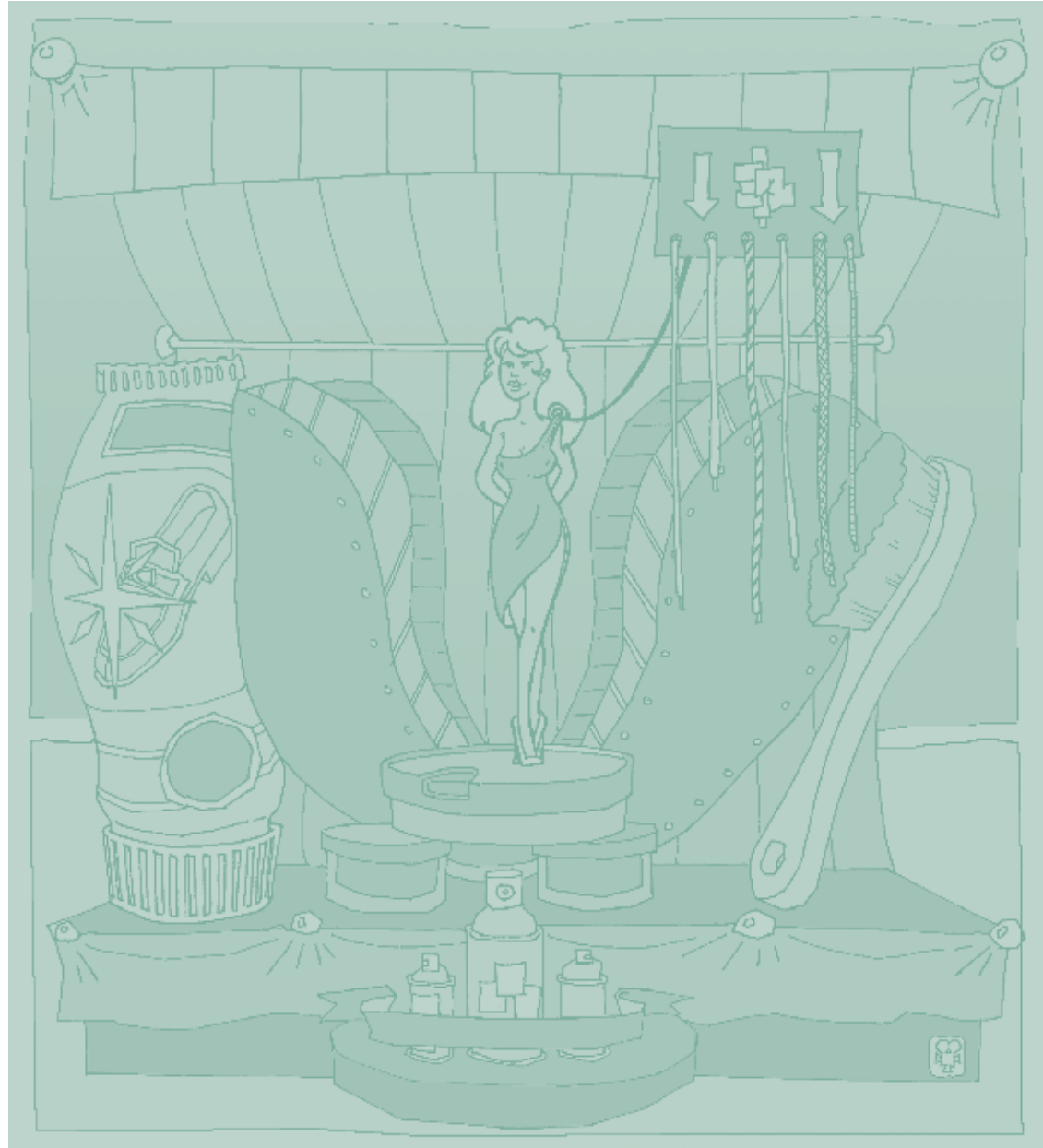

8.01	SCHNÜRSENKEL LACES VETERS LACETS	8.2
8.02	EINLEGESOHLN INSOLES INLEGZOLEN SEMELLES INTERIEURES	8.10
8.03	SCHUHPFLEGEMITTEL SHOE CARE ONDERHOUDSPRODUCTEN PRODUITS D'ENTRETIEN	8.18
8.04	FURNITUREN SHOE ACCESSORIES SCHOENACCESSOIRES ACCESSOIRES CHAUSSURES	8.24

AFT[®]
AFT-International.com

5810 oder 5860.

flach-schmal
flat-fine
plat-smal
plat-fine

	045	060	075	090	100	120	150	180	220
	45cm	60cm	75cm	90cm	100cm	120cm	150cm	180cm	220cm
	2	3	4	5	5	6	8	10	14
		12pr.	10pr.	9pr.		8pr.	7pr.	6pr.	6pr.
	101	●		●		●		●	●
	102		●	●		●	●	●	●
	126	●		●		●			
	132	●	●	●		●	●		

5813 oder 5863.

flach-Sport
flat-sport
plat-sport
plat-sport

	045	060	075	090	100	120	150	180	200
	45cm	60cm	75cm	90cm	100cm	120cm	150cm	180cm	200cm
	2	3	4	5	5	6	8	10	12
					8pr.	7pr.	6pr.	6pr.	5pr.
	101				●	●	●	●	●
	102				●	●	●	●	●
	126				●	●	●	●	
	132				●	●			
	172					●	●	●	
	9313					●	●	●	
	9625					●	●	●	
	9626					●	●	●	
	9627					●	●	●	
	9628					●	●	●	

5814 oder 5864.

Kordel
cord
koord
cordelé

	045	060	075	090	100	120	150	180	200
	45cm	60cm	75cm	90cm	100cm	120cm	150cm	180cm	200cm
	2	3	4	5	5	6	8	10	12
		12pr.	10pr.	9pr.	8pr.	8pr.	6pr.	6pr.	6pr.
	100		●	●	●	●			
	101	●	●	●	●	●	●		●
	102	●	●	●	●	●	●	●	●
	111		●	●	●	●			
	112		●	●	●				
	117		●	●	●	●	●		
	118		●	●		●			
	122	●	●	●	●	●			
	123		●	●	●	●			
	126	●	●	●	●	●	●	●	●
	128		●	●	●	●			
	129		●	●	●	●			
	132	●	●	●	●	●	●	●	●
	133			●	●	●			
	139		●	●	●	●			
	146		●	●	●	●			
	147		●	●	●	●			
	148	●	●	●	●	●			
	152		●	●	●	●			
	153			●					
	172		●	●	●	●	●	●	
	251			●					
	D47			●	●	●	●		
	D48			●	●	●	●	●	
	8351		●	●	●	●	●	●	

Erhältlich in:
Available in:
Verkrijgbaar in:
En vente dans:

● Klarpack
clear pack
transparente verp.doos
emballage boîte



● Klarpack oder Blister
Clear pack or blister
Transparente verp.doos of blister
Emballage boîte ou blister



Farbabweichungen zwischen dem Farbdruck und dem Originalprodukt sind möglich.
Colour differences between print and original product are possible.
Kleurverschillen tussen het drukwerk en het origineel product zijn mogelijk.
Des différences de couleur entre l'imprimerie et la produit originale sont possible.





5815.

Arbeitsschuh
working boots
werkschoenen
chaussures de travail

	045	060	075	090	100	120	150	180	200
	45cm	60cm	75cm	90cm	100cm	120cm	150cm	180cm	200cm
	2	3	4	5	5 8pr.	6	8	10	12
	102				●				



5816.

allrounder

	045	060	075	090	100	120	150	180	220
	45cm	60cm	75cm	90cm	100cm	120cm	150cm	180cm	220cm
	2	3	4	5	5	6	8	10	14
		12pr.	10pr.	9pr.		8pr.	7pr.	6pr.	6pr.
	102		●	●		●			
	132		●	●		●			
	D9835		●	●		●			
	D9836		●	●		●			

5819.

rund-extra dick
round-extra thick
rond-extra dik
rond-extra large

	045	060	075	090	100	120	150	180	200
	45cm	60cm	75cm	90cm	100cm	120cm	150cm	180cm	200cm
	2	3	4	5	5	6	8	10	12
			6pr.	5pr.		4pr.	4pr.		
	101			●		●			
	102		●	●		●	●		
	132		●	●		●	●		

Farbabweichungen zwischen dem Farbdruck und dem Originalprodukt sind möglich.
Colour differences between print and original product are possible.
Kleurverschillen tussen het drukwerk en het origineel product zijn mogelijk.
Des différences de couleur entre l'imprimerie et la produit originale sont possible.

Erhältlich in:
Available in:
Verkrijgbaar in:
En vente dans:

● Klarpack
clear pack
transparente verp.doos
emballage boîte



● Klarpack oder Blister
Clear pack or blister
Transparente verp.doos of blister
Emballage boîte ou blister





5822 oder of ou **5872.**

modischer Rundsenskel
trendy round
trendy rond
rond, à la mode

	045	060	075	090	100	120	150	180	200
	45cm	60cm	75cm	90cm	100cm	120cm	150cm	180cm	200cm
	2	3	4	5	5	6	8	10	12
		8pr.	7pr.	6pr.	6pr.	5pr.	5pr.	4pr.	4pr.
	068		●	●		●			
	096		●	●					
	097		●	●		●			
	101		●	●	●	●			
	102	●	●	●	●	●	●	●	●
	126		●	●	●	●	●		●
	132	●	●	●	●	●	●	●	
	8350	●	●	●		●			
	9257			●		●	●		
	9315			●		●	●	●	
	9317					●	●	●	
	9318			●		●	●	●	
	9629						●	●	
	9630						●	●	
	9631						●	●	
	9632						●	●	
	9633						●	●	
	9702			●	●	●			
	9703			●	●	●			
	9832						●	●	●

5823 oder of ou **5873.**

rund-dick
round-thick
rond-dik
rond-large

	045	060	075	090	100	120	150	180	200
	45cm	60cm	75cm	90cm	100cm	120cm	150cm	180cm	200cm
	2	3	4	5	5	6	8	10	12
		7pr.	6pr.	6pr.		5pr.			
	102		●	●		●			
	123			●					
	132		●	●		●			

5824.

Stiefel
boots
Laarzen
bottes

	045	060	075	090	100	120	150	180	200
	45cm	60cm	75cm	90cm	100cm	120cm	150cm	180cm	200cm
	2	3	4	5	5 8pr.	6	8	10	12
	102				●				
	117				●				
	126				●				
	132				●				

5826 5876.

flach-breit
flat-large
plat-breed
plat-large

	045	060	075	090	100	120	150	180	200
	45cm	60cm	75cm	90cm	100cm	120cm	150cm	180cm	200cm
	2 10pr.	3 9pr.	4 8pr.	5 8pr.	5	6 7pr.	8 6pr.	10	12
	100			●					
	101	●	●	●		●	●		
	102	●	●	●		●	●		
	111		●	●		●	●		
	112		●	●		●			
	117		●	●		●	●		
	122	●	●	●		●			
	126	●	●	●		●	●		
	128		●	●					
	129		●	●		●			
	132	●	●	●		●	●		
	139					●			
	147		●			●			
	148		●	●		●			
	150		●			●			
	152		●	●		●			
	219			●		●	●		
	D05		●	●					
	D06	●	●	●		●			

5830 5880.

rund-dunn
round-thin
rond-dun
rond-fin

	045	060	075	090	100	120	150	180	200
	45cm	60cm	75cm	90cm	100cm	120cm	150cm	180cm	200cm
	2 15pr.	3 12pr.	4 10pr.	5 9pr.	5 9pr.	6 8pr.	8 8pr.	10 7pr.	12 6pr.
	100	●	●						
	101	●	●	●		●			
	102	●	●	●	●	●	●	●	●
	111	●	●	●					
	112		●	●					
	117	●	●	●	●				
	118			●	●				
	122		●	●	●		●		
	123		●	●	●		●		
	126		●	●	●		●		
	128	●	●	●	●		●		
	129	●	●	●	●		●		
	132	●	●	●	●		●	●	●
	133			●	●				
	139		●	●	●				
	147		●	●	●				
	148	●	●	●	●				
	172			●					
	276		●	●	●				

5831 5881.





Kordel
cord
koord
cordelé

	045	060	075	090	100	120	150	180	200
	45cm	60cm	75cm	90cm	100cm	120cm	150cm	180cm	200cm
	2	3 9pr.	4 8pr.	5 7pr.	5	6 5pr.	8	10	12
	102	●	●	●		●			
	132	●	●	●					
	4116			●					

Farbabweichungen zwischen dem Farbdruck und dem Originalprodukt sind möglich.
Colour differences between print and original product are possible.
Kleurverschillen tussen het drukwerk en het origineel product zijn mogelijk.
Des différences de couleur entre l'imprimerie et la produit originale sont possible.



5835 [•] oder [•] 5885.  

rund-extra dünn - Ø2,5mm
round-extra thin
rond-extra dun
rond-extra fin

	045	060	075	090	100	120	150	180	200
	45cm	60cm	75cm	90cm	100cm	120cm	150cm	180cm	200cm
	2	3	4	5	5	6	8	10	12
		10pr.	9pr.	8pr.					
	102	•	•	•					
	123	•	•	•					
	132	•	•	•					
	4116	•	•	•					

5837.  

rund, elastisch
round, elastic
rond, élastique

	045	060	075	090	100	120	150	180	200
	45cm	60cm	75cm	90cm	100cm	120cm	150cm	180cm	200cm
	2	3	4	5	5	6	8	10	12
	6pr.	5pr.							
	102	•	•						
	132	•	•						





584.  

Orthopädie, Schnürsenkel auf Rolle, 25m.
Orthopedie, laces on the roll, 25m.
Orthopaedics, veter op rol, 25m.
Orthopédie, bobine de lacet, 25m.



Senkelbleche
Lace hooks
Veter-ijzertjes
Ferrets pour lacets









526001 rund/round/rond/ronde
526002 Kordel/cord/koord/cordelé
526003 flach/fla/flat/plat

	10	14	29	30
	flach-fein flat-fine plat-smal plat-fin	Kordel cord koord cordelé	elastisch elastic élastique	rund-dünn round-thin rond-dun rond-fin
				
	in 14 Farben all 14 colours alle 14 kleuren toutes les 14 couleurs	•	•	•
	102	•	•	•
	132	•	•	•
	147	•	•	•

DOCKSIDE 5200.  

 1 Blister

LEDER - LEATHER - LEDER - CUIR

	00	06	03	11	01	15	05	07
	schwarz black zwart noir	weiß white wit blanc	natur naturel naturel natural	m.braun m.brown m.bruin brun moy.	d.braun d. brown d.bruin brun f.	braun/gelb brown/yell bruin/geel brun/jaune	blau blue blauw bleu	grün green groen vert
								
flach-breit flat-large plat-breed plat-large	01	120cm	6	•	•	•	•	•
rund-dünn round-thin rond-dun rond-fin	02	100cm	5	•	•	•		











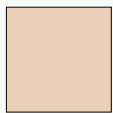

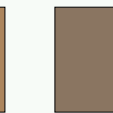

100%

Nadel für leder Schnürsenkel
Needle for leather laces
Naald lederen veters
Équille pour lacets en cuir

52000300

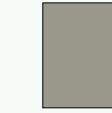
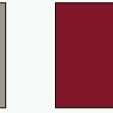
 RINGPOINT ORTHOPÄDIE

						
101	147	149	116	119	139	126
white	cream	ivory	beige	dark beige	antelope	m. brown
						
132	133	102	111	109	128	123
dark brown	very dark brown	black	dark grey	medium grey	bordeaux	dark blue



RP ORTHOPÄDIE, DISPLAY

Display
Display
Verkoopsstand
Présentoir

exkl. Produkte/products excl./
excl. producten/produits non-inclus

59918

LEDER - LEATHER - LEDER - CUIR



1p.



1. **LUXARY**
Hochwertiges Leder mit rutschfeste Latexschicht
Sheapleather with latex anti-slip
Natuurleder met mousse antislip onderlaag
Cuir véritable avec mousse de latex anti-dérapante
5105 **35>47**
2. **1/2 LUXARY**
Hochwertiges Leder mit rutschfeste Latexschicht
Sheapleather with latex anti-slip
Natuurleder met mousse antislip onderlaag
Cuir véritable avec mousse de latex anti-dérapante
5130 **35/36>41/42**
3. **ACTIF LEATHER**
Leder mit Aktivkohle
Leather with active carbon
Leder met actieve koolstof
Cuir à carbone actif
5103 **35>46**
4. **PELLE**
Leder mit Aktivkohle, rutschfest
Leather with active carbon, antislip
Leder met actieve koolstof, antislip
Cuir à carbone actif, anti-dérapant
5106 **35>47**

RINGPOINT LEADER - LEATHER - LEDER - CUIR

1p.

Hochwertiges Rindsleder mit Fersenpolster, Pflanzlich gegerbt
Cow leather of highest quality with heel cushion, tanned with vegetable extracts
Hoogwaardig koeienleer met hielkussen, gekleurd met plantenextracten
Vachette d'une qualité excellente avec coussin de talon, tanage végétal



1. Ledersohle
leather sole
lederzool
semelle cuir
54041 **36>47**
2. Lederfußbett
leather footbed
leder voetbed
voûte cuir
54042 **36>47**

ORTHOCARE



1p.



1. **ORTHOFIX**
Einlage, Damen
Arch support, women
Steunzool, dames
Semelle support, damesÀ
5125 **36>40**
2. **ORTHOFIX**
Einlage, Herren
Arch support, men
Steunzool, heren
Semelle support, hommes
5126 **40>46**
3. **WALKFIX**
4/5 Sohle mit Pelotte
4/5 sole with pad
4/5 zool met pelot
4/5 semelle avec pelotte
5127 **35>42**
4. Fersenkissen mit Lederbezug
Heelcushion with leather
Hielkussen met lederbekleding
Talonnette recouvert de cuir
5132 **1>4**
5. **PELOTTE-T**
T-Form mit Lederbezug
T-shaped with leather
Pelot T-vorm met lederbekleding
Pelotte forme T recouvert de cuir
5133 **1>4**
6. **PELOTTE**
Tropfen-Form mit Lederbezug
Drop-shaped with leather
Druppelvorm met lederbekleding
Forme-goutte recouvert de cuir
5134 **1>4**
7. **SLIPSTOP**
Rutschbremse
Slipstop
Antislip
Arrête-glisse
5131

Jede Größe
all sizes
alle maten
toutes les pointures

WINTER



1p.



1. **WOOLY**
 Dick wollige Sohle, weiß
 Deep-pile wool, white
 Hoogpolige wol, wit
 Laine à poil long, blanc
5122

35>47



2. **COSY**
 Durchgesteppte Wolle, weiß
 Stitched wool, white
 Doorstikte wol, wit
 Laine coussu, blanc
5123

37>46

ALL SEASONS

1p.



1. **ODORCARE**
 Kohlenstoff, blau durchgesteppt
 Carbon, blue stitched
 Koolstof, blauw doorstikt
 Carbone, bleu coussu
5102

35>46



2. **NATURE**
 Lederfaser (3 Paar)
 Leather fibre (3 pair)
 Ledervezel (3 paar)
 Fibre de cuir (3 paires)
5108

35>47



3. **FRESH**
 Lederfaser/Kohlenstoff
 Leather fibre/carbon
 Ledervezel/koolstof
 Fibre de cuir/carbone
5115

35>46



4. **PINE**
 Latex-Schaum
 Latex foam
 Latexschuim
 Mousse de latex
5118

35>47



5. **FABULOUS**
 Waldmoos, durchgesteppt
 Forestmoss, stitched
 Woudmos, doorstikt
 Mousse de forêt, coussu
5120

35>46



6. **IBIZA**
 Barfuß-Einlegesohle, Badestoff mit Aktivkohle
 Barefoot sole, towelling cotton with actif carbon
 Blootvoets zool, badstof met actieve koolstof
 Semelle en tissu en éponge avec carbone actif
5110

35>46



7. **BAMBOO**
 (Barfuß-Einlegesohle) Bambus + Kokos
 (Barefoot sole) bamboo + coco
 (Blootvoets zool) bamboe + kokos
 (Semelle pieds nues) bambou + coco
5109

35>47



EXTRA COMFORT®



KOMFORT EINLAGE - COMFORT INSOLES - COMFORTZOOOL - SEMELLE DE CONFORT

Sohle mit EXTRA Längsgewölbestütze und Natur-Kalbslederdecke, sehr weich gepolstert, mit Aktivkohle zur Verminderung lästigen Fußgeruchs.

Sole with extra medial support, in natural soft calfleather, very soft, with a charcoal layer for odour absorption.

Comfortzool met extra mediale steun, vervaardigd uit het zachtste natuurgeloooid kalfsleder met een anti-bacteriële, schokabsorberende koolstoflaag tegen voetgeur.

Semelle avec support plantaire extra, en cuir de veau naturel et très souple, sur une sous-couche de charbon actif neutralisant l'odeur des pieds.

Sohle mit extra Längsgewölbestütze, sehr weich gepolstert, mit stoßdämpfendem Extrafoam und Aktivkohle zur Verminderung lästigen Fußgeruchs.

Sole with extra medial support, with very shockabsorbing Extrafoam, with a charcoal layer for odour absorption.

Comfortzool met extra mediale steun, vervaardigd uit zeer schokabsorberende Extrafoam met een anti-bacteriële, vochtabsorberende koolstoflaag.

Semelle avec support plantaire extra, en Extrafoam doux et très absorbant les chocs, sur une sous-couche de charbon actif neutralisant l'odeur des pieds.

5401

35>46

5402

35>46



ALL SEASONS



1. 2. 3.



6. 7. 8.



9. 10.

- | | |
|--|----------------|
| 1. FUN & FRESH
<u>569004</u> | 36>47 |
| 2. SOFT
<u>569006</u> | 36>47 |
| 3. COMFORT
<u>569010</u> | 36>47 |
| 6. COMFORT BLACK
<u>569011</u> | 36>47 |
| 7. ODOUR STOP
<u>569012</u> | ONE SIZE 36/46 |
| 8. SPORTIVE PLUS
<u>569014</u> | 36>47 |
| 9. EXCELLENT
<u>569018</u> | 35/36>41/42 |
| 10. PURE FRESH
<u>569020</u> | 35/36>41/42 |

WINTER



12. 13. 14.



15. 16. 17.

- 12. **TWIN**
569030 36 > 46
- 13. **EXQUISIT**
569032 36 > 46
- 14. **ALU FLEECE**
569034 36 > 46
- 15. **WORKER**
569036 36 > 46
- 16. **ASTRO THERM**
569038 36 > 47
- 17. **MICROTEMP**
569040 36 > 46

SOFT GEL



18. 19.



20. 21.

- 18. **GEL ULTRAFLAT**
569050 36/37 > 44/45
- 19. **HEEL DREAM**
569054
- 20. **DISCO QUEEN**
569052
- 21. **HEEL PAD**
569055 Damen/women/dames/dames

FOOT COMFORT



25. 26. 27.



28. 29. 30.

- 25. **SOLETTE**
569060 Damen/women/dames/dames 35 > 44
- 26. **LADY COMFORT**
569062 36 > 42
- 27. **COMFORT PLUS**
569064 Damen/women/dames/dames 36 > 42
569065 Herren/men/heren/hommes 43 > 46
- 28. **ANTI SLIP**
569066
- 29. **TALON (PLUS)**
569068 35/37 > 44/46
- 30. **FOOTBED**
569074 Warm/warm/warm/chaud 36 > 46
569075 Sommer/summer/zomer/été 36 > 46

KINDER - KIDS - CHILDREN - ENFANTS



31. 32. 33. 34.

- 31. **FUN & FRESH**
569104 23/24 - 35/36
- 32. **SOFT**
569106 23/24 > 35/36
- 33. **ALU FLEECE**
569134 23/24 > 35/36
- 34. **ASTRO THERM**
569138 23/24 > 35/36

VERSCHIEDENES - VARIOUS - DIVERSE - DIVERS



1. TOT'L PROTECTION®

Imprägnierer/Waterproofing/
Waterdichtmaker/Imperméabilisant

Spezial Schutzmittel für jegliche Art von Leder, Wild- und Nubuckleder. Die regelmäßige Verwendung schützt gegen Regen-, Schnee-, Ölflecken usw.

Especially developed to protect all types of leather, suede or nubuck. Regular use protects against spots from rain, snow, oil, etc.

Speciaal ontwikkeld ter bescherming van alle producten in leder, daim en nubuck. Regelmatig gebruik voorkomt vlekken van regen, sneeuw, olie enz.

Spécial pour protéger toute sorte de cuir, de daim ou de nubuck. Lorsqu'on l'applique régulièrement, il protège contre les taches de pluie, de neige, d'huile etc.



5302400

2. COLLONIL

Stretch

1 liter
1 liter + spray



548001
548101

3. PALC SELF SHINE

Selbstglanz, topf mit Schwamm
Self shine, jar with sponge
Zelfglans-schoensmeer, pot met spons
Crème de cirage autolustrante, pot avec éponge

- 50ml neutral 5460.001
- beige 5460.002
- bordeaux 5460.014
- dark blue 5460.017
- black 5460.018
- dark brown 5460.021
- middle brown 5460.022
- light brown 5460.023
- white 5460.024



4. SAPHIR®
Teinture Française

Farbe
Dyes
Verf
Teintures

5451.

		01	03	04	05	06	08	19
		schwarz black zwart noir	l.braun l.brown l.bruin brun cl.	braun brown bruin brun	d.braun d.brown d.bruin brun f.	blau blue blauw bleu	bordeaux bordeaux bordeaux bordeaux	fauve fauve fauve fauve
05	50ml	●		●	●	●	●	
50	500ml	●		●	●	●		
60	1l	●	●	●	●			●
70	5l	●	●	●	●			



5. TENAX

Spray Farbe
Dye spray
Spuitverf
Teinture spray

5452.

			01	04	21	32
		38 Farben colors kleuren couleurs	schwarz black zwart noir	braun brown bruin brun	weiß white wit blanc	d. braun d. brown d. bruin brun f.
15	150ml	●				
40	400ml		●	●	●	●



- 01 black
- 20 dark green
- 50 gold
- 04 brown
- 21 white
- 54 pink
- 05 dark brown
- 22 karmijn red
- 55 light blue
- 06 navy blue
- 24 silver
- 63 off white
- 07 saphir blue
- 32 black-brown
- 66 violet
- 08 bordeaux
- 35 tabac
- 67 dark hazel
- 10 cognac
- 38 hazel
- 69 turquoise
- 11 red
- 41 buffel
- 70 camel
- 12 hermes red
- 42 beige-pink
- 74 framboos
- 14 grey
- 43 sky blue
- 81 birch
- 16 beige
- 44 creme
- 82 egg shell
- 18 biscuit
- 45 ivory
- 99 misty
- 19 fauve
- 48 lavendar

PFLEGEMITTEL - CARE - ONDERHOUD - ENTRETIEN



1. 2. 3. 4.

1. **PROTECTOR 3x3**, 400 ml
561005
2. **WOLY WATERSTOP**, 75 ml
5646
3. **SHOE WAX**, 250 ml
56103 Farblos/neutral/kleurloos/neutre
4. **COMBI CARE**, 300ml aerosol
56104
5. **BRILLIANT SHINE**, 250 ml
56105



5. 6. 7.

6. **SHOE STRETCH**, 75ml aerosol
56108
7. **SHOE SHINE SPONGE**
567001 Farblos/neutral/kleurloos/neutre
567009 Schwarz/black/zwart/noir
567010 Mini - Farblos/neutral/kleurloos/neutre



8. 9. 10.

8. **SPONGE**
56710
9. **SUEDE VELOURS GUM**
56711
10. **SUEDE BRUSH**
56720
11. **GLOSS BRUSH**
5672018 dunkel/dark/donker/foncé
5672019 leicht/light/licht/clair



11. 12.

12. **COMBI CLEANER**, 200 ml
56110
56111 set

PFLEGEMITTEL - CARE - ONDERHOUD - ENTRETIEN



13. 14. 15. 16.

13. **LACK MOUSSE PATENT**, 125 ml
56113
14. **SHOE FRESH**, 100 ml
56115
15. **OIL RENOVATOR**, 250 ml
56116
16. **PERFECT GEL**
5624

KREME - CREAM - SMEERPOETS - CRÈME



17. 18. 19.

17. **SUEDE VELOURS**, 250 ml
56102
7 Farben/colours/kleuren/couleurs:
001, 008, 009, 031, 032, 033, 082
18. **SHOE CREAM**, 50 ml
5620
34 Farben/colours/kleuren/couleurs:
001, 002, 008, 009, 013, 018, 026,
027, 031, 032, 033, 035, 039, 045,
072, 082, 083, 085, 088, 089, 095,
097, 098, 099, 100, 200, 204, 212,
213, 214, 216, 218, 221, 448
19. **SHOE CREAM PLUS**, 50 ml
5622
9 Farben/colours/kleuren/couleurs:
002, 009, 018, 031, 032, 033, 039,
045, 082



20. 21.

20. **FASHION LEATHER CREAM**, 75 ml
5630
25 Farben/colours/kleuren/couleurs:
001, 002, 008, 009, 013, 018, 027,
031, 032, 033, 035, 039, 045, 072,
082, 085, 089, 097, 204, 212, 213,
214, 216, 218, 448
21. **WOLY OILED LEATHER CREAM**, 75 ml
5635



Farbe: siehe Farbkarte
colour: see colour chart
kleur: zie staalkaart
couleur: voir carte de couleurs

LIQUID - LIQUID - VLOERBAAR - LIQUIDE



1

23. **BRILLIANT SHINE LIQUID**, 75 ml5640.3 Farben/colours/kleuren/couleurs:
001, 009, 03224. **WHITE LIQUID**, 75 ml564125. **UNIVERSAL CLEANER**, 75 ml564226. **SUEDE VELOURS LIQUID**, 75 ml5643.11 Farben/colours/kleuren/couleurs:
001, 006, 009, 018, 039, 045, 070,
072, 079, 082, 09627. **LACK LIQUID PATENT**, 75 ml5644001

Farblos/neutral/kleurloos/neutre

DISPLAY - DISPLAYS - VERKOOPSSTANDEN - PRÉSENTOIRS



1



47.



48.

47. **JAR DISPLAY**, 48 ex.568001

leer/empty/leeg/vide

48. **DISPLAY**568002counter: 35 x 25 x 25 cm - leer/empty/leeg/vide
holz/wooden/hout/bois
weiß/white/wit/blanc49. **DISPLAY**568006presentation: 25 x 35 x 20 cm - leer/empty/leeg/vide
holz/wooden/hout/bois
weiß/white/wit/blanc50. **ACRYL INSERTS**

leer/empty/leeg/vide

a 568003

for flacon spray, 125 ml

b 568004

for suede brush

c 568005

for Sohlen/soles/zolen/semelles

LEDERPFLEGE - LEATHER CARE - LEDERVERZORGING - ENTRETIEN DU CUIR



1

28. **CREME ESSENTIELLE**, 150 ml564829. **POLISH**, 50 ml5650.3 Farben/colours/kleuren/couleurs:
001, 009, 03330. **DUBBIN**, 100 ml5651101

Farblos/neutral/kleurloos/neutre



49.

50a.

50b.

50c.

VERSCHIEDENES - VARIOUS - DIVERSE - DIVERS



1. Schuhanzieher/Shoehorn/
Schoenlepel/Chausse-pied

15cm - Plastic 100ex. Assort. 53110100



2. 15cm - Plastic +Haken/+hook/+haak/+crochet

schwarz/black/zwart/noir 5311150
gelb/yellow/geel/jaune 5311153
grau/grey/grijs/gris 5311154
blau/blue/blauw/bleu 5311155
weiß/white/wit/blanc 5311156
grün/green/groen/vert 5311157
rot/red/rood/rouge 5311159



3. 32cm - Plastic 100ex. Assort. 53113100



4. 60cm - Plastic +Haken/+hook/+haak/+crochet

gelb/yellow/geel/jaune 5311603
blau/blue/blauw/bleu 5311605
rot/red/rood/rouge 5311609



5. **Nickle** +Haken/+hook/+haak/+crochet

15cm 5314158
40cm 5314408
50cm 5314508
70cm 5314708



6. Schuhspanner/Shoe-tree/
Schoenspanner/Tendeur

Extra

Damen/women/dames/dames 5321015
Herren/men/heren/hommes 5321025

Hawede - Holz/wood/hout/bois

36/37 - Damen/women/dames/dames 5323136
38/39 - Damen/women/dames/dames 5323138
40/41 - Damen/women/dames/dames 5323140
40/41 - Herren/men/heren/hommes 5323340
42/43 - Herren/men/heren/hommes 5323342
44/45 - Herren/men/heren/hommes 5323344
46/48 - Herren/men/heren/hommes 5323346



7. Stiefelknecht/Boot jack/
Laarzenknecht/Retire-bottes

Holz/wood/hout/bois 5325000



VERSCHIEDENES - VARIOUS - DIVERSE - DIVERS



8. Glanzschwamm/Shoe polishing sponge

Zelfglansspons/Eponge lustrante Master 5340100
Leder/leather/leder/cuir



9. Einreibbürste/Cream brush/
Insmeerborstel/Brosse à enduire

Holz/wood/hout/bois 5370100



10. Glanzbürste/Polishing brush/
Opblinkborstel/Brosse à polir

10 x 4 cm Holz/wood/hout/bois 5370210
14 x 5 cm Holz/wood/hout/bois 5370214
15 x 4,5 cm Plastik mit Griff/plastic with grip/
plastic met greep/plastique avec manche 5370250



11. Wildlederbürste/Suede brush/
Suede borstel/Brosse à daim

Kupfer/brass/koper/cuivre 5370401
Kupfer/brass/koper/cuivre + rubber 5370402



12. Crepebürste/Crepe brush/
Crepeborstel/Brosse crêpe

12 x 4 cm 5370512

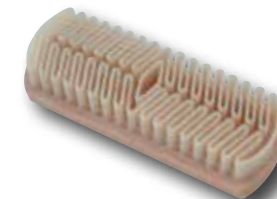

13. **BAGSTOP**

Gleitschutz für Schultertasche
Self adhesive antislip for shoulder bag
Zelfklevende antislip voor schoudertas
Anti-dérapant autocollant pour sac à bandoulière

schwarz/black/zwart/noir 40ex. 51700
d.braun/d. brown/d.bruin/brun f. 40ex. 51701
Assort. 40ex. 51709



14. **TACCOSLIP**

Fersen-Griff für geschlossene Schuhe
Heel grip for closed shoes
Hielgrip voor gesloten schoen
Grip talon pour escarpin

Karte/Display/Kaart/Carte 25ex. 51710
Dose/box/doos/boîte 50ex. 517110
schwarz/black/zwart/noir
Dose/box/doos/boîte 50ex. 517118
grau/grey/grijs/gris

Selbstklebend
Self adhesive
Zelfklevend
Autocollant



15. **TACCOSLING**

Fersen-Griff für offene Schuhe
Heel grip for open shoes
Hielgrip voor open schoen
Grip talon pour chaussures semi-ouvertes

Karte/Display/Kaart/Carte 30ex. 51720



Selbstklebend
Self adhesive
Zelfklevend
Autocollant



**BESCHLÄGE, SCHLÜSSEL UND ZUBEHÖR
METAL HARDWARE, KEYS AND ACCESSORIES
METAALWAREN, SLEUTELS EN TOEBEHOREN
QUINCAILLERIE, CLEFS ET ACCESSOIRES**

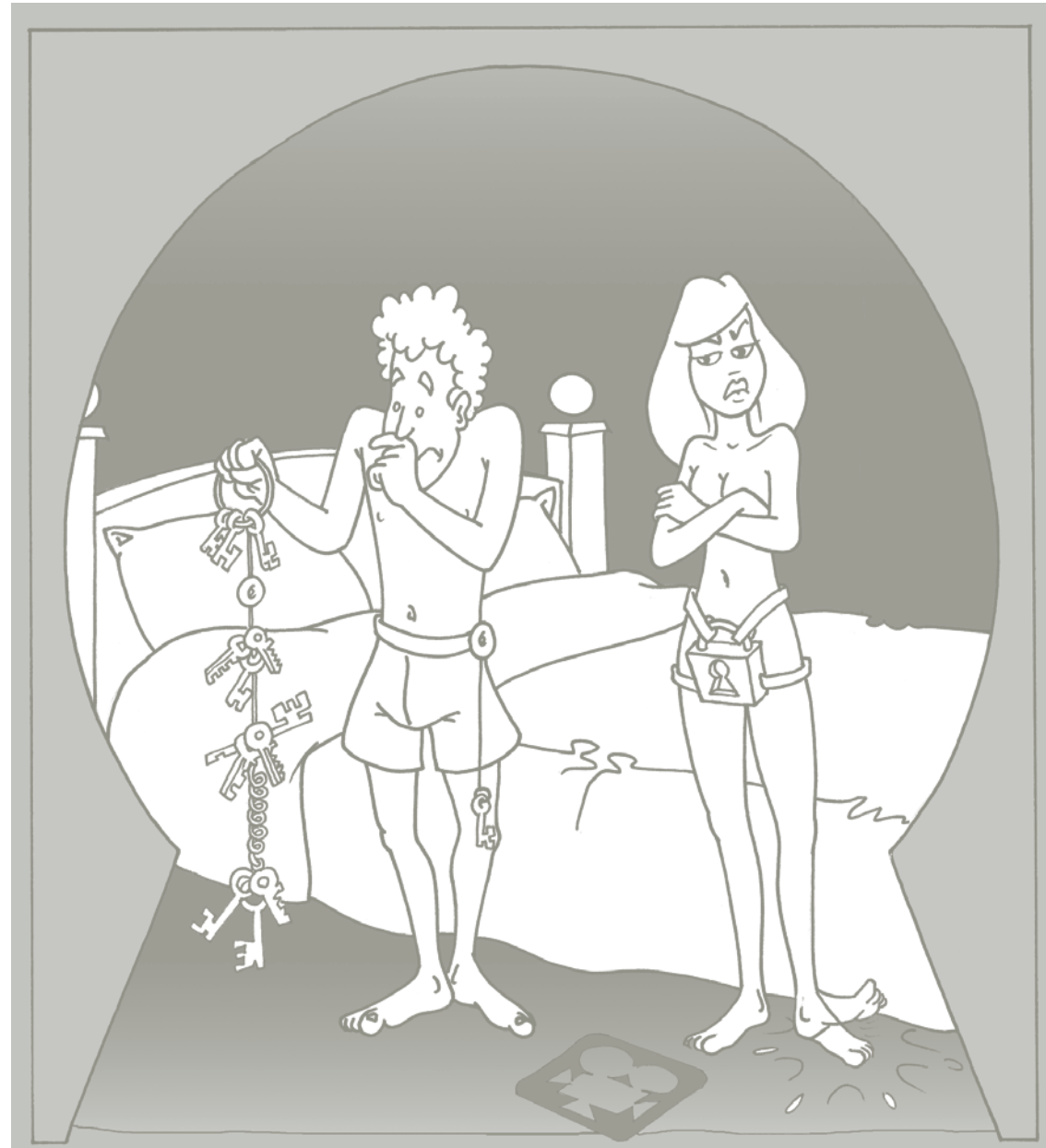

10.01	EISENWARE FÜR SHUHE SMALL METAL HARDWARE FOR SHOES METAALWAREN VOOR SCHOEISEL QUINCAILLERIE	10.2
10.02	NÄHUTENSILIEN SEWING NECESSITIES BENODIGDHEDEN VOOR NAAIMACHINE ACCESSOIRES DE COUTURE	10.8
10.03	VERSCHIEDENES (REIßVERSCHLUß, VELCRO, ...) VARIOUS (ZIPPERS, VELCRO, ...) DIVERSE (RITSEN, VELCRO, ...) DIVERS (FERMETURES ÉCLAIR, VELCRO, ...)	10.10
10.04	SCHLÜSSEL UND ZUBEHÖR KEYS AND ACCESSORIES SLEUTELS EN TOEBEHOREN CLEFS ET ACCESSOIRES	10.12
10.05	KENNZEICHEN CAR REGISTRATION PLATES AUTO-NUMMERPLATEN PLAQUES D'IMMATRICULATION	10.21

AFT®
AFT-International.com

KNÖPFE - BUTTONS - KNOPEN - BOUTONS

1. Jeansknöpfe
Jeans buttons
Jeansknopen
Boutons pour jeans

Ø	🔩	📦 50
14mm	Kupfer brass koper laiton	 42532144
14mm	Kupfer brass koper laiton	 42532147
14mm	Kupfer brass koper laiton	 42532669
14mm	Dunkelbraun dark brown donkerbruin brun foncé	 42532671
14mm	Silber silver zilver argent	 42532149
17mm	Kupfer brass koper laiton	 42531145
17mm	Kupfer brass koper laiton	 42531675
17mm	Kupfer brass koper laiton	 42531138
17mm	Kupfer brass koper laiton	 42531148
17mm	Altkupfer oldbrass oudkoper bronzé	 42531674
17mm	Nickel nickel nikkel nickelé	 42531673
17mm	Altkupfer oldbrass oudkoper bronzé	 42531049
17mm	Dunkelbraun dark brown donkerbruin brun foncé	 42531678
17mm	Graphitgrau dark grey grafietgrijs gris graphite	 42531030
17mm	Silber silver zilver argent	 42531540

2. Knöpfe, schwer (art.500)
Pushbutton, heavy (art.500)
Drukknop, zwaar (art.500)
Bouton-poussoir, lourd (art.500)

Antik/antique/antiek/antique
Nickel/nickel/nikkel/nickelé **42500**
42504



3. Nagel für Jeansknöpfe
Nails for jeans button
Nagel voor jeansknop
Clou de bouton pour jeans



42533164







4. Sortiment Jeansknöpfe, Dose 180St.
Assorted jeans buttons, box 180p.
Assortiment jeansknopen, doos 180st.
Assortiment boutons pour jeans, boîte 180p.

425300



RIVETTEN - RIVETS - RIVETTEN - RIVETS

1. Rivetten
Rivets
Rivetten
Rivets

Kopf head kop tête		Nickel nickel nikkel nickelé	Kupfer brass koper laiton	📦
2mm		6mm 4212068	4212069	100
3mm		7mm 4213078	4213079	100
3mm		9mm 4213098	4213099	100
5mm		10mm 4215108	4215109	100
5mm		12mm 4215128	4215129	100
5mm		15mm 4215158	4215159	100

2. Messingrivetten
Messing rivets
Messingrivetten
Messing rivets

Kopf head kop tête		+Nickel +nickel +nikkel +nickelé	schwarz black zwart noir	📦
3mm		9mm 4223098		500
5mm		10mm 4225108	4225100	100
5mm		12mm 4225128	4225120	100
5mm		15mm 4225158		100

3. Sortiment Rivetten, Dose 2200St.
Assorted rivets, box 2200p.
Assortiment rivetten, doos 2200st.
Assortiment rivets, boîte 2200p.

4226000



STEMPEL - DIES - EMPORTE-PIÈCE - CACHETS

1. Set
100 **650700100**
SR93/103 **650700103**
S30/105 **650700105**
106 **650700106**

2. für Knöpfe/for pushbutton
voor drukknop/pour bouton-poussoir
leicht/light/licht/léger **650700201**
Schwer/heavy/zwaar/lourd **650700202**
S14Z **650700203**

3. für Haken/for hook
voor haak/pour crochet
HK-1 **650700301**
HK-2 **650700302**
HK-3 **650700303**
491 **650700304**
510 **650700305**
515, easy-1671 **650700306**
1000, 1001 **650700307**

4. für Rivetten/for rivets
voor rivetten/pour rivets
206/S, 207/S, 209/S **650700501**
510/S, 512/S, 515/S **650700502**

5. für Senkelbleche/for lace hooks
voor veterijzertjes/pour ferrets lacets
rund-dünn/round-thin/rond-dun **650700701**
rund-dick/round-thick/rond-dik **650700702**
flach/flat/plat/plat **650700703**

6. Lochpfeifen/hole punch
holpijp/emporte-pièce trous
1,0mm **6507004010**
1,5mm **6507004015**
2,0mm **6507004020**
2,5mm **6507004025**
3,0mm **6507004030**
3,5mm **6507004035**
4,0mm **6507004040**
4,5mm **6507004045**
5,0mm **6507004050**
5,5mm **6507004055**
6,0mm **6507004060**
7,0mm **6507004070**
8,0mm **6507004080**
9,0mm **6507004090**
10,0mm **6507004100**
11,0mm **6507004110**
12,0mm **6507004120**



7. Messingamboss für Lochpfeifen
Brass anvil for hole punch
Aambeeld voor holpijp
Enclume laiton pour emporte-pièce trous **650700420**



ÖSEN+HAKEN - EYELETS+HOOKS - RINGEN+HAKEN - OEILLET+CROCHETS

1. Ösen
Eyelets
Ringen
Oeillets

100

	SR93 3mm	S30 5mm
R9005	<u>42359005</u>	<u>42369005</u>
VN	<u>42350001</u>	<u>42360001</u>
OCU	<u>42350002</u>	<u>42360002</u>
CU	<u>42350003</u>	<u>42360003</u>
A	<u>42350004</u>	<u>42360004</u>
R1019	<u>42351019</u>	<u>42361019</u>
R3007		<u>42363007</u>
R5004	<u>42355004</u>	<u>42365004</u>
R7024	<u>42357024</u>	
R8014	<u>42358014</u>	<u>42368014</u>
R8025	<u>42358025</u>	<u>42368025</u>
R8007	<u>49358007</u>	<u>42368007</u>

2. Haken
Hooks
Haken
Crochets

100

	HK-1	HK-2	HK-3
R9005	<u>426019005</u>	<u>426029005</u>	<u>426039005</u>
VN	<u>426010001</u>	<u>426020001</u>	<u>426030001</u>
OCU	<u>426010002</u>	<u>426020002</u>	<u>426030002</u>
A		<u>426020003</u>	<u>426030003</u>
R3007		<u>426023007</u>	
R5004	<u>426015004</u>	<u>426025004</u>	
R7024	<u>426017024</u>	<u>426027024</u>	
R8014	<u>426018014</u>	<u>426028014</u>	
R8007	<u>426018007</u>	<u>426028007</u>	

3. Ösen
Eyelets
Ringen
Oeillets

500

	VN	CU	R9005
3mm	<u>4231008</u>		
3mm	<u>4231038</u>	<u>4231039</u>	<u>4231030</u>
5mm	<u>4231058</u>	<u>4231059</u>	
6mm	<u>4231068</u>	<u>4231069</u>	



4. Haken (HK-515) + 2 Scheiben/2 Nieten
Hook (HK-515) + 2 discs/2 rivets
Haak (HK-515) + 2 rondellen/2 rivetten
Crochet (HK-515) + 2 rondelles/2 rivets

100

	R9005	A
HK-515	<u>426051500</u>	<u>426051502</u>



6. Easy-Roller + Scheibe/Niete
Easy-Roller + disc/rivet
Easy-Roller + rondel/rivet
Easy-Roller + rondelle/rivet

50

	R9005
	<u>42704000</u>



Für orthop. Schuhe; Schnürsenkel lassen sich einfach festbinden und lösen.
Especially for orthopaedic shoes; easy to tie up shoe or boot laces.
Voor orthopedische schoenen; makkelijk te strikken veters.
Pour chaussures orthopédiques; les lacets se nouent facilement.

5. Ösenhaken (+ Scheibe/Niete*)
Eyelet hook (+ disc/rivet*)
Ringhaak (+ rondel/rivet*)
Oeillet-crochet (+ rondelle/rivet*)

100

	R9005	A
a 491	<u>42704910</u>	<u>42704912</u>
b 510	<u>42705100</u>	<u>42705102</u>
c 1000*	<u>42710000</u>	<u>42710002</u>
d 1001*	<u>42710010</u>	<u>42710012</u>

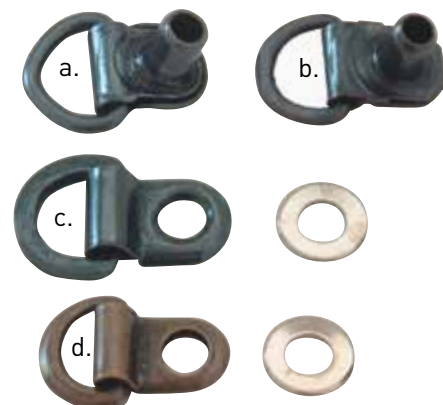

SCHNALLE - BUCKLES - GESPEN - BOUCLES



	VN	CU	R9005
10mm	<u>4110810</u>	<u>4110910</u>	
12mm	<u>4110812</u>	<u>4110912</u>	<u>4111012</u>
14mm	<u>4110814</u>	<u>4110914</u>	<u>4111014</u>
16mm	<u>4110816</u>	<u>4110916</u>	<u>4111016</u>
18mm	<u>4110818</u>	<u>4110918</u>	<u>4111018</u>
20mm	<u>4110820</u>	<u>4110920</u>	<u>4111020</u>
22mm	<u>4110822</u>	<u>4110922</u>	<u>4111022</u>
25mm	<u>4110825</u>	<u>4110925</u>	<u>4111025</u>
30mm	<u>4110830</u>	<u>4110930</u>	<u>4111030</u>



R1019	R3007	R5004	R7024	R8007	R8014	R8025	R9005
graubeige grey-beige grijs-beige gris-beige	schwarzrot bordeaux bordeaux	schwarzblau black-bleu zwartblauw noir-bleu	graphitgrau dark grey grafietgrijs gris graphite	mittelbraun med. brown middenbruin brun moyen	sepiabraun sepia brown sepiabruin brun sepia	bläßbraun dark beige donkerbeige beige foncé	schwarz black zwart noir

A	VN	OCU	CU
Antik antique antiek antique	Vernickelt nickel plated vernikkeld nickelé	Altkupfer oldbrass oudkoper bronzé	Kupfer brass koper laiton



CAMBROTALS



mod. 10 sehr lang/extra long/zeer lang/extra longue - 12cm [4407010ZL](#)



mod. 31 kurz/short/kort/courte - 10cm [4407031K](#)



mod. 31 sehr lang/extra long/zeer lang/extra longue - 12cm [4407031ZL](#)



mod. 67 klein/small/klein/petit - 9cm [4407067](#)



mod. 69 kurz/short/kort/courte - 10,5cm [4407069K](#)



nr20 für Stifte/for nails/voor nagels/pour clous [440620](#)



nr23 für Rivetten/for rivets/voor rivetten/pour rivets [440623](#)



100

Rivetten für Cambrotals
Rivets for cambrotal
Rivetten voor cambrotal
Rivets pour cambrotal
Alu. - Ø 3mm x 25mm
[4210258](#)

STIFTE - NAILS - SPIJKERS - CLOUS

1. Gestauchte stifte
Nails brad head
Spijkers 'tête homme'
Clous tête homme



1,1 x 20mm [451031120](#)
1,1 x 23mm [451031123](#)
1,1 x 25mm [451031125](#)
1,3 x 20mm [451031320](#)
1,3 x 30mm [451031330](#)



1kg.
1kg.
1kg.
1kg.
1kg.

2. Schraubnägel
Screwnails
Schroefnagels
Pointes filet roulé



1,8 x 22mm [451041822](#)

1kg.

3. Drahthandtacks
Semence nails
Semences
Semences

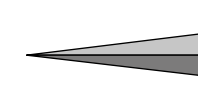

12mm [4510512](#)

1kg.

4. Trix Stahlstifte
Steel nails
Stalen spijkers
Clous en acier



12/15 [4510712155](#)
12/17 [4510712175](#)

1kg.
1kg.

5. Nagel für Nagler
Nails for pneumatic nailer
Machinenagels 'brads'
Clous pour cloueuse pneum.



15mm [6003410115](#)
20mm [6003410120](#)
25mm [6003410125](#)

box
box
box

6. Speedmaster
Speedmaster
Speedmaster
Speedmaster

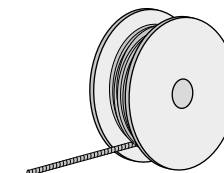

Ø 0,8mm [4510980](#) 1kg. pro Rolle

7. Kreuzschlitzschrauben
Cruciform screws
Parkervijzen
Vices cruciformes

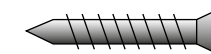

4,5 x 25mm [4409](#)

200p.

8. Kopfplatten
Metal plates
Rondellen
Rondelles

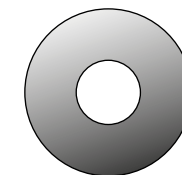

Ø22mm [4408](#)

box



NADELN - NEEDLES - NAALDEN - AIGUILLES

NR 81

10

100	6860810100
110	6860810110
120	6860810120
130	6860810130
140	6860810140



NR 332

90	6863320090
100	6863320100
110	6863320110
120	6863320120
130	6863320130
140	6863320140
160	6863320160



NR 332LL

110	6863324110
120	6863324120
130	6863324130
140	6863324140
160	6863324160



NR 332LG

100	6863325100
110	6863325110
120	6863325120
140	6863325140
160	6863325160



für Durchnämaschinen
for blackstitchingmachines
voor doornaaimachines
pour machines Blake

10

Raffl. 4002HL nr.4	68640020004
Raffl. 4002HL nr.5	68640020005
Raffl. 4002HL nr.6	68640020006
Raffl. 6021 nr.41	68660210041
Raffl. 6021 nr.45	68660210045
BT 4035 nr.5	68640350005
BT 4035 nr.6	68640350006
6002 nr.47	68660020047
HN 90/45/190 55 G1	686904519061



GARN - THREAD - GARENS - FIL À COUDRE



Seidenersatz
Sewing thread natural
Garen naturel
Fil à coudre naturels

[68410.](#)
in 11 Farben
all 11 colours
in 11 kleuren
toutes les 11 couleurs



Faden Neverstrand
thread Neverstrand
Neverstrand garen
file Neverstrand

schwarz/black/zwart/noir - 0,4 kg [68460](#)
braun/brown/bruin/brun - 0,4 kg [68461](#)
weiß/white/wit/blanc - 0,4 kg [68466](#)



NATUREL

200	197	161	106	101	100
weiß white wit blanc	sant sand zand sable	bordeaux bordeaux bordeaux bordeaux	mittelbraun medium brown middenbruin brun moyen	dunkelbraun dark brown donkerbruin brun foncé	schokoladenbraun chocolate brown chocoladebruin brun chocolat
136	183	146	172	165	
schwarz black zwart noir	dunkelgrau dark grey donkergrijs gris foncé	dunkelblau dark blue donkerblauw bleu foncé	dunkelgrün dark green donkergroen vert foncé	rot red rood rouge	

Farbabweichungen zwischen dem Farbdruck und dem Originalprodukt sind möglich.
Colour differences between print and original product are possible.
Kleurverschillen tussen het drukwerk en het origineel produkt zijn mogelijk.
Des différences de couleur entre l'imprimerie et la produit originale sont possible.



REIßVERSCHLUß - ZIPPERS - RITSEN - FERMETURES ÉCLAIR

1. Nylon
nylon
nylon
nylon

schwarz
black
zwart
noir

braun
brown
bruin
brun

8 cm	87008	87108
10 cm	87010	87110
12 cm	87012	87112
15 cm	87015	87115
18 cm	87018	87118
20 cm	87020	87120
22 cm	87022	87122
25 cm	87025	87125
28 cm	87028	87128
30 cm	87030	87130
32 cm	87032	87132
35 cm	87035	87135
38 cm	87038	87138
40 cm	87040	87140
42 cm	87042	87142
45 cm	87045	87145
50 cm	87050	87150
55 cm	87055	87155
60 cm	87060	87160
65 cm	87065	87165
70 cm	87070	87170
75 cm	87075	87175
80 cm	87080	87180
85 cm	87085	87185
90 cm	87090	87190
95 cm	87095	87195
100 cm	87099	87199



2. Metall
metal
metaal
métal

schwarz
black
zwart
noir

braun
brown
bruin
brun

8 cm	88008	88108
10 cm	88010	88110
12 cm	88012	88112
15 cm	88015	88115
18 cm	88018	88118
20 cm	88020	88120
22 cm	88022	88122
25 cm	88025	88125
28 cm	88028	88128
30 cm	88030	88130
32 cm	88032	88132
35 cm	88035	88135
38 cm	88038	88138
40 cm	88040	88140
42 cm	88042	88142
45 cm	88045	88145
50 cm	88050	88150
55 cm	88055	88155
60 cm	88060	88160
65 cm	88065	88165
70 cm	88070	88170
75 cm	88075	88175
80 cm	88080	88180
85 cm	88085	88185
90 cm	88090	88190
95 cm	88095	88195
100 cm	88099	88199



4. Prym

482120	8630120
482121	8630121
482132	8630132
482133	8630133
482138	8630138
482314	8630314
482411	8630411

[100%]



5

3. Nylon, schwer - offen
nylon, heavy - open
nylon, zwaar - open
nylon, lourd - ouverte

schwarz
black
zwart
noir

braun
brown
bruin
brun

50 cm	894050	894150
55 cm	894055	894155
60 cm	894060	894160
65 cm	894065	894165
70 cm	894070	894170
75 cm	894075	894175
80 cm	894080	894180
85 cm	894085	894185



5. pro Meter, Nylon
per metre, nylon
par mètre, nylon

schwarz/black/zwart/noir
braun/brown/bruin/brun

8600
8601

[50%]



6. Schlitten, Nylon
Fastening, nylon
Schuiver, nylon
Glissière, nylon

schwarz/black/zwart/noir
braun/brown/bruin/brun

8610
8611



7. Stopper
Stopper
Stopper
Arrêt

für oben/above/boven/dessus
für unten/below/onder/dessous

8620
8621

VERSCHIEDENES - VARIOUS - DIVERSE - DIVERS

1. Velcro

25m

black white

20mm			8506201
20mm			8506202
25mm		8500251	8506251
25mm		8500252	8506252
30mm		8500301	8506301
30mm		8500302	8506302
50mm		8500501	8506501
50mm		8500502	8506502

2. Velcro ADS

25m

Selbsthaftend/adhesive/zelfklevend/autocollant

black white

25 mm		8510251	8516251
25 mm		8510252	8516252
50 mm		8510501	8516501
50 mm		8510502	8516502



3. Reparaturretikett, Rolle 500St.

Repair label, rol 500p.
Etiket reparatie, rol 500st.
Étiquette réparation, rouleau 500p.

	NL	FR
gelb/geel/yellow/jaune	822004	822104
blau/blue/blauw/bleu	822008	822108
rot/red/rood/rouge	822009	822109
grün/green/groen/vert	822007	822107

4. Halter für Etiketten, Holz
Holder for labels, wood
Houder voor etiketten, hout
Porte-étiquettes, bois

8225

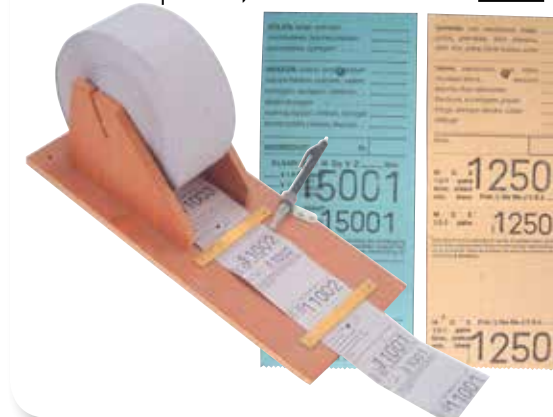

SCHLÜSSEL - KEYS - SLEUTELS - CLEFS

1. JMA
Schlüssel
keys
sleutels
Clefs
a. Normal



Für den vollständigen Programm:
For the complete program:
Voor het volledige programma:
Pour le programme détaillé :
www.jma.es

d. Bohrmulden- oder Bahnenschlüssel
Dimple and laser-keys
Boor- en langsfreesleutels
Clefs à points et fraisées



b. Ultralight: litto + universal



c. Kreuz Schlüssel/cruciform/kruisvorm/cruciformes



e. Autoschlüssel/Car keys/Autosleutels/Clefs de voiture



f. Fashion U5D - 24ex.



2. Möbelschlüssel
Furniture keys
Meubelsleutels
Clefs à meubles

Junie 483	8x6mm	40mm	Brown Messing
Junie 478	8x6mm	40mm	Nickle
Junie 383	8x6mm	40mm	Brown Messing
Junie 520	8x6mm	45mm	Brown Messing Tin
Junie 320	8x6mm	40mm	Brown Messing
Junie 339	8x6mm	40mm	Brown Messing



3. BASI co
Zylinder
Cylinder
Cilinder
Cylindre



40mm	10/30	930401030
60mm	30/30	930603030
60mm	30/30	930603030GS
65mm	30/35	930653035
70mm	30/40	930703040
70mm	35/35	930703535
75mm	30/45	930753045
75mm	35/40	930753540
80mm	40/40	930804040
knop key original	60mm 60mm	30/30 30/30
		93K603030 93KBASI

JMA SCHLÜSSELMASCHINEN - KEY MACHINES - SLEUTELMACHINES - MACHINES À CLEFS

1. Vienna	95001100
Vienna Smart	95001150
Ecco	95001200
Ecco Plus	95001250
Titan Bit	95002100
Ecco Bit	95002200
Saratoga	95002500
Capri	95003100
Capri Smart	95003150
Dakki	95003200



Für den vollständigen Programm:
For the complete program:
Voor het volledige programma:
Pour le programme détaillé :
www.jma.es

ZUBEHÖR - ACCESSORIES - TOEBEHOREN - ACCESSOIRES

1. Schlüsselring
Key-ring
Sleutelring
Anneau de clef

Regular	Ø25mm	400ex.	910010
Neon Fluo	Ø25mm	400ex.	910015
Keyring big	Ø29mm	320 ex.	910020



NEU
NEW
NIEUW
NOUVEAU



(100%)

2. Schlüsselkappe
Key cap
Sleuteldopje
Capuchon plast. de clef

Regular		400ex.	910110
Neon Fluo		400ex.	910115
Square	29x27mm	200ex.	910120
Poker design		400ex.	910130



NEU
NEW
NIEUW
NOUVEAU



(100%)

3. Schlüsselringe
Key-rings
Sleutelringen
Anneau brisés

Metal/metal/metaal/métalle			
Assort.	320ex.		910300
17mm	200ex.		910317
21mm	200ex.		910321
23mm	200ex.		910323
25mm	200ex.		910325
28mm	200ex.		910328
30mm	200ex.		910330
35mm	200ex.		910335
51mm	50ex.		910351

Kupfer/brass/koper/laiton			
17mm	200ex.		9103917
21mm	200ex.		9103921
28mm	200ex.		9103928



4. Schlüssletikette mit Ring
Key label with ring
Sleueteletiket met ring
Étiquette de clef avec anneau

Assort.	22x51mm	200ex.	910210
black	22x51mm	200ex.	910220
yellow	22x51mm	200ex.	910222
purple	22x51mm	200ex.	910227
l.blue	22x51mm	200ex.	910228
red	22x51mm	200ex.	910229



Kevron Assort.	29x57mm	96ex.	910240
----------------	---------	-------	---------------



SCHLÜSSELANHÄNGER - KEY CHAIN - SLEUTELHANGER - PORTE-CLÉS

5. 'PUSH'
Nickel/nickel/nikkel/nickelé 39x15mm 12ex. **927038**
Kupfer/brass/koper/laiton 39x15mm 12ex. **927039**

6. Clip + Kette 45 cm
Clip + chain 45 cm
Clip + ketting 45 cm
Clip + chain 45 cm

928050

7. Schlüsselkette 40 cm
Key chain 40 cm
Sleutelketting 40 cm
Porte clé, chaîne métallique 40 cm
Nickel/nickel/nikkel/nickelé 2mm 12ex. **927540**

8. Karabinerhaken
Snaphook
Musketon
Musqueton
plastic - 12ex. Assort. **926020**

9. Nickel/nickel/nikkel/nickelé - nr.1 1ex. **926001**
Nickel/nickel/nikkel/nickelé - nr.2 1ex. **926002**
Nickel/nickel/nikkel/nickelé - nr.7 1ex. **926007**

NEU
NEW
NIEUW
NOUVEAU

10. Metal Assort. 30ex. (6x5) **925630**

50%)

NEU
NEW
NIEUW
NOUVEAU

11. Berghaken mit Ring
Stretch hook with ring
Berghaak met ring
Crochet alpin avec anneau

Aluminium		
5 x 50mm	1ex.	910405
6 x 60mm	1ex.	910406
8 x 80mm	1ex.	910408

12. 'FOTO'
Acrylic 46x60mm 1ex. **922400**

13. '5 RINGS'
1ex. **925900**

14. 'BOTTLE OPENER'
1ex. **925700**

15. 'METAL + BLACK'
Acrylic 46x60mm 1ex. **925800**

Kann graviert werden
Can be engraved
Kan gegraveerd worden
Peut être gravé

16. 'FOOTBALL'
assort. 24ex. (4x6) **923024**
football 1 1ex. **923001**
football 2 1ex. **923002**
football 3 1ex. **923003**
football 4 1ex. **923004**

50%)



SCHLÜSSELANHÄNGER - KEY CHAIN - SLEUTELHANGER - PORTE-CLÉS

17. 'CHARME'

Assort. 48ex. [display NOT included!] **920848**



NEU
NEW
NIEUW
NOUVEAU

19. 'HOROSCOPE'

Assort. 48ex. [display NOT included!] **921512**



18. 'ALL STARS'

Assort. 24ex. [display NOT included!] **922924**

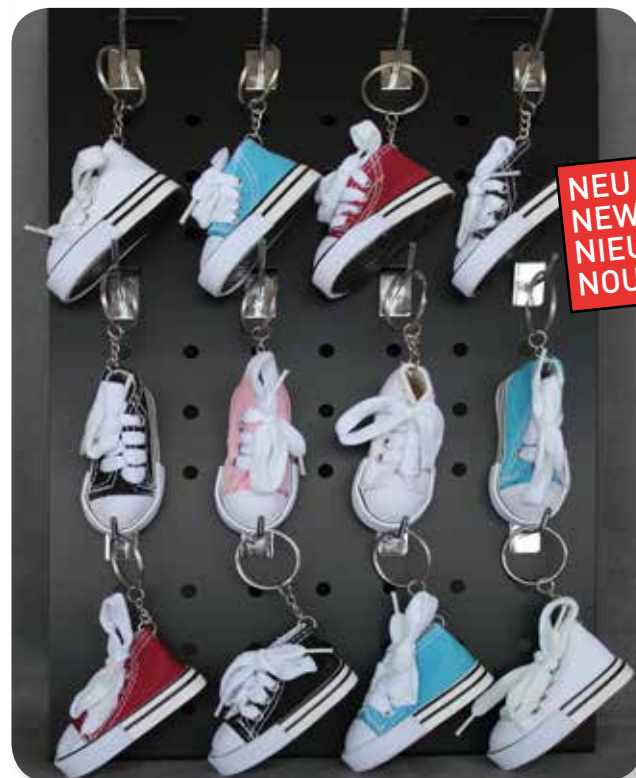

NEU
NEW
NIEUW
NOUVEAU

20. 'WHATSAPP'

Assort. 48ex. [display NOT included!] **922072**



22. 'POOLBALL'

Assort. 24ex. **922324**



(50%)

NEU
NEW
NIEUW
NOUVEAU

23. 'CUBE'

Assort. 12ex. (4x3) **922112**



(50%)

21. 'LETTER'

assort.	104ex.	[display included!]	92051104
shiny	1ex.		92051 -
shiny	26ex.		9205126
mat	1ex.		92052 -
mat	26ex.		9205226



Assortiment ohne Display
Assortiment without display
Assortiment zonder display
Assortiment sans présentoir



24. Display für Schlüsselanhänger (leer)
Display for key chains (empty)
Staander voor sleutelhangers (leeg)
Présentoir pour porte-clés (vide)

Black	12 hooks	945012
Straight	24 hooks	9450141
Round	24 hooks	9450142
Luxe	32 hooks	945032
Carton	12 hooks	945040
Floor	no hooks	945200
	hook	945201



10.04 SCHLÜSSEL UND ZUBEHÖR
KEYS AND ACCESSORIES
SLEUTELS EN TOEBEHOREN
CLEFS ET ACCESSOIRES

**NEU
NEW
NIEUW
NOUVEAU**

ZUBEHÖR - ACCESSORIES - TOEBEHOREN - ACCESSOIRES

25. Schlüsselbehälter mit Reißverschluss
Key pocket with zipper
Sleuteletui met rits
Pochet-clés avec fermeture éclair
412709 Assort. 11,5x7cm 6x1ex. **9108029**



415303 black 12x8cm 1ex. **9108030**
415303 Assort. 12x8cm 10x1ex. **9108039**



402703 black 11,5x8,5cm 1ex. **9108040**
402703 Assort. 11,5x8,5cm 10x1ex. **9108049**



26. Schlüsselbehälter
Key pocket
Sleuteletui 'klok'
Pochet-clés
410309 black 11,5x7cm 1ex. **9108010**



27. Koffer Etikett
Luggage label
Kofferlabel
Etiquette bagage
Assort. 5,5x7,5cm 48ex. **910648**

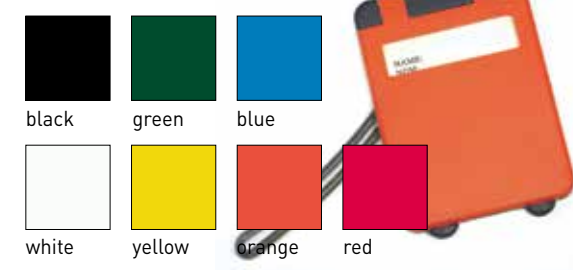

28. Koffergurtel
Luggage belt
Kofferriem
Ceinture bagage
black 1ex. **910700**
red 1ex. **910709**
rainbow 1ex. **910710**



Farben können je nach Saison variieren
Colours may vary according to the season
Kleuren kunnen per seizoen verschillen
Couleurs peuvent varier selon la saison

10.05 KENNZEICHEN
CAR REGISTRATION PLATES
AUTO NUMMERPLATEN
PLAQUES D'IMMATRICULATION

KENNZEICHEN - CAR REGISTRATION PLATES - AUTOPLATEN - PLAQUES D'IMMATR.

1. Kennzeichen Belgien
Car registration plates Belgium
Autoplaten België
Plaques d'immatriculation Belgique
7 digit zonder punt **90120**
7 digit met punt **90121**
7 digit Z-plaat groen **90127**
7 digit traktor **90128**
7 digit 4x4 - 34x21cm **90129**
7 digit 4x4 - traktor **90130**



2. Rahmen für Kennzeichen
Frame for car registration plates
Frame voor autoplaten
Cadre pour plaques d'immatriculation
Voorzijde - rood **90312**
Voorzijde - zilver **90313**

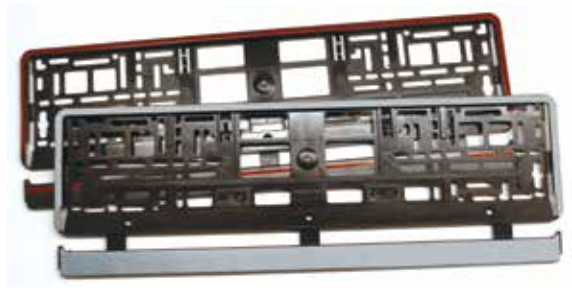

3. PRES1500 Kompleet
Kennzeichenpresse + buchstaben
Press registration plates +letters
Pers autoplaten +letters
Presse plaques d'immatriculation +caractères **90000**

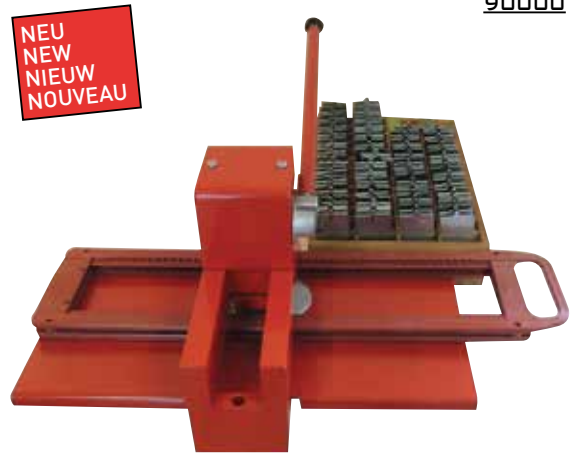

**NEU
NEW
NIEUW
NOUVEAU**

4. F85 Kompleet
Kennzeichenpresse + buchstaben
Press registration plates +letters
Pers autoplaten +letters
Presse plaques d'immatriculation +caractères **90001**

