

Product Catalog



A L P S

Table of Contents

General Product Information



Liners



Sleeves



Locks



Skin Care



A L P S

Extras



Orthotics





ALPS™ Warranty Policy

**All products are backed by a 30 day no questions asked warranty policy

LINERS	ITEM	DESCRIPTION	POLICY	
			Single	Pair
	AKDT(HD)	Extreme Locking Liner	12 Months	24 Months
	AKFR(HD)	Extreme Cushion Liner	12 Months	24 Months
	APDT-TP	Anterior Posterior Tapered Locking Liner	12 Months	24 Months
	APFR-TP	Anterior Posterior Tapered Cushion Liner	12 Months	24 Months
	ELDT	EasyLiner™ Locking Liner	12 Months	24 Months
	ELFR	EasyLiner™ Non-Locking Liner	12 Months	24 Months
	ELPX	EasyLiner™ Super Stretch	12 Months	
	EZF	EZ Flex Liner	12 Months	24 Months
	GLAK(HD)	Transfemoral Guardian Suction Liner	6 Months	
	GLBK(HD)	Transtibial Guardian Suction Liner	6 Months	
	GL	Non-Locking Silicone Liner w/o Fabric	12 Months	
	GPDT	General Purpose Locking	12 Months	24 Months
	GPFR	General Purpose Non-Locking Liner	12 Months	24 Months
	PSI	Proximal Seal Interface Liner	6 Months	12 Months
	SPDT(HD)	Superior Performance Locking Liner	12 Months	24 Months
	SPFR(HD)	Superior Performance Cushion Liner	12 Months	24 Months
	SSA	Silicone Locking Liner	12 Months	
	TFDT	Thermoliner Locking Liner	12 Months	24 Months
	TFFR	Thermoliner Non-Locking Liner	12 Months	24 Months

SLEEVES	ITEM	DESCRIPTION	POLICY	
	SFB(HD)	Superior Suction Suspension	3 Months	
	SFK	Extreme Sleeve Fabric Reinforced	3 Months	
	SFP(HD)	Superior Performance Sleeve	3 Months	
	SFR	EasySleeve Fabric Reinforced	3 Months	
	SFS	EasySleeve Fabric Reinforced, Sticky	3 Months	
	SFX	Flex Sleeve	3 Months	
	SLE	EasySleeve Super Stretch	3 Months	
	SL	Silicone Sleeve w/o Fabric	1 Month	
	SLR	Silicone Sleeve Fabric Reinforced	3 Months	
	SLR CUSTOM	Silicone Sleeve - Custom	3 Months	
	VIVA	Valve Integrated Vacuum Activated	3 Months	

LOCKS	ITEM	DESCRIPTION	POLICY	
	S498-P	Alps Lock with Pyramid	6 Months	
	S496-T	Alps Lock Flat Bottom with plate	6 Months	
	S496-W	Alps Lock Flat Bottom without plate	6 Months	

SKINCARE	ITEM	DESCRIPTION	POLICY	
	ANT-B50 / ANT-C50	Antioxidant Balm / Cream	3 Months	
	ATP008	Prosthetic Anti-Perspirant	3 Months	
	PA604	Prosthetic Lubricant	3 Months	
	PD595	Prosthetic Cleaner	3 Months	
	PO840	Prosthetic Ointment	3 Months	
	SL108	Skin Lotion	3 Months	



ALPS™ Warranty Policy

**All products are backed by a 30 day no questions asked warranty policy

EXTRAS	ITEM	DESCRIPTION	POLICY
	ENCP	Gel Sheath	1 Month
	KCN, KCM, KCW	Coolmax Sock	1 Month
	PDS	Padsil - Silicone Distal Pad	6 Months
	TSK	Protective Cosmetic Cover	6 Months

ORTHOTICS	ITEM	DESCRIPTION	POLICY
	ABS	Ankle Brace	3 Months
	BB04	Neoprene Back Support	3 Months
	BB06	Back Support	3 Months
	BB08	Lumbosacral Support	3 Months
	CFB-HP	Coolfit Knee Brace, Hinge Pull-On	3 Months
	CFB-HW	Coolfit Knee Brace, Hinge Wrap-Around	3 Months
	FIT-HP	Extended Coolfit Knee, Hinge Pull-On	3 Months
	FIT-HW	Extended Coolfit Knee, Hinge Wrap-Around	3 Months
	KBHP	Knee Brace with Hinges, Pull-On	3 Months
	KBHW	Knee Brace with Hinges, Wrap Around	3 Months
	KBP	Knee Brace w/out Hinges, Pull-On	3 Months
	KBW	Knee Brace w/out Hinges, Wrap Around	3 Months
	TB	Thumb Brace	3 Months
	WB	Wrist Brace	3 Months



ALPS South, LLC
 2895 42nd Avenue North
 St. Petersburg, Florida 33714

Tel: 727.528.8566 FAX: 727.528.8862 Email: info@easyliner.com

CAN# 6838 Form# 100405 Rev H

CLINICAL INDICATIONS

GRIPGEL LINERS

*Available in High Density (HD) Gel

Low Activity



General Purpose

GPDT/GPFR

AK and High Activity BK*



Extreme AK/BK

AKDT/AKFR

Superior*



Superior Performance

SPDT/SPFR

Gel Band Suction Suspension*



Guardian AK/BK

GLAK/GLBK

GRIPGEL SLEEVES



VIVA

VIVA

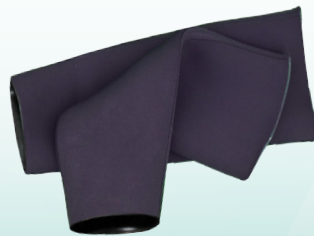

Superior Suspension*

SFB



Superior Performance*

SFP

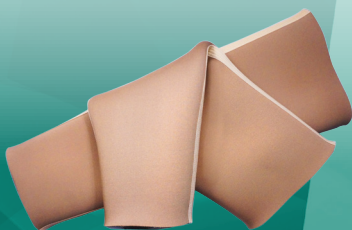

Extreme

SFK

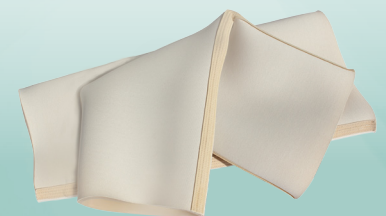

EasySleeve

SFS



CLINICAL INDICATIONS

EASYGEL LINERS

Distal Cushion



Easyliner™
ELDT/ELFR

Flexion Comfort



EZ Flex Liner
EZF

Proximal Seal



Proximal Seal Interface
PSI

Difficult Cases



Easyliner™ Super Stretch
ELPX

EASYGEL SLEEVES



Easysleeve
SFR



Easysleeve Super Stretch
SLE



Comparison of ALPS Gels



EasyGel

Soft, powdery texture

Contains antioxidants that are an effective scavenger of free radicals and hydroxyl groups

Best for use on patients with adherent scar tissue, skin irritations, sensitive skin



GripGel

Smooth, tacky texture

Tackiness helps aid in reducing bunching in the popliteal region

Best for use on patients with healthy skin tissue



High Density (HD) Gel

Dense, firm texture

Relatively firm nature of the gel provides active amputees with a great degree of control and feedback

Best for use on patients who are transitioning from silicone to gel

CALL TO REQUEST YOUR GEL SAMPLE TODAY!

HYDROXYL SCAVENGER CASE STUDY

ALPS™ EasyLiner contains an antioxidant that is an effective scavenger of free radicals and hydroxyl groups. Beneficial effects to the skin of patients have been reported. This case history has been provided as anecdotal evidence of the benefits that some patients have reported.

This patient is a severe diabetic, insulin dependent with compromised vascularization. A local hospital called in Jim McElhiney, CPO, in Nashville, TN to evaluate this patient.



These first two pictures were taken prior to the fitting by Jim McElhiney, CPO. The patient had been out of her prosthesis for three weeks and was being treated with wet and dry dressings. She was then fit with an EasyLiner (Cushion Liner), and EasySleeve (Sealing Sleeve); creating a suction suspension system.



After one week post initial fitting.



After three weeks post initial fitting.

Case history provided by: *Jim McElhiney, CPO
Nashville O & P*



CAN#6764 FORM#100640 Rev A



Tel: 727.528.8566 Tel: 800.574.5426 www.easyliner.com
info@easyliner.com

Extreme

AKDT(HD) / AKFR(HD)



*For Transfemoral and Active Transtibial Amputees –
With or Without Distal Attachment*

The ALPS™ Extreme Liner is specifically designed for transfemoral and active transtibial amputees. It is available in GripGel or HD Gel to provide maximum comfort. The Extreme Liner has 80% less vertical stretch than other ALPS gel liners, which provides more control and stability.

- Brown fabric offers limited vertical stretch to reduce movement of redundant tissue
- Wider distal end proportionate to the size of liner for ease of donning
- Slightly tacky feel reduces bunching in the popliteal region
- Offered in GripGel and HD Gel
- Available in 3mm and 6mm uniform



Locking



Cushion



GripGel



High Density (HD) Gel



Brown Fabric,
Horizontal Stretch with
Limited Vertical Stretch



US Patent No. 6,454,812



Tel: 727.528.8566 | Tel: 800.574.5426
www.easyliner.com | info@easyliner.com

Cross Section Diagram

3mm Uniform, 6mm Uniform

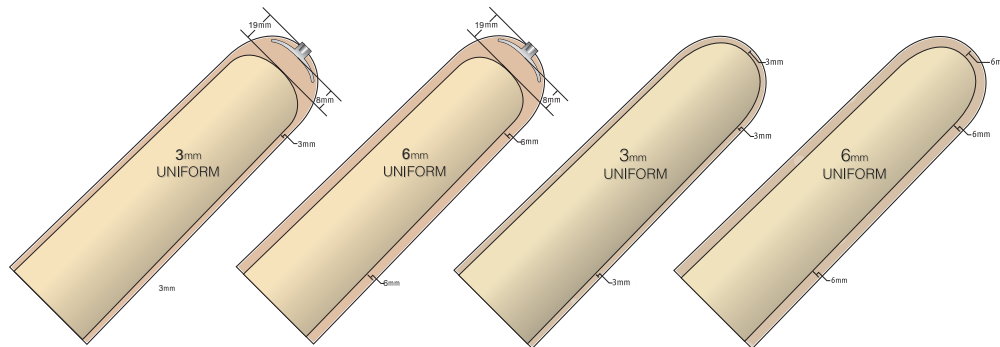

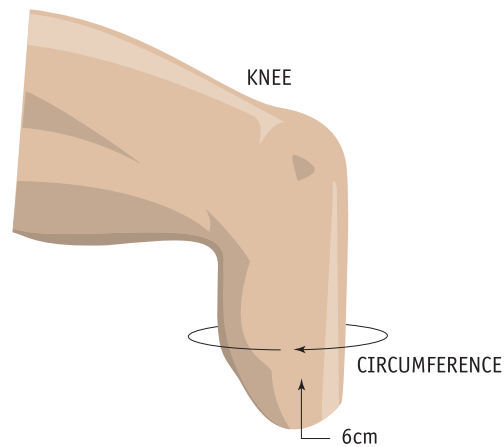

How to Size

Measurements taken 6cm from the distal end



Sizing Chart

Measured Size (cm)	 Locking 3mm or 6mm Uniform		 Cushion 3mm or 6mm Uniform	
	16-19 cm	AKDT(HD) 16 - (3 or 6)		AKFR(HD) 16 - (3 or 6)
20-23 cm	AKDT(HD) 20 - (3 or 6)		AKFR(HD) 20 - (3 or 6)	
24-25 cm	AKDT(HD) 24 - (3 or 6)		AKFR(HD) 24 - (3 or 6)	
26-27 cm	AKDT(HD) 26 - (3 or 6)		AKFR(HD) 26 - (3 or 6)	
28-31 cm	AKDT(HD) 28 - (3 or 6)		AKFR(HD) 28 - (3 or 6)	
32-37 cm	AKDT(HD) 32 - (3 or 6)		AKFR(HD) 32 - (3 or 6)	
38-43 cm	AKDT(HD) 38 - (3 or 6)		AKFR(HD) 38 - (3 or 6)	
44-53 cm	AKDT(HD) 44 - (3 or 6)		AKFR(HD) 44 - (3 or 6)	

Anterior Posterior Tapered

APDT-TP / APFR-TP



Gel Liner – With or Without Distal Attachment

The ALPS™ AP Tapered Liner is gradually tapered from the anterior to the posterior to provide superior comfort. This liner is available in a pin and lock system or suction suspension. The AP Tapered Liner features our black high performance fabric with gel to assist in reducing bunching in the popliteal region.



Locking



Cushion



Black Fabric,
Horizontal Stretch with
Limited Vertical Stretch

- Tapered - 6mm Anterior to 3mm Posterior
- Reduces bunching in the popliteal region
- High performance black fabric



US Patent No. 6,454,812



Tel: 727.528.8566 | Tel: 800.574.5426
www.easyliner.com | info@easyliner.com

Cross Section Diagram

6mm to 3mm Tapered

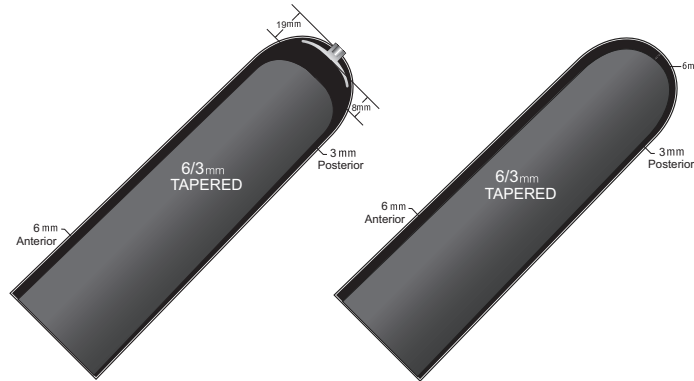

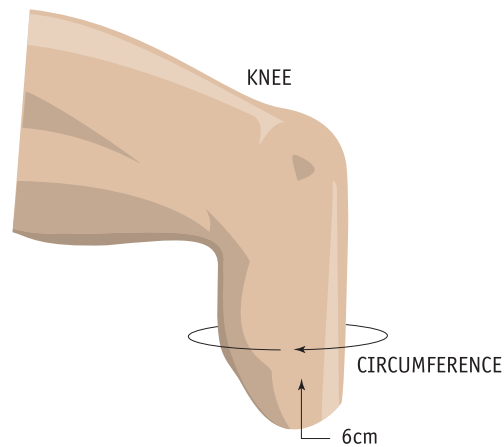

How to Size

Measurements taken 6cm from the distal end



Sizing Chart

Measured Size (cm)		
	Locking 6mm to 3mm Tapered	Cushion 6mm to 3mm Tapered
20-23 cm	APDT20 - TP	APFR20 - TP
24-25 cm	APDT24 - TP	APFR24 - TP
26-27 cm	APDT26 - TP	APFR26 - TP
28-31 cm	APDT28 - TP	APFR28 - TP
32-37 cm	APDT32 - TP	APFR32 - TP

General Purpose

GPDT / GPFR



Gel Liner, Reinforced – With or Without Distal Attachment

The General Purpose Gel Liner is generally designed for low activity amputees. It is available in our ALPS™ GripGel to provide comfort, strength, and elasticity. The superior elongation from this liner does not restrict blood flow in a patient's limb and is easy for a patient to don and doff.

- High performance fabric improves durability
- Slightly tacky feel reduces bunching in the popliteal region
- Available in 3mm and 6mm uniform



Locking



Cushion



GripGel



Beige Fabric,
Horizontal and
Vertical Stretch



US Patent No. 6,454,812



Tel: 727.528.8566 | Tel: 800.574.5426
www.easyliner.com | info@easyliner.com

Cross Section Diagram

3mm Uniform, 6mm Uniform

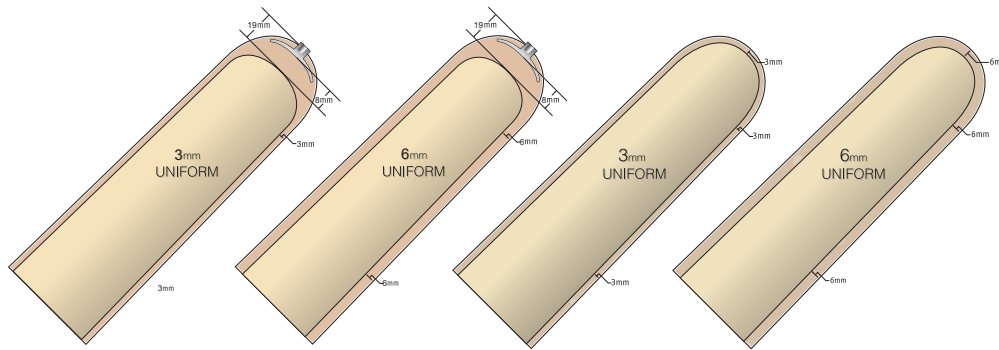

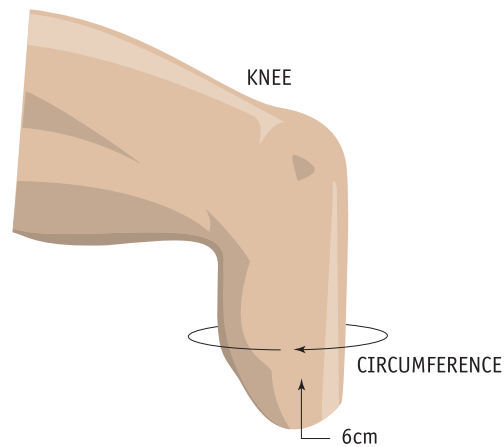

How to Size

Measurements taken 6cm from the distal end



Sizing Chart

Measured Size (cm)	 Locking 3mm or 6mm Uniform		 Cushion 3mm or 6mm Uniform	
	16-19 cm	GPDT16 - (3 or 6)		GPFR16 - (3 or 6)
20-23 cm	GPDT20 - (3 or 6)		GPFR20 - (3 or 6)	
24-25 cm	GPDT24 - (3 or 6)		GPFR24 - (3 or 6)	
26-27 cm	GPDT26 - (3 or 6)		GPFR26 - (3 or 6)	
28-31 cm	GPDT28 - (3 or 6)		GPFR28 - (3 or 6)	
32-37 cm	GPDT32 - (3 or 6)		GPFR32 - (3 or 6)	
38-43 cm	GPDT38 - (3 or 6)		GPFR38 - (3 or 6)	
44-53 cm	GPDT44 - (3 or 6)		GPFR44 - (3 or 6)	

EasyLiner™

ELDT / ELFR



Gel Liner, Reinforced – With or Without Distal Attachment

ALPS™ EasyLiner is formulated with EasyGel which contains an antioxidant that is an effective hydroxyl scavenger and has been reported to have beneficial effects to the skin. Refer to the Hydroxyl Scavenger Case Study in the general section for anecdotal evidence of the benefits.

- Reinforced seams improves durability and appearance
- Flat encapsulation provides additional comfort
- High performance fabric to improve durability
- Available in 3mm and 6mm uniform, and tapered from 6mm at distal end to 3mm



Locking



Cushion



EasyGel



Beige Fabric,
Horizontal and
Vertical Stretch



Covered by one or more of the following US Patent No.
6,454,812 7,709,570



Tel: 727.528.8566 | Tel: 800.574.5426
www.easyliner.com | info@easyliner.com

Cross Section Diagram

3mm Uniform, 6mm Uniform, 6/3mm Uniform

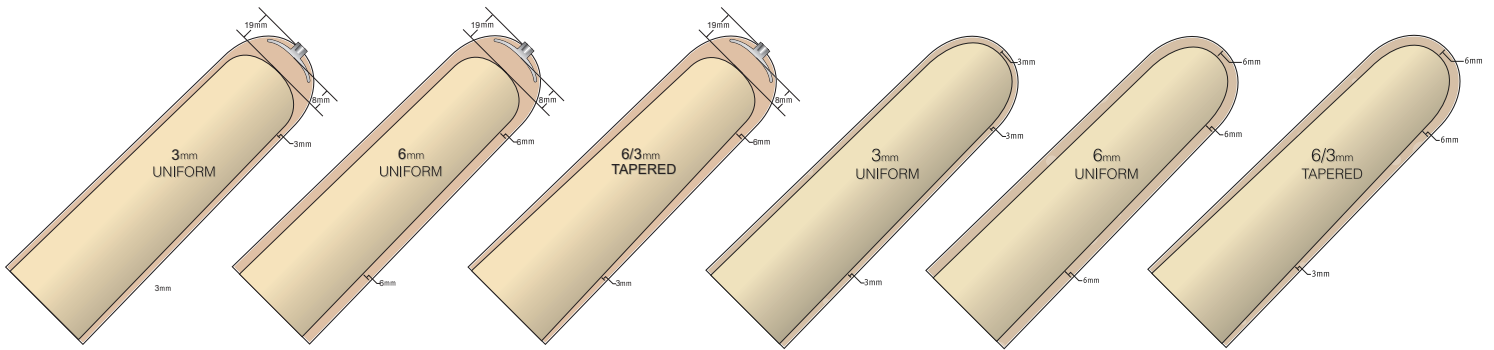

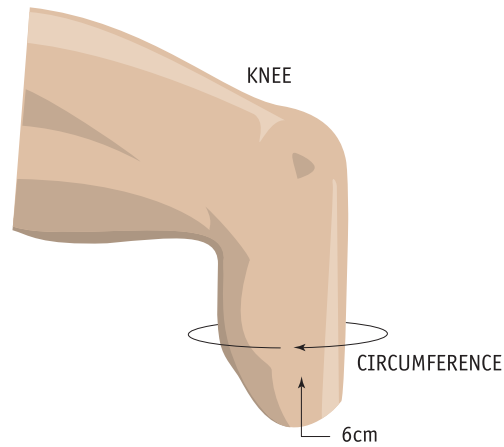

How to Size

Measurements taken 6cm from the distal end



Sizing Chart

Measured Size (cm)				
	Locking 3mm, 6mm or 6/3mm Tapered		Cushion 3mm, 6mm or 6/3mm Tapered	
16-19 cm	ELDT16 - (3, 6, or 6/3)		ELFR16 - (3, 6, or 6/3)	
20-23 cm	ELDT20 - (3, 6, or 6/3)		ELFR20 - (3, 6, or 6/3)	
24-25 cm	ELDT24 - (3, 6, or 6/3)		ELFR24 - (3, 6, or 6/3)	
26-27 cm	ELDT26 - (3, 6, or 6/3)		ELFR26 - (3, 6, or 6/3)	
28-31 cm	ELDT28 - (3, 6, or 6/3)		ELFR28 - (3, 6, or 6/3)	
32-37 cm	ELDT32 - (3, 6, or 6/3)		ELFR32 - (3, 6, or 6/3)	
38-43 cm	ELDT38 - (3, 6, or 6/3)		ELFR38 - (3, 6, or 6/3)	
44-53 cm	ELDT44 - (3, 6, or 6/3)		ELFR44 - (3, 6, or 6/3)	

EasyLiner™ Super Stretch

ELPX



Gel Liner, No Fabric – Without Distal Attachment

ALPS™ EasyLiner Super Stretch is made with EasyGel which is soft, durable and has high elasticity. The ELPX allows for complete freedom of movement without the fabric. The liner also takes advantage of the lower coefficient of friction found only with the EasyGel, enabling the skin to be relieved of shear forces.



Cushion



EasyGel



No Fabric

- Custom fit without the cost or inconvenience
- May be beneficial for patients with scar tissue
- Can fit most users
- Available only in 6mm uniform thickness



US Patent No. 7,709,570



Tel: 727.528.8566 | Tel: 800.574.5426
www.easyliner.com | info@easyliner.com

Cross Section Diagram

6mm Uniform

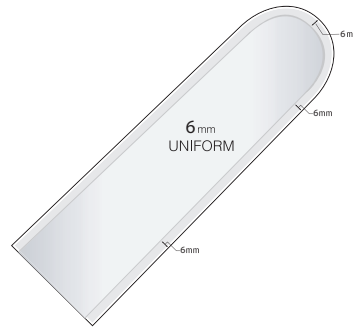

How to Size

Measurements taken 6cm from the distal end

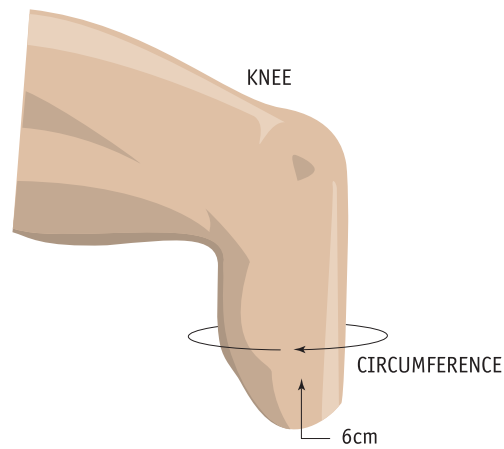

Sizing Chart

Measured Size (cm)	 Cushion 6mm Uniform
10-15 cm	ELPX-10
16-19 cm	ELPX-16
20-23 cm	ELPX-20
24-25 cm	ELPX-24
26-27 cm	ELPX-26
28-31 cm	ELPX-28
32-37 cm	ELPX-32

ALPS South, LLC 2895 42nd Avenue North
St. Petersburg, Florida 33714

Tel: 727.528.8566 FAX: 727.528.8862 Email: info@easyliner.com

EZ Flex

EZF



Gel Liner – With Two Types of Fabric

ALPS™ EZ Flex Liner allows users ease of knee flexion through an unlimited restriction of anterior stretch. The fabric has 80% less posterior vertical stretch which reduces the bunching in the popliteal region. The EZ Flex is made with EasyGel that contains antioxidants that may help promote skin health, which also provides comfort and durability.



Locking



EasyGel



Beige Fabric,
Horizontal and
Vertical Stretch



Brown Fabric,
Horizontal Stretch with
Limited Vertical Stretch

- Wider distal end that is proportionate to the size of liner for ease of donning
- Allows for more anterior stretch
- Users are able to sit for extended periods
- May be beneficial for patients with scar tissue
- Available in 3mm and 6mm uniform



Covered by one or more of the following US Patent No.
6,454,812 7,709,570 8,226,732
8,246,694 8,349,021



Tel: 727.528.8566 | Tel: 800.574.5426
www.easyliner.com | info@easyliner.com

Cross Section Diagram

3mm Uniform, 6 Uniform

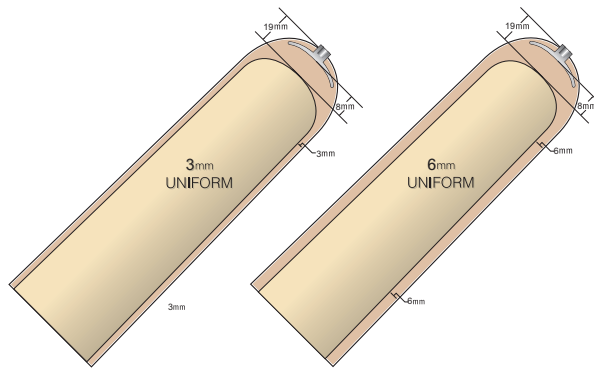

How to Size

Measurements taken 6cm from the distal end

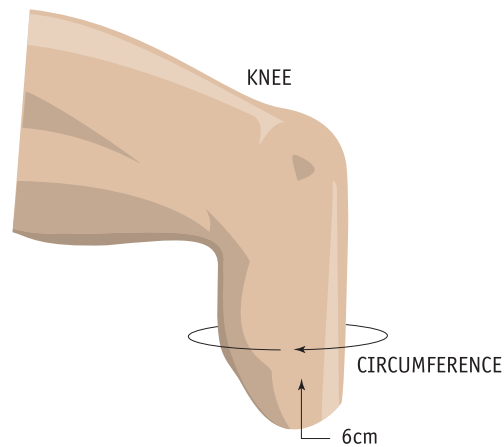

Sizing Chart

Measured Size (cm)	 Locking 3mm or 6mm Uniform
16-19 cm	EZF16 - (3 or 6)
20-23 cm	EZF20 - (3 or 6)
24-25 cm	EZF24 - (3 or 6)
26-27 cm	EZF26 - (3 or 6)
28-31 cm	EZF28 - (3 or 6)
32-37 cm	EZF32 - (3 or 6)
38-43 cm	EZF38 - (3 or 6)
44-53 cm	EZF44 - (3 or 6)

Proximal Seal Interface

PSI



Gel Liner, Distal Fabric – Without Distal Attachment



Cushion



EasyGel

ALPS™ PSI Liner is formulated with EasyGel and provides comfort, strength, and elasticity for a variety of amputees. The PSI can be used in conjunction with most valve suction or vacuum systems used in the market today. The fabric cover, located distally, allows the air to wick out of the prosthesis. This allows a sleeve to seal on the liner just proximal to the trim lines of a transtibial socket.

- Exposed gel portion allows for means of sealing
- Fabric located distally to act as air wick
- Unlimited restriction of stretch of the proximal portion of the liner
- Available in 6mm uniform and tapered from 6mm at distal end to 3mm



Made in the USA



Covered by one or more of the following US Patent No.
7,709,570 8,357,206 8,394,150



Tel: 727.528.8566 | Tel: 800.574.5426
www.easyliner.com | info@easyliner.com

Cross Section Diagram

6mm Uniform, 6/3mm Tapered

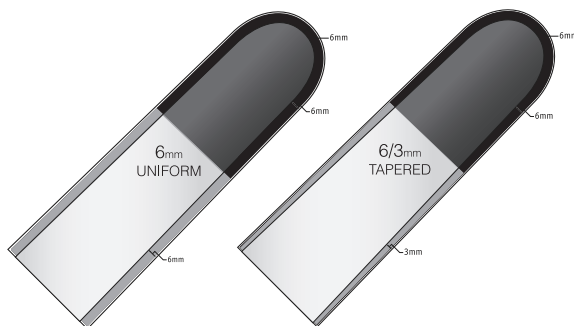

How to Size

Measurements taken 6cm from the distal end

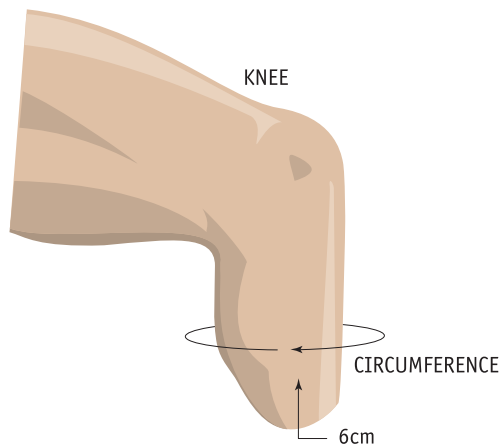

Sizing Chart

Measured Size (cm)	 Cushion 6mm Uniform or 6/3mm Tapered
16-19 cm	PSI 16 - (6 or 6/3)
20-23 cm	PSI 20 - (6 or 6/3)
24-25 cm	PSI 24 - (6 or 6/3)
26-27 cm	PSI 26 - (6 or 6/3)
28-31 cm	PSI 28 - (6 or 6/3)
32-37 cm	PSI 32 - (6 or 6/3)
38-43 cm	PSI 38 - (6 or 6/3)
44-53 cm	PSI 44 - (6 or 6/3)

ALPS South, LLC
 2895 42nd Avenue North
 St. Petersburg, Florida 33714

Tel: 727.528.8566 FAX: 727.528.8862 Email: info@easyliner.com

Guardian

GLAK(HD) / GLBK(HD)



Transfemoral (AK) rings begin 5 1/2 inches from the center of the distal end.

Transtibial (BK) rings begin 3 1/2 inches from the center of the distal end.



Cushion



GripGel



High Density (HD) Gel



Black Fabric,
Horizontal and
Vertical Limited Stretch

Gel Liner, Reinforced with Gel Bands – No Distal Attachment

The ALPS™ Guardian Suction Liner features raised bands that grip the socket wall to form a secure interface between the socket and the liner. Low modulus bands stretch against the socket wall, while the smooth inner wall conforms easily to the residual limb, to ensure there is no restriction of blood flow or stiffening to inhibit donning.

- Available with GripGel and HD Gel
- Full length inversion for ease of donning
- No reinforced seams, single piece construction that still ensures durability
- Available in 3mm and 6mm uniform

Use the Skin Reliever (ENCP) with the Guardian Liner to compensate for volume fluctuations with continued use of same socket.



US Patent No. 8,852,291



Tel: 727.528.8566 | Tel: 800.574.5426
www.easyliner.com | info@easyliner.com

Cross Section Diagram

3mm Uniform, 6 Uniform

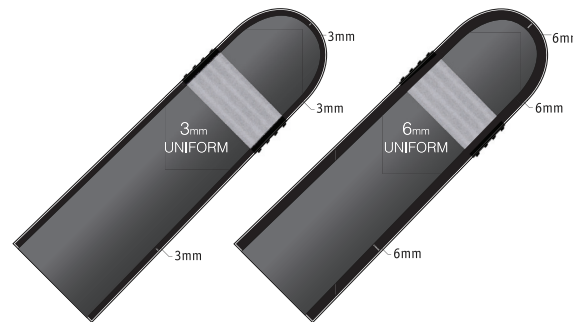

How to Size

Measurements taken 6cm from the distal end

Transfemoral Guardian Suction Cushion Gel Liner

Measured Size (cm) Description	GLAK 3mm Uniform	GLAK 6mm Uniform
26-27 cm	GLAK(HD) 26-3	GLAK(HD) 26-6
28-31 cm	GLAK(HD) 28-3	GLAK(HD) 28-6
32-37 cm	GLAK(HD) 32-3	GLAK(HD) 32-6
38-43 cm	GLAK(HD) 38-3	GLAK(HD) 38-6

Transtibial Guardian Suction Cushion Gel Liner

Measured Size (cm) Description	GLBK 3mm Uniform	GLBK 6mm Uniform
16-19 cm	GLBK(HD) 16-3	GLBK(HD) 16-6
20-23 cm	GLBK(HD) 20-3	GLBK(HD) 20-6
24-25 cm	GLBK(HD) 24-3	GLBK(HD) 24-6
26-27 cm	GLBK(HD) 26-3	GLBK(HD) 26-6
28-31 cm	GLBK(HD) 28-3	GLBK(HD) 28-6

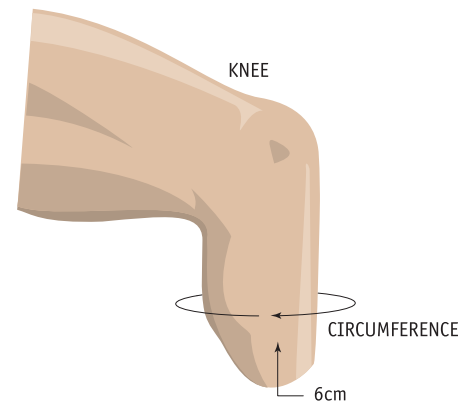

Skin Reliever (ENCP) Sizing Chart

Measurements taken 6cm from the distal end



Use the Skin Reliever (ENCP) with the Guardian Liner to compensate for volume fluctuations with continued use of same socket.

Measured Size (cm) Description	ENCP Tapered 3mm-1.5mm
10-19 cm	ENCP- 16
20-27 cm	ENCP- 20
28-31 cm	ENCP- 28

Superior Performance

SPDT (HD) / SPFR (HD)



Gel Liner, Reinforced – With or Without Distal Attachment

The ALPS™ Superior Performance Liner is ideal for active patients and provides superior comfort with ALPS GripGel or HD Gel. The SP Liner features a NEW black fabric that allows for additional comfort and stability.

- Black high performance fabric
- Offered with GripGel or HD Gel
- Available in 3mm and 6mm uniform



Locking



Cushion



GripGel



High Density (HD) Gel



Black Fabric,
Horizontal Stretch with
Limited Vertical Stretch



US Patent No. 6,454,812



Tel: 727.528.8566 | Tel: 800.574.5426
www.easyliner.com | info@easyliner.com

Cross Section Diagram

3mm Uniform, 6mm Uniform

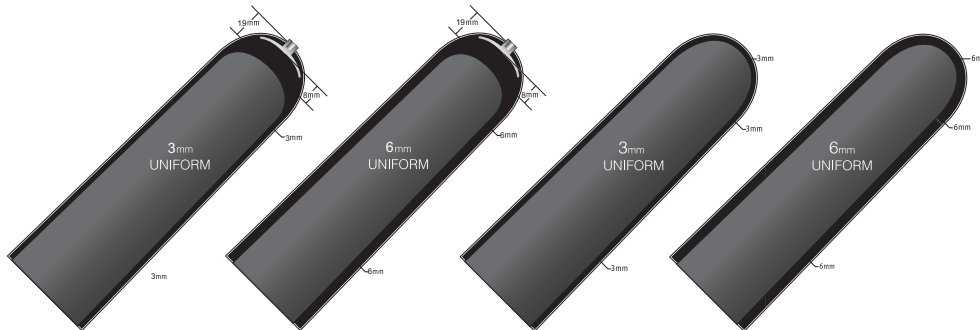

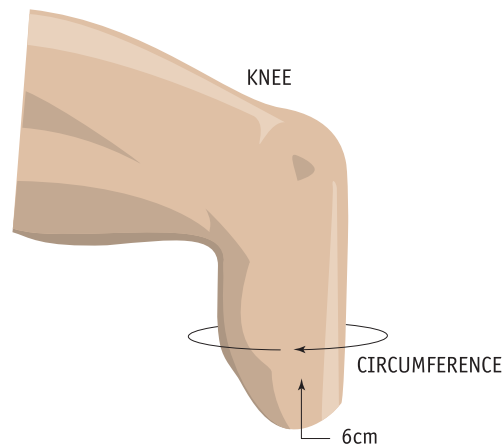

How to Size

Measurements taken 6cm from the distal end



Sizing Chart

Measured Size (cm)	 Locking 3mm or 6mm Uniform		 Cushion 3mm or 6mm Uniform	
	16-19 cm	SPDT(HD) 16 - (3 or 6)		SPFR(HD) 16 - (3 or 6)
20-23 cm	SPDT(HD) 20 - (3 or 6)		SPFR(HD) 20 - (3 or 6)	
24-25 cm	SPDT(HD) 24 - (3 or 6)		SPFR(HD) 24 - (3 or 6)	
26-27 cm	SPDT(HD) 26 - (3 or 6)		SPFR(HD) 26 - (3 or 6)	
28-31 cm	SPDT(HD) 28 - (3 or 6)		SPFR(HD) 28 - (3 or 6)	
32-37 cm	SPDT(HD) 32 - (3 or 6)		SPFR(HD) 32 - (3 or 6)	
38-43 cm	SPDT(HD) 38 - (3 or 6)		SPFR(HD) 38 - (3 or 6)	
44-53 cm	SPDT(HD) 44 - (3 or 6)		SPFR(HD) 44 - (3 or 6)	

Valve Integrated Vacuum Activated

VIVA



Gel Suction Suspension Sleeve



GripGel



Beige Fabric,
Horizontal & Vertical Stretch

ALPS™ VIVA Sleeve is made with GripGel and has a built-in valve to evacuate air in the socket to provide superior security. It provides suction suspension without the need of creating a valve in the socket. Once the sleeve is donned, the valve should be located proximal to the patella to create back pressure with knee flexion.

- Built in valve
- Minimizes compression and irritation proximally
- Freedom of knee flexion
- Available in 3mm and 6mm thickness



US Patent No. 6,361,568



Tel: 727.528.8566 | Tel: 800.574.5426
www.easyliner.com | info@easyliner.com

VIVA Cross Section Diagram

3mm Uniform, 6mm Uniform

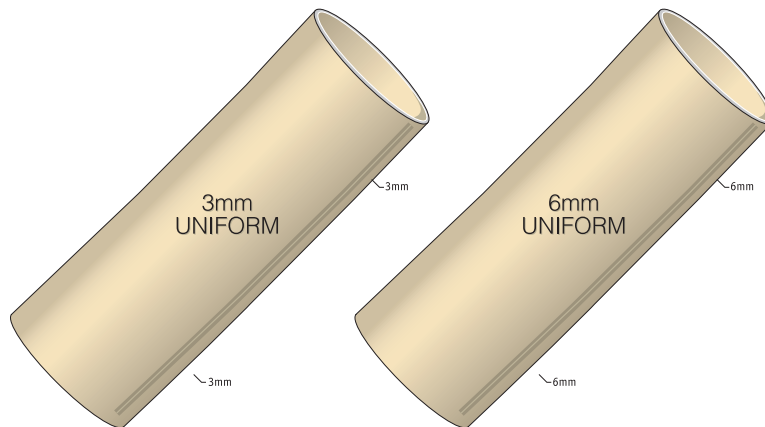

How to Size

Measurements taken 10cm above the patella

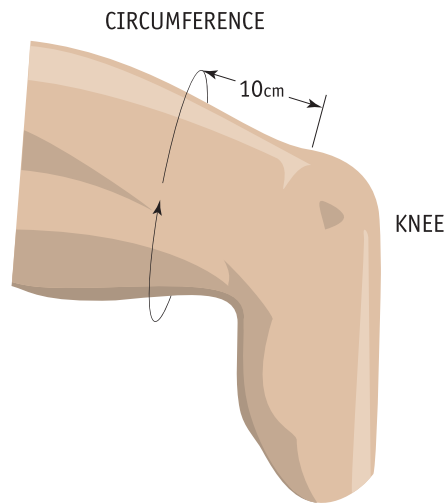

VIVA Gel Sleeve Sizing Chart

Measured Size (cm)	3mm or 6mm Uniform
20-24 cm	VIVA16 - (3 or 6)
25-30 cm	VIVA20 - (3 or 6)
31-34 cm	VIVA24 - (3 or 6)
35-37 cm	VIVA26 - (3 or 6)
38-40 cm	VIVA28 - (3 or 6)
41-45 cm	VIVA32 - (3 or 6)

Extreme

SFK

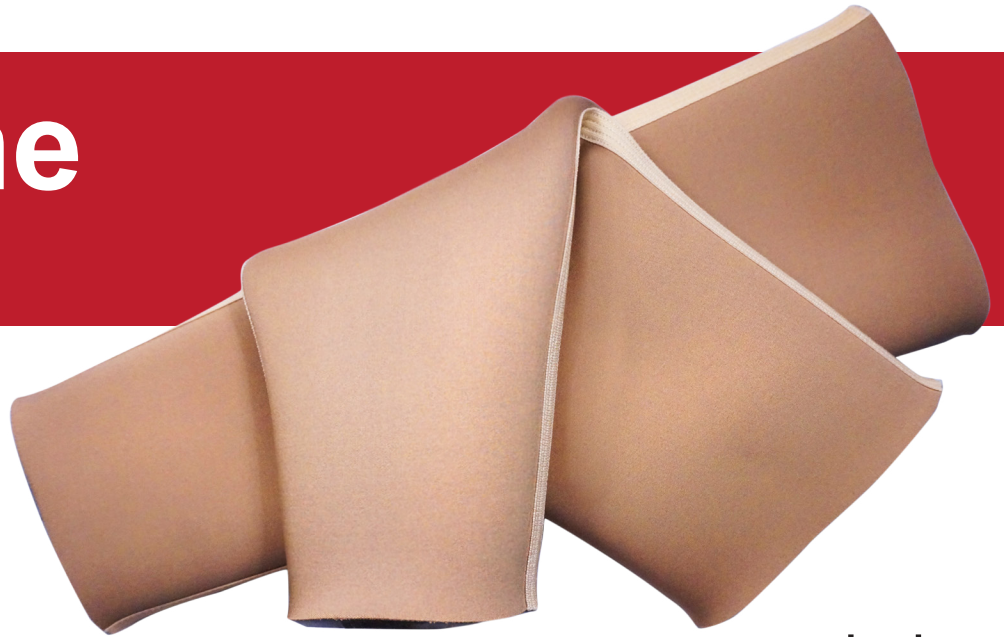

Gel Suction Suspension Sleeve - With Fabric

ALPS™ Extreme Sleeve, made with GripGel, has limited vertical stretch, while the elasticity of the fabric allows the user excellent freedom of knee flexion. The Extreme sleeve also achieves secure suspension by sealing with the skin without restricting circulation.



GripGel



Brown Fabric,
Horizontal Stretch with
Limited Vertical Stretch

- Limited vertical stretch reduces movement of redundant tissue
- GripGel provides a tacky and secure fit
- Available in 3mm and 6mm uniform thickness



Tel: 727.528.8566 | Tel: 800.574.5426
www.easyliner.com | info@easyliner.com

Cross Section Diagram

3mm Uniform, 6mm Uniform

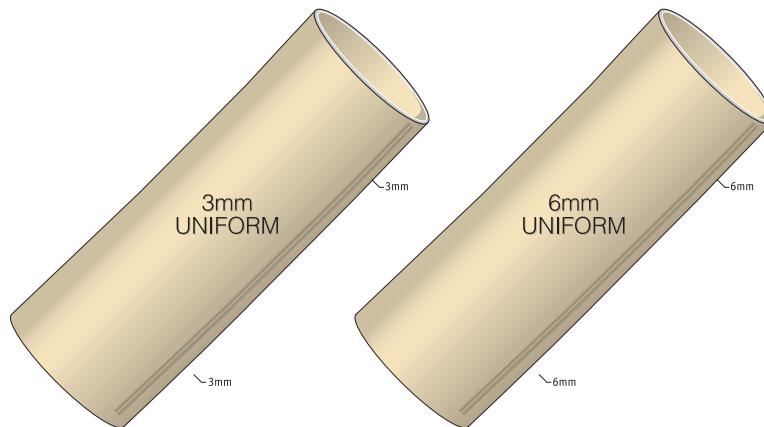

How to Size

Measurements taken 10cm above the patella

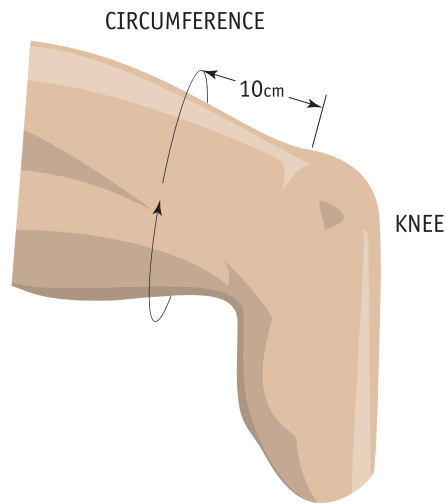

Sizing Chart

Measured Size (cm)	3mm or 6 mm Uniform
20-24 cm	SFK16 - (3 or 6)
25-30 cm	SFK20 - (3 or 6)
31-34 cm	SFK24 - (3 or 6)
35-37 cm	SFK26 - (3 or 6)
38-40 cm	SFK28 - (3 or 6)
41-45 cm	SFK32 - (3 or 6)
46-60 cm	SFK38 - (3 or 6)
61-70 cm	SFK44 - (3 or 6)

Superior Suspension

SFB(HD)



Gel Suction Suspension Sleeve

ALPS™ Superior Suspension Sleeve made with GripGel or HD Gel, features a black fabric which allows the user excellent freedom of knee flexion. The SFB achieves secure suspension by sealing with the skin without restricting circulation or causing shear forces. The thinner profile of the SFB makes it an ideal choice for those concerned about bulk.



GripGel



High Density (HD) Gel



Black Fabric,
Horizontal Stretch with
Limited Vertical Stretch

- GripGel provides a tacky and secure fit
- HD Gel provides active amputees a great degree of control
- Available in 2mm uniform thickness



Tel: 727.528.8566 | Tel: 800.574.5426
www.easyliner.com | info@easyliner.com

Cross Section Diagram

2mm Uniform



How to Size

CIRCUMFERENCE

Measurements taken 10cm above the patella

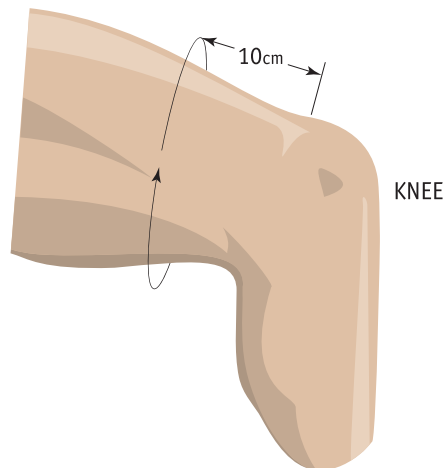

Sizing Chart

Measured Size (cm)	2mm Uniform
25-30 cm	SFB(HD) 20-2
31-34 cm	SFB(HD) 24-2
35-37 cm	SFB(HD) 26-2
38-40 cm	SFB(HD) 28-2
41-45 cm	SFB(HD) 32-2

Superior Performance

SFP(HD)



Gel Suction Suspension Sleeve

ALPS™ Superior Performance Sleeve is constructed with black fabric with GripGel or HD Gel. The black fabric has reduced stretch to provide a secure suspension without causing shear force to the patients skin.



GripGel



High Density (HD) Gel



Black Fabric,
Horizontal Stretch with
Limited Vertical Stretch

- GripGel provides a tacky and secure fit
- HD Gel provides active amputees a great degree of control
- Available in 3mm and 6mm uniform thickness



Tel: 727.528.8566 | Tel: 800.574.5426
www.easyliner.com | info@easyliner.com

Cross Section Diagram

3mm Uniform, 6mm Uniform

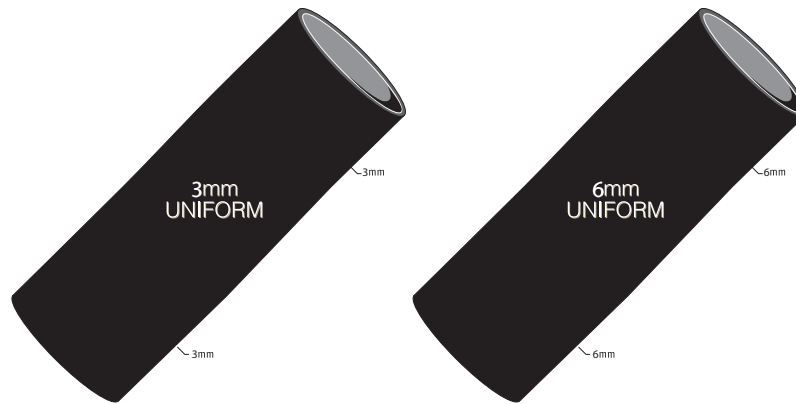

How to Size

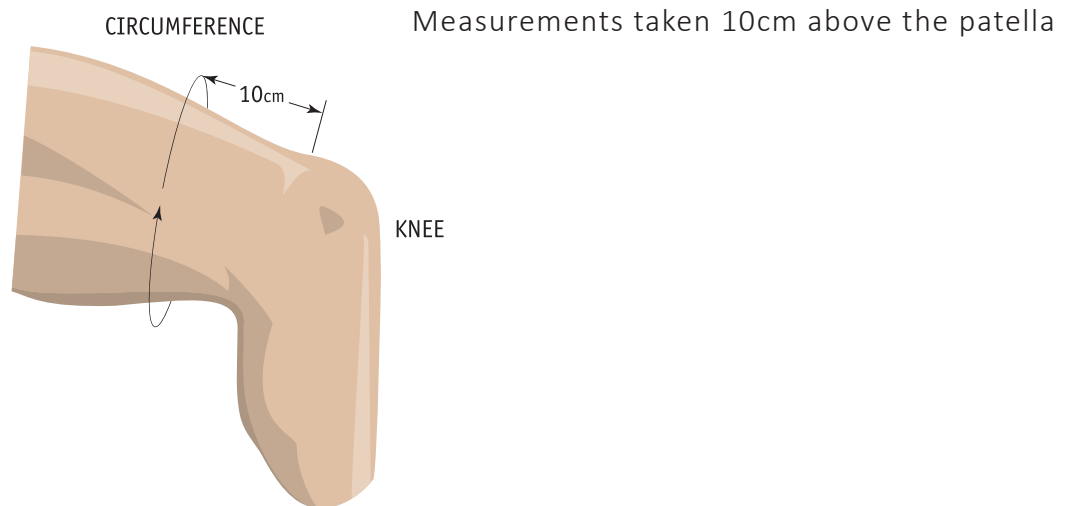

Sizing Chart

Measured Size (cm)	3mm or 6 mm Uniform
20-24 cm	SFP(HD) 16 - (3 or 6)
25-30 cm	SFP(HD) 20 - (3 or 6)
31-34 cm	SFP(HD) 24 - (3 or 6)
35-37 cm	SFP(HD) 26 - (3 or 6)
38-40 cm	SFP(HD) 28 - (3 or 6)
41-45 cm	SFP(HD) 32 - (3 or 6)
46-60 cm	SFP(HD) 38 - (3 or 6)
61-70 cm	SFP(HD) 44 - (3 or 6)

EasySleeve

SFR



EasyGel Suction Suspension Sleeve with Fabric

ALPS™ SFR has superior comfort provided by EasyGel. The elasticity of the fabric still allows the user excellent freedom of knee flexion. The SFR also achieves secure suspension by sealing with the skin without restricting circulation. The lower coefficient of friction found with the EasyGel helps relieve the skin of shear forces.



EasyGel



Beige Fabric,
Horizontal & Vertical Stretch

- High performance fabric improves durability
- EasyGel is comfortable and skin friendly
- Available in 3mm and 6mm uniform thickness



US Patent No. 7,709,570



Tel: 727.528.8566 | Tel: 800.574.5426
www.easyliner.com | info@easyliner.com

Cross Section Diagram

3mm Uniform, 6mm Uniform

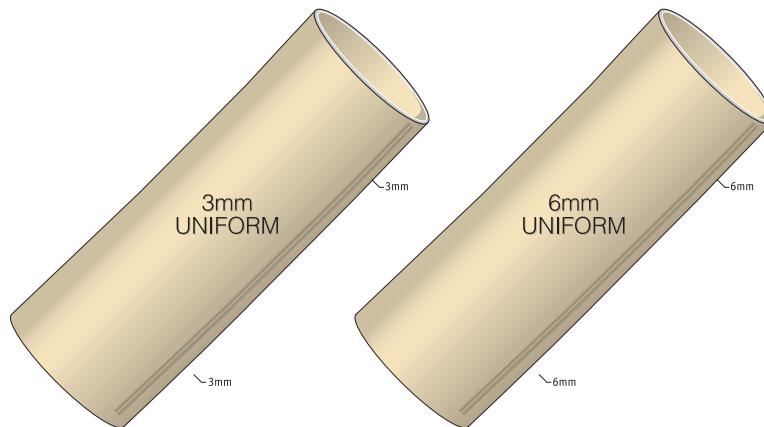

How to Size

Measurements taken 10cm above the patella

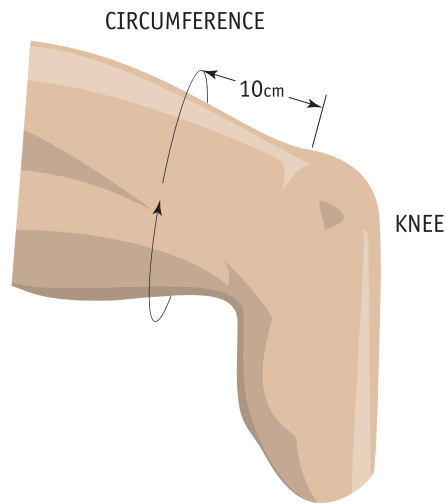

Sizing Chart

Measured Size (cm)	3mm or 6mm Uniform
16-19 cm	SFR10 - (3 or 6)
20-24 cm	SFR16 - (3 or 6)
25-30 cm	SFR20 - (3 or 6)
31-34 cm	SFR24 - (3 or 6)
35-37 cm	SFR26 - (3 or 6)
38-40 cm	SFR28 - (3 or 6)
41-45 cm	SFR32 - (3 or 6)
46-60 cm	SFR38 - (3 or 6)
61-70 cm	SFR44 - (3 or 6)

EasySleeve

SFS



GripGel Suction Suspension Sleeve



GripGel



Beige Fabric,
Horizontal & Vertical Stretch

ALPS™ SFS has superior comfort provided by GripGel. The elasticity of the fabric allows the user excellent freedom of knee flexion. The SFS also achieves secure suspension by sealing with the skin without restricting circulation, while the GripGel sticks to the patients skin without causing shear force.

- High performance fabric improves durability
- GripGel provides a tacky and secure fit
- Available in 3mm and 6mm uniform thickness



Tel: 727.528.8566 | Tel: 800.574.5426
www.easyliner.com | info@easyliner.com

Cross Section Diagram

3mm Uniform, 6mm Uniform

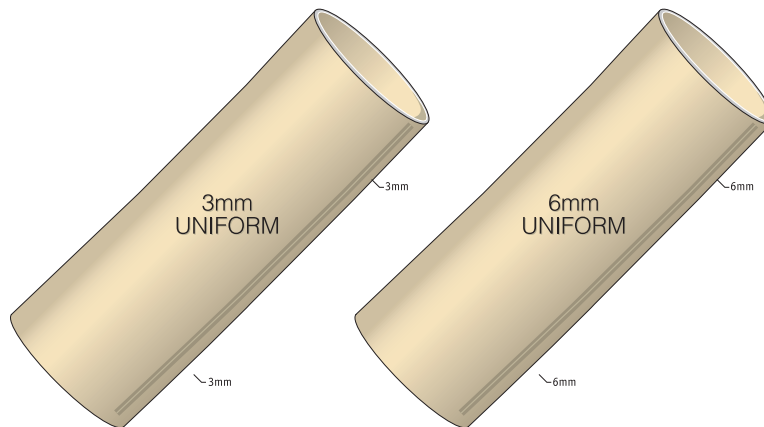

How to Size

Measurements taken 10cm above the patella

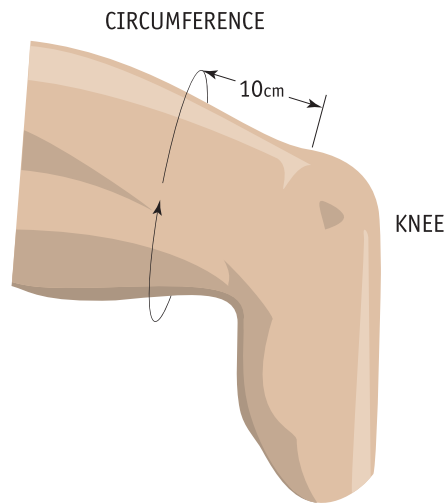

Sizing Chart

Measured Size (cm)	3mm or 6mm Uniform
20-24 cm	SFS16 - (3 or 6)
25-30 cm	SFS20 - (3 or 6)
31-34 cm	SFS24 - (3 or 6)
35-37 cm	SFS26 - (3 or 6)
38-40 cm	SFS28 - (3 or 6)
41-45 cm	SFS32 - (3 or 6)
46-60 cm	SFS38 - (3 or 6)
61-70 cm	SFS44 - (3 or 6)

FLEX Sleeve

SFX



Gel Suction Suspension Sleeve



High Density (HD) Gel

ALPS™ Flex Sleeve (SFX) is made with a seamless knitted construction in HD Gel to provide maximum comfort. The SFX has a 30° pre-flexion which allows for ease of bending of the knee and reduces bunching behind the knee.

- Features a 30° pre-flexion
- HD Gel provides active amputees a great degree of control
- Available in 3mm uniform thickness
- Available in one length that accommodates most users



Tel: 727.528.8566 | Tel: 800.574.5426
www.easyliner.com | info@easyliner.com

Cross Section Diagram

3mm Uniform

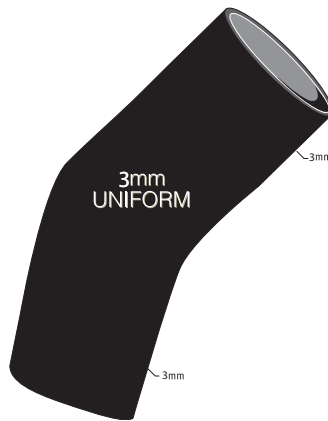

How to Size

CIRCUMFERENCE

Measurements taken 10cm above the patella

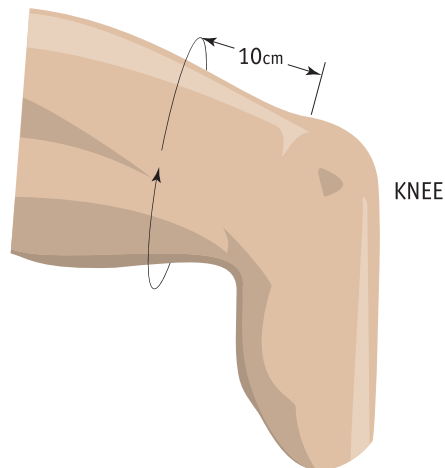

Sizing Chart

Measured Size (cm)	3mm Uniform
20-34 cm	SFX20 - 3G
31-40 cm	SFX26 - 3G
35-60 cm	SFX32 - 3G

Reinforced Clearline

SLR



Silicone Suspension Sleeve - With Fabric

ALPS™ SLR is made with thin silicone and achieves a secure suspension by sealing with the skin. It is one of the few suspension sleeves on the market that can be made custom, allowing more sizing options for practitioners. It is also available in multiple colors.

- Integrated fabric
- Standard and custom sizes available
- Available in 1.5mm uniform thickness



Tel: 727.528.8566 | Tel: 800.574.5426
www.easyliner.com | info@easyliner.com

Cross Section Diagram

1.5mm Uniform

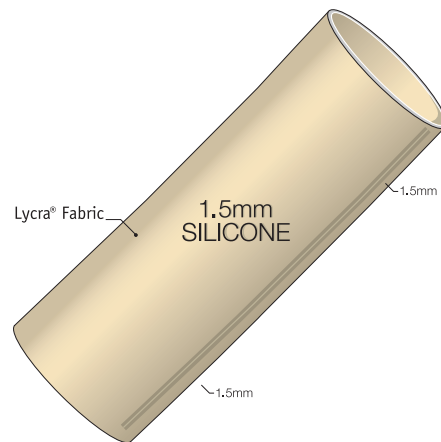

How to Size

Measurements taken 10cm above the patella

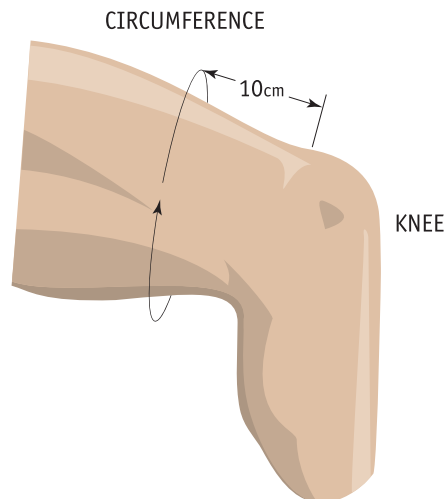

Sizing Chart

Measured Size (cm)	1.5mm Uniform	Color
Smaller than 28 cm	Custom	Black, Nude (Brown), Beige
28-32 cm	SLR - S	Black, Nude (Brown), Beige
33-34 cm	SLR - M	Black, Nude (Brown), Beige
35-37 cm	SLR - L	Black, Nude (Brown), Beige
38-40 cm	SLR - XL	Black, Nude (Brown), Beige
41-45 cm	SLR - 2XL	Black, Nude (Brown), Beige
46-51 cm	SLR - 3XL	Black, Nude (Brown), Beige
52-57 cm	SLR - 4XL	Black, Nude (Brown), Beige
58-64 cm	SLR - 5XL	Black, Nude (Brown), Beige
Greater than 64 cm	Custom	Black, Nude (Brown), Beige

EasySleeve Super Stretch

SLE



Gel Suction Suspension Sleeve - No Fabric

ALPS™ EasySleeve Super Stretch provides comfort and durability while still providing strength through suction suspension. The SLE allows freedom of knee flexion and achieves secure suspension by sealing with the skin without restricting circulation. The separate fabric cover allows the EasyGel to move with the user, therefore reducing the forces against the patella and allowing the bulk of the sleeve to be displaced away from the popliteal area.

- Minimizes compression and irritation proximally
- EasyGel is comfortable and skin friendly
- Available in 6mm uniform thickness

CSLE is available with the EasySleeve Super Stretch as a separate fabric cover.



US Patent No. 7,709,570



Tel: 727.528.8566 | Tel: 800.574.5426
www.easyliner.com | info@easyliner.com

Cross Section Diagram

6mm Uniform



How to Size

Measurements taken 10cm above the patella

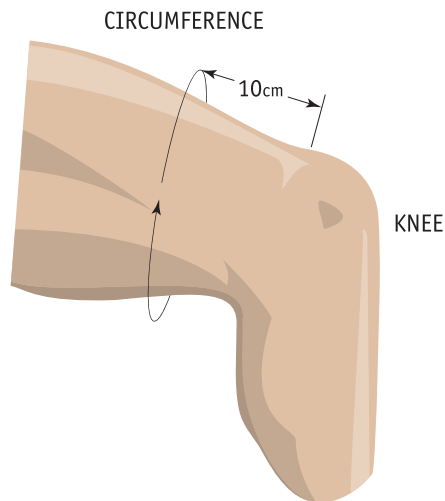

Sizing Chart

Measured Size (cm)	6mm Uniform	Cover Size
10-15 cm	SLE - 10	
16-19 cm	SLE - 16	CSLE 16
20-23 cm	SLE - 20	CSLE 20
24-25 cm	SLE - 24	CSLE 24
26-27 cm	SLE - 26	
28-31 cm	SLE - 28	CSLE 28
32-37 cm	SLE - 32	CSLE 32

Lock Flat Bottom

S496-T / S496-W

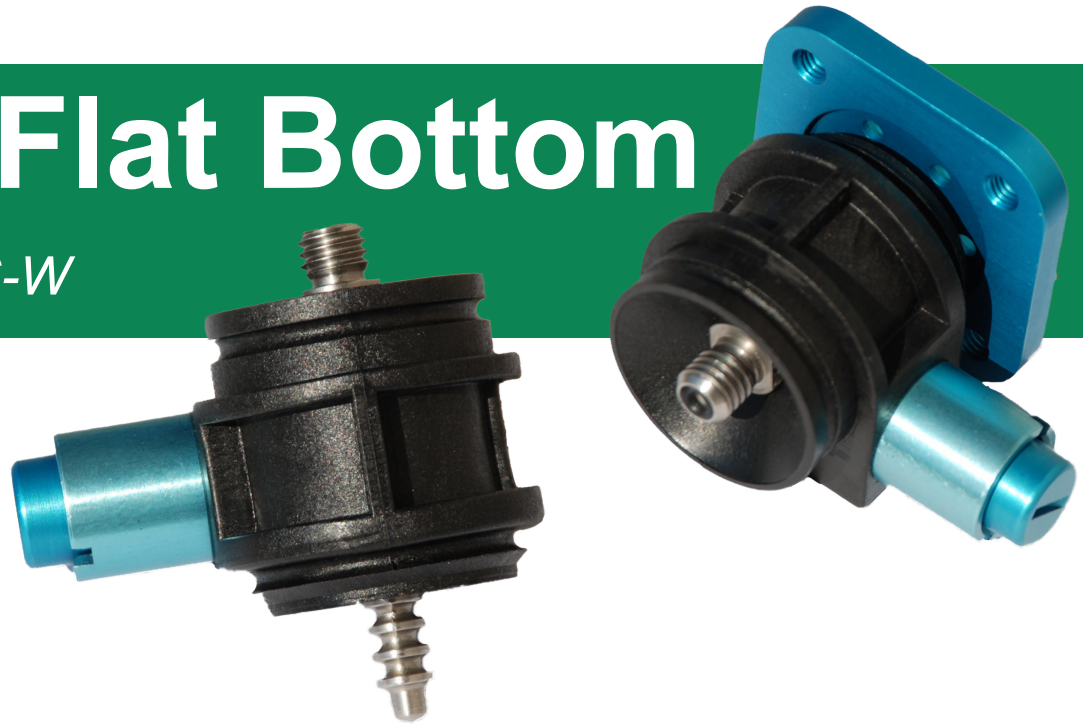

Gear Type Locking Device with or without Plate

ALPS™ Lock Flat Bottom is a lightweight locking device made of glass reinforced nylon. This lock exhibits better wear characteristics than delrin or aluminum. The convenient one-way gear allows the user to push in or wind out the limb into the socket. A unique feature of this lock is that if foreign material or clothing get caught in the gear, the housing can be removed to free the pin.

- Smooth gear mechanism
- Quiet operation
- Convenient side mounted release button
- Infinite pin adjustment reduces play
- **No weight limit**



Tel: 727.528.8566 | Tel: 800.574.5426
www.easyliner.com | info@easyliner.com

S496-T

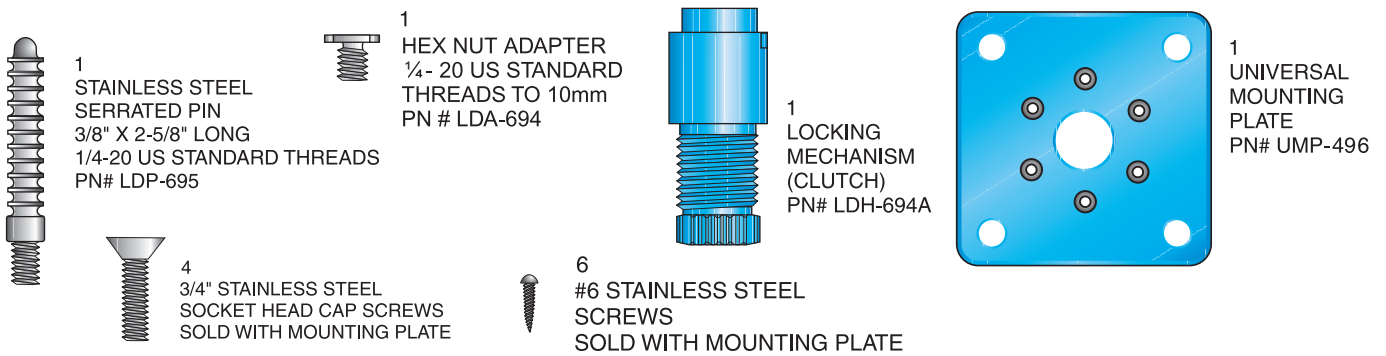

S496-W

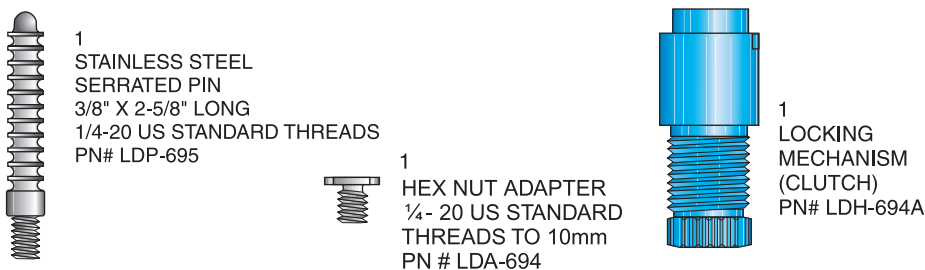

Applications



Laminations



Thermoplastics

To Order

Use Codes Provided below when ordering

Lock	Description	Spare Parts	Description
S496-T	Flat Bottom - With Plate	LDA-694	Hex Nut Adapter
S496-W	Flat Bottom - Without Plate	LDH-694A	Locking Mechanism
		LDP-695	Serrated Pin
		UMP-16	Universal Mounting Plate Only
Other	Description	UMP-496	Universal Mounting Plate Kit
FAB-946	Fabrication Kit		

Lock with Pyramid

S498-P

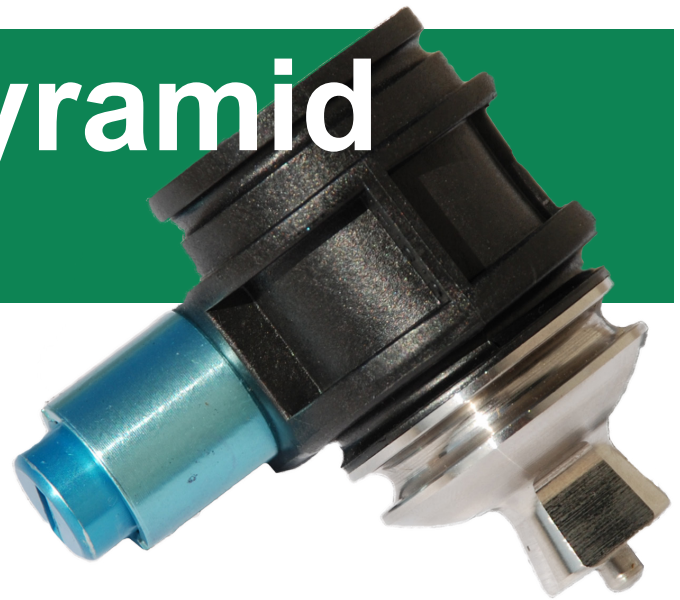

Gear Type Locking Device with Pyramid

The ALPS™ Lock with Pyramid is an all-in-one lock body design which combines the lock and pyramid. The glass reinforced nylon lock body exhibits better wear than delrin or aluminum. The convenient one-way gear allows the user to push in or wind the limb into the socket. A unique feature of this lock is that if foreign material or clothing get caught in the gear, the housing can be removed to free the pin.

- Smooth gear mechanism
- Quiet operation
- Convenient side mounted release button
- Infinite pin adjustment reduces play
- **220 lbs. (100 kg) weight rating**



Covered by one or more of the following US Patent No.
5,507,837



Tel: 727.528.8566 | Tel: 800.574.5426
www.easyliner.com | info@easyliner.com



1
STAINLESS STEEL
SERRATED PIN
3/8" X 2-5/8" LONG
1/4-20 US STANDARD THREADS
PN# LDP-695



1
HEX NUT ADAPTER
1/4 - 20 US STANDARD
THREADS TO 10mm
PN # LDA-694

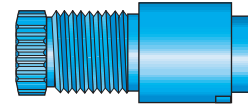

1
LOCKING
MECHANISM
(CLUTCH)
PN # LDH-694A

Applications

<input checked="" type="checkbox"/>	Laminations
<input type="checkbox"/>	<i>Thermoplastics</i>

To Order

Use Codes Provided below when ordering

Lock	Description
------	-------------

S496-P	Lock with Pyramid
--------	-------------------

Spare Parts	Description
-------------	-------------

LDA-694	Hex Nut Adapter
LDH-694A	Locking Mechanism
LDP-695	Serrated Pin

Other	Description
-------	-------------

FAB-946	Fabrication Kit
---------	-----------------

Prosthetic Skin Lotion

SL108

Prosthetic Skin Lotion for Sensitive Skin

ALPS™ 100% Silicone Skin Lotion helps to soothe dry, sensitive skin. It is hypoallergenic, with no perfumes or dyes, and minimal residue. Can be used sparingly to relieve dry, chapped skin conditions.



Recommended for use with:

- Gel (Thermoplastic) - All ALPS™ Gel Liners**
- Silicone - CLEARPRO**
- Urethane**

PRODUCT NUMBER

SL108 **Prosthetic Skin Lotion**, 4 oz.

SL108 BX12 **Prosthetic Skin Lotion**, 4 oz. Box of 12

SL108-32 **Prosthetic Skin Lotion**, 32 oz.



Tel: 727.528.8566 | Tel: 800.574.5426
www.easyliner.com | info@easyliner.com

Prosthetic Lubricant

PA604



70% Isopropyl Alcohol Prosthetic Lubricant for Liners

ALPS™ Prosthetic Lubricant is used to help in donning prosthetic liners. It allows the patient to don the liner or sheath easily while eliminating the sticky feel.

Recommended for use with:

- Gel (Thermoplastic) - All ALPS™ Gel Liners
- Silicone - CLEARPRO
- Urethane

PRODUCT NUMBER

PA604 **Prosthetic Lubricant**, 16 oz.

PA604 BX12 **Prosthetic Lubricant**, 16 oz. Box of 12



Tel: 727.528.8566 | Tel: 800.574.5426
www.easyliner.com | info@easyliner.com

Prosthetic Cleanser

PD595

Prosthetic Cleanser for Sensitive Skin



ALPS™ Prosthetic Cleanser is a non-alkaline, soap-free cleanser which can be used for either hand or machine washing of prosthetic liners or sleeves. Patients with sensitive skin may also find that this soothing cleansing agent is ideal for washing skin areas that come into contact with the prosthesis.

Recommended for use with:

- Gel (Thermoplastic) - All ALPS™ Gel Liners**
- Silicone - CLEARPRO**
- Urethane**

PRODUCT NUMBER

PD595 **Prosthetic Cleanser**, 16 oz.

PD595 BX12 **Prosthetic Cleanser**, 16 oz. Box of 12



Tel: 727.528.8566 | Tel: 800.574.5426
www.easyliner.com | info@easyliner.com

Prosthetic Ointment

PO840

Prosthetic Ointment Soothes and Protects

ALPS™ Prosthetic Ointment is a vitamin A and D formulation that soothes and protects the skin. It may be applied nightly after the prosthesis has been removed. Ideal for amputees with sensitive skin or irritation. **May not be used while wearing ALPS Gel Products.**



Recommended for use with:



~~Gel (Thermoplastic) — All ALPS™ Gel Liners*~~



Silicone - CLEARPRO



Urethane

*May deteriorate gel over time

PRODUCT NUMBER

PO840 Prosthetic Ointment, 4 oz.

PO840 BX12 Prosthetic Ointment, 4 oz. Box of 12



Tel: 727.528.8566 | Tel: 800.574.5426
www.easyliner.com | info@easyliner.com

Prosthetic Anti-Perspirant

ATP008

Prosthetic Anti-Perspirant

The first anti-perspirant truly designed for prosthetics. Created to help manage the continuing problem of perspiration, it has been formulated with twice the Aluminum Chlorohydrate found in over the counter anti-perspirants.



Recommended for use with:

- Gel (Thermoplastic) - All ALPS™ Gel Liners
- Silicone - CLEARPRO
- Urethane

PRODUCT NUMBER

ATP008 **Prosthetic Anti-Perspirant**, 4 oz.

ATP008 BX12 **Prosthetic Anti-Perspirant**, 4oz. Box of 12



Tel: 727.528.8566 | Tel: 800.574.5426
www.easyliner.com | info@easyliner.com

Antioxidant Balm and Cream

ANT-B50 / ANT-C50



Prosthetic Balm and Cream for Sensitive Skin

ALPS™ Antioxidant Balm and Cream contains antioxidants that are an effective hydroxyl scavenger. May assist with soothing pain, itchiness, and irritated skin.

Recommended for use with:

- Gel (Thermoplastic) - All ALPS Gel Liners
- Silicone - CLEARPRO
- Urethane

PRODUCT NUMBER

ANT-B50 BX12 **Antioxidant Balm**, 50ml Box of 12
ANT-C50 BX12 **Antioxidant Cream**, 50ml Box of 12



Tel: 727.528.8566 | Tel: 800.574.5426
www.easyliner.com | info@easyliner.com

Padsil

PDS



Silicone Distal Pad

The Padsil was developed to increase patient comfort in combination with ALPS™ liners. The more active user will appreciate the additional cushioning, softness, and durability. Users who experience volume changes will also appreciate the Padsils ability to lift the limb back into the proper position. They can be placed at the bottom of the socket or inside a pin locking liner.

- Soft medical grade silicone
- Keeps its shape over time
- Helps maintain total contact
- Easily modified
- Blue dummy padsils are available for laminating

PRODUCT NUMBER

PDS-XX **Silicone Distal Pad**

PDSB-XX **Blue Dummy Distal Pad**

*XX indicates size, see sizing chart and illustrations on reverse for further details.



Tel: 727.528.8566 | Tel: 800.574.5426
www.easyliner.com | info@easyliner.com

Fitting Diagram

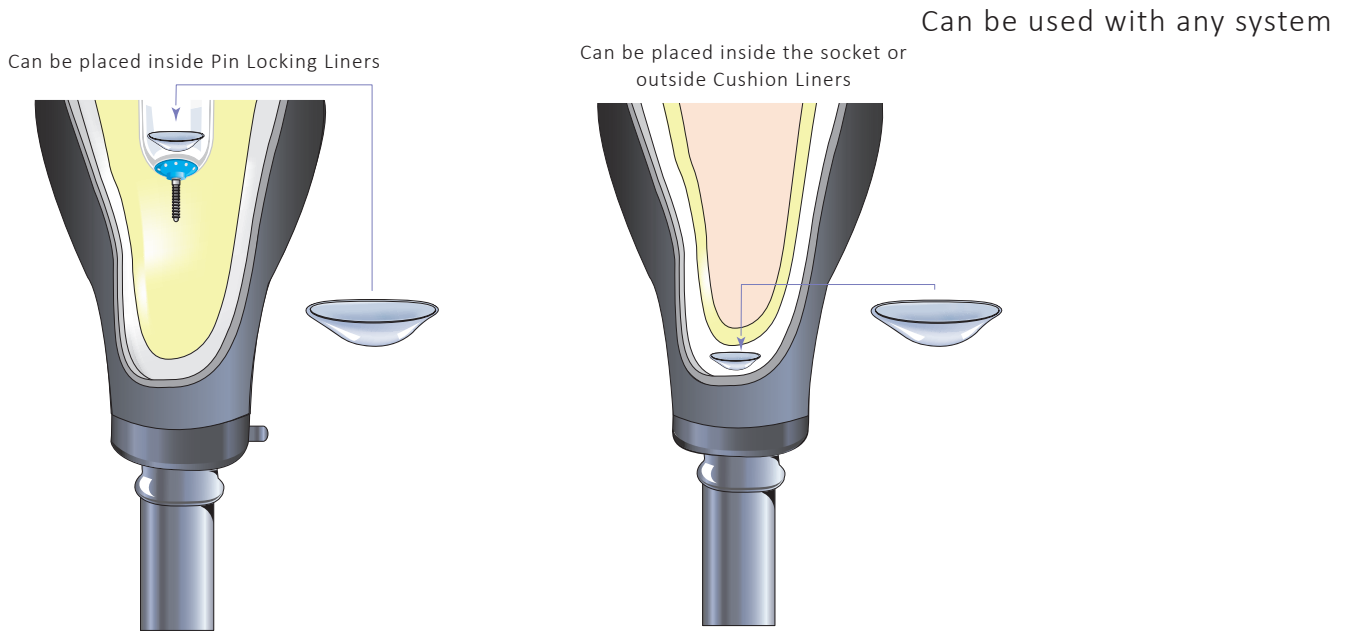

Padsil Durometer

Part	Size	Durometer
Padsil (PDS)	S-XXL	35-55
Padsil Dummy (PDSB)	S-XXL	65-85

Sizing Chart

Measurements taken 6cm from the distal end

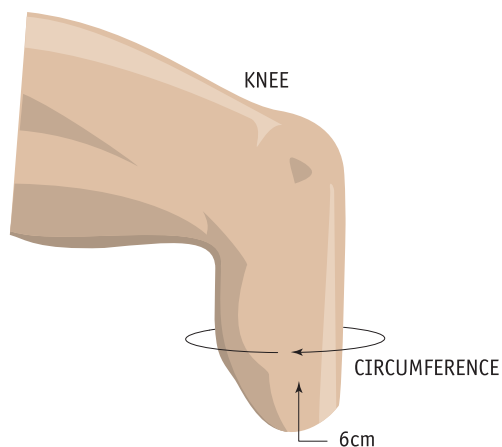

Measured Size (cm)	
14-19 cm	PDS-S
20-23 cm	PDS-M
24-27 cm	PDS-L
28-31 cm	PDS-XL
32-35 cm	PDS-XXL

ALPS South, LLC 2895 42nd Avenue North
 St. Petersburg, Florida 33714
 Tel: 727.528.8566 FAX: 727.528.8862 Email: info@easyliner.com

Skin Reliever

ENCP



Gel Sheath - No Fabric or Distal Attachment

The ALPS™ Skin Reliever, made with EasyGel, eliminates shear forces, friction, and prevents abrasions on the skin of the stump. It's tapered structure accommodates volume fluctuations over the life of the prosthesis. It provides superior elongation for very little compression against the skin, reducing abrasions. ALPS Skin Reliever can be worn under silicone or gel, and can be used to replace socks.

- Features ALPS EasyGel
- Replaces socks
- High elasticity
- Reduces shearing and abrasions
- May soften and soothe skin

PRODUCT NUMBER

ENCP-XX **Skin Reliever**, Tapered from 3mm - 1.5mm

*XX indicates size, see sizing chart and illustrations on reverse for further details.



US Patent No. 7,709,570



Tel: 727.528.8566 | Tel: 800.574.5426
www.easyliner.com | info@easyliner.com

Cross Section Diagram

3mm-1.5mm Tapered

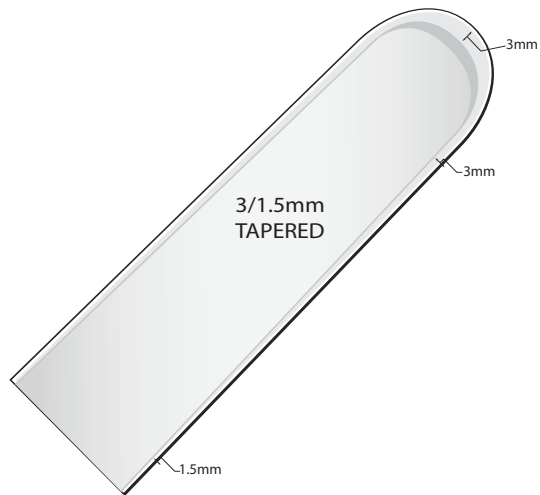

How to Size

Measurements taken 6cm from the distal end

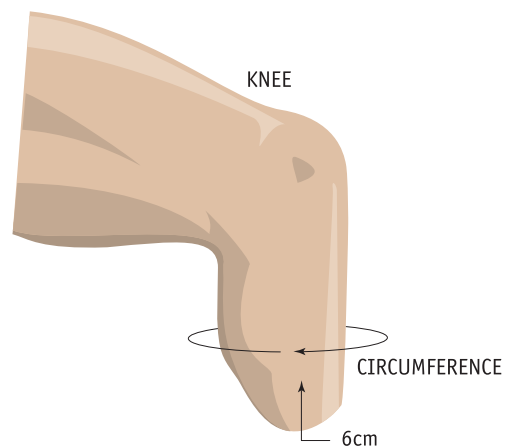

Sizing Chart

Measured Size (cm)	
10-19 cm	ENCP 16
20-27 cm	ENCP 20
28-31 cm	ENCP28

EasySkin™

TSK



Protective Cosmetic Cover

ALPS™ cosmetic covers are pre-stretched and are heated to shrink to size. These covers are highly comfortable, pre-stretched and have no transition line at the ankle. They are ideal for transtibial patients and are available in 7 shades to accommodate most users.

- Highly conformable
- Two sizes to accommodate most users
- Pre-Stretched, heat shrink to fit
- No transition line at the ankle



PRODUCT NUMBER

TSK-X-L **EasySkin**, Large

TSK-X-S **EasySkin**, Small

*X indicates color, see color chart and illustrations on reverse for further details.
Color Swatches are available upon request.



Tel: 727.528.8566 | Tel: 800.574.5426
www.easyliner.com | info@easyliner.com

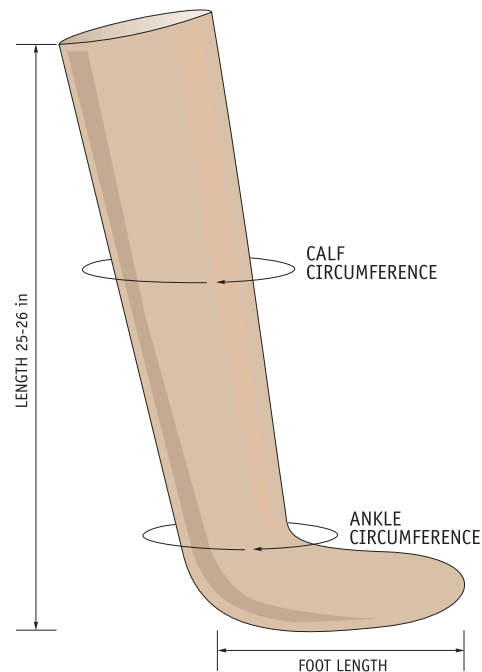

Sizing Chart

All ankle and calf measurements taken in centimeters

Size	Foot Length	Ankle	Calf
SMALL			
Minimum	18 cm	17 cm	25 cm
Maximum	23 cm	22 cm	35 cm
LARGE			
Minimum	23 cm	22 cm	35 cm
Maximum	30 cm	29 cm	45cm

Instructions

After pulling skin over prosthesis, use a heat gun to shrink the skin starting at the toes and working up to the proximal brim. If needed, a vinyl contact cement can be used or super glue for a permanent bond. For use with suction suspension applications, place a small hole so the cosmetic cover does not inflate.

ALPS South, LLC
 2895 42nd Avenue North
 St. Petersburg, Florida 33714
 Tel: 727.528.8566 FAX: 727.528.8862 Email: info@easyliner.com

Prosthetic Socks

KCN / KCM / KCW



Sock - Reinforced Hole or No Hole

The ALPS™ prosthetic sock is lightweight and soft, providing cushioning and comfort for a superior fit. The socks are manufactured with Coolmax® fibers to create a moisture management system which moves perspiration away from the body and through the fabric, where it can evaporate quickly.

- Assists with volume fluctuation
- Available in 1, 3, and 5 ply
- Coolmax® fibers allow a cool, comfortable wear
- Keeps its shape over time; minimal stretch and will not mat down
- Socks with distal hole are only available with plastic reinforcement

PRODUCT NUMBER

KCN-XX-XX **Narrow Socks**, Reinforced Hole or No Hole

KCM-XX-XX **Medium Socks**, Reinforced Hole or No Hole

KCW-XX-XX **Wide Socks**, Reinforced Hole or No Hole

* XX indicates size, see sizing chart and illustrations on reverse for details on sizing and differences between configurations.



Tel: 727.528.8566 | Tel: 800.574.5426
www.easyliner.com | info@easyliner.com

Fitting Diagram

Measurements taken 2 inches from the distal end

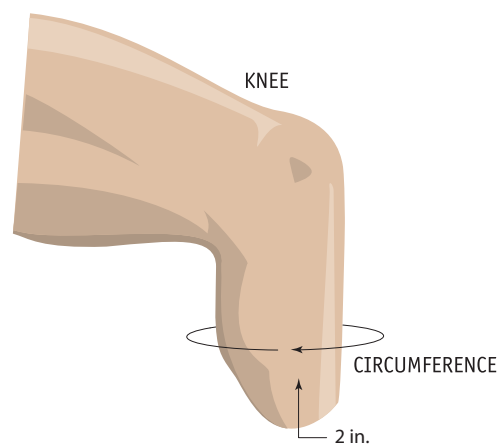
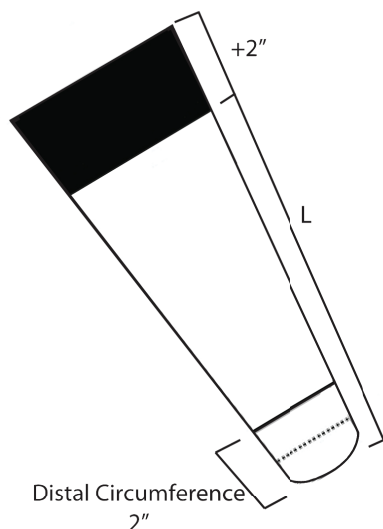

Sizing Chart

Measured Size (cm) Distal Circumference	Length of Socket + 2 inches	Sock Description	ALPS Part Number 1, 3, or 5 ply / (N) No Hole (HR) Hole Reinforced
8"-9" (20-23 cm)	8"-10" (20-26 cm)	Narrow Extra Short	KCN-08-(ply)(N/HR)
8"-9" (20-23 cm)	10"-14" (26-36 cm)	Narrow Short	KCN-10-(ply)(N/HR)
8"-9" (20-23 cm)	14"-18" (36-46 cm)	Narrow Regular	KCN-14-(ply)(N/HR)
8"-9" (20-23 cm)	18"-24" (46-60 cm)	Narrow Long	KCN-18-(ply)(N/HR)
9"-12" (23-31 cm)	8"-10" (20-26 cm)	Medium Extra Short	KCM-08-(ply)(N/HR)
9"-12" (23-31 cm)	10"-14" (26-36 cm)	Medium Short	KCM-10-(ply)(N/HR)
9"-12" (23-31 cm)	14"-18" (36-46 cm)	Medium Regular	KCM-14-(ply)(N/HR)
9"-12" (23-31 cm)	18"-24" (46-60 cm)	Medium Long	KCM-18-(ply)(N/HR)
12"-14" (31-36 cm)	8"-10" (20-26 cm)	Wide Extra Short	KCW-08-(ply)(N/HR)
12"-14" (31-36 cm)	10"-14" (26-36 cm)	Wide Short	KCW-10-(ply)(N/HR)
12"-14" (31-36 cm)	14"-18" (36-46 cm)	Wide Regular	KCW-14-(ply)(N/HR)
12"-14" (31-36 cm)	18"-24" (46-60 cm)	Wide Long	KCW-18-(ply)(N/HR)

Knee Brace

KBHP / KBHW



Knee Brace with Adjustable Hinges

The ALPS™ knee Brace is constructed of neoprene fabric with adjustable hinges. The brace is designed to prevent or reduce the severity of a knee injury. It is available in a pull-on or wrap-around style.

- Hinges with flexion or extension adjustment
- Medial and lateral support
- Airslots behind the knee
- Neoprene fabric
- Latex Free

Size	Measured Size Inches	Measured Size Centimeters
X-Small*	11.0 - 13.0	28.0 - 33.0
Small	13.5 - 15.0	34.3 - 38.1
Medium	15.5 - 17.0	39.4 - 43.2
Large	17.5 - 22.0	44.5 - 55.9
X-Large	22.5 - 24.0	57.2 - 61.0
XX-Large	24.5 - 27.0	62.2 - 68.6
XXX-Large	27.5 - 30.0	69.9 - 76.2

*Size XS- Limited, Check availability with Customer Service

*Measure four inches (10 cm) above the top of the kneecap while standing

PRODUCT NUMBER

KBHP-XX **Knee Brace**, Pull-on with Hinge

KBHW-XX **Knee Brace**, Wrap Around with Hinge

*XX indicates size



CAN#6787 Form #100449 Rev D



Tel: 727.528.8566 | Tel: 800.574.5426
www.easyliner.com | info@easyliner.com

Knee Brace

KBP / KBW



Knee Brace without Adjustable Hinges

The ALPS™ knee Brace is constructed of neoprene fabric without adjustable hinges. The brace is designed to prevent or reduce the severity of a knee injury. It is available in a pull-on or wrap-around style.

- Airslots behind the knee
- Neoprene fabric
- Provides compression and warmth
- Latex Free

Size	Measured Size Inches	Measured Size Centimeters
X-Small*	11.0 - 13.0	28.0 - 33.0
Small	13.5 - 15.0	34.3 - 38.1
Medium	15.5 - 17.0	39.4 - 43.2
Large	17.5 - 22.0	44.5 - 55.9
X-Large	22.5 - 24.0	57.2 - 61.0
XX-Large	24.5 - 27.0	62.2 - 68.6
XXX-Large	27.5 - 30.0	69.9 - 76.2

*Size XS- Limited, Check availability with Customer Service

*Measure four inches (10 cm) above the top of the kneecap while standing

PRODUCT NUMBER

KBP-XX **Knee Brace**, Pull-on without Hinge

KBW-XX **Knee Brace**, Wrap Around without Hinge

*XX indicates size



Coolfit Extended Knee Brace

FIT



Coolfit Knee Brace with Adjustable Hinges

The ALPS™ Coolfit Knee Brace is constructed with breathable fabric and is designed to prevent or reduce the severity of a knee injury. The Coolfit is manufactured longer in length than our standard braces and is available in pull-on and wrap-around styles.

- Coolfit breathable fabric allows for improved air circulation
- Works well for patients who are allergic to neoprene knee braces
- Hinges with flexion or extension adjustment
- Medial and lateral support
- Four adjustable velcro straps to ensure stability
- Latex Free

Size	Measured Size Inches	Measured Size Centimeters
X-Small*	11.0 - 13.0	28.0 - 33.0
Small	13.5 - 15.0	34.3 - 38.1
Medium	15.5 - 17.0	39.4 - 43.2
Large	17.5 - 22.0	44.5 - 55.9
X-Large	22.5 - 24.0	57.2 - 61.0
XX-Large	24.5 - 27.0	62.2 - 68.6
XXX-Large	27.5 - 30.0	69.9 - 76.2

*Size XS- Limited, Check availability with Customer Service

*Measure four inches (10 cm) above the top of the kneecap while standing

PRODUCT NUMBER

FIT-HP-XX **Coolfit Knee Brace, Pull-on with Hinge**

FIT-HW-XX **Coolfit Knee Brace, Wrap Around with Hinge**

*XX indicates size



CAN#6781 Form #100443 Rev D



Tel: 727.528.8566 | Tel: 800.574.5426
www.easyliner.com | info@easyliner.com

Coolfit Knee Brace

CFB



Coolfit Knee Brace with Adjustable Hinges

The ALPS™ Coolfit Knee Brace is constructed with breathable fabric and is designed to prevent or reduce the severity of a knee injury. The Coolfit is available in pull-on and wrap-around style.

- Coolfit breathable fabric allows for air circulation
- Works well for patients who are allergic to neoprene knee braces
- Hinges with flexion or extension adjustment
- Medial and lateral support
- Latex Free

Size	Measured Size Inches	Measured Size Centimeters
X-Small*	11.0 - 13.0	28.0 - 33.0
Small	13.5 - 15.0	34.3 - 38.1
Medium	15.5 - 17.0	39.4 - 43.2
Large	17.5 - 22.0	44.5 - 55.9
X-Large	22.5 - 24.0	57.2 - 61.0
XX-Large	24.5 - 27.0	62.2 - 68.6
XXX-Large	27.5 - 30.0	69.9 - 76.2

*Size XS- Limited, Check availability with Customer Service

*Measure four inches (10 cm) above the top of the kneecap while standing

PRODUCT NUMBER

CFB-HP-XX **Coolfit Knee Brace, Pull-on with Hinge**

CFB-HW-XX **Coolfit Knee Brace, Wrap Around with Hinge**

*XX indicates size



CAN#6782 Form #100444 Rev D



Tel: 727.528.8566 | Tel: 800.574.5426
www.easyliner.com | info@easyliner.com

Back Brace

BB04

Neoprene Back Support



The ALPS™ BB04 Back Support helps guard against back strains, sprains, and muscle spasms. The neoprene fabric allows for therapeutic warmth to the lumbar region. The brace is incorporated with four removable plastic stays to prevent rollover and allow for strength and stability.

- Lightweight and comfortable
- Four removable stays along the backside
- Simple Hook and Loop Closure allows for easy application
- Added tension straps to provide additional compression and support
- Removable Lumbar Pad
- Latex Free

Size	Measured Size Inches	Measured Size Centimeters
Small	24 - 30	61 - 76.2
Medium	30 - 36	76.3 - 91.4
Large	36 - 42	91.5 - 106.7
X-Large	42 - 50	106.8 - 127
XX-Large	50 - 56	127.1 - 142.2

*Measurements taken at center of the waist

PRODUCT NUMBER

BB04-XX **Back Brace**

*XX indicates size



CAN#6785 Form #100447 Rev C



Tel: 727.528.8566 | Tel: 800.574.5426
www.easyliner.com | info@easyliner.com

Back Brace

BB06

Back Support



The ALPS™ Ventilated Elastic Back Support helps prevent and relieve lower back pain resulting from muscle spasms and strains. It provides support and compression to the lower lumbar and abdominal regions. Integrated plastic stays along backside to ensure stability.

- Cool, lightweight, and comfortable
- Seven lateral stays incorporated
- Ideal for post abdominal surgery
- Added tension straps for more support
- Hides well under clothing
- Latex Free

Size	Measured Size Inches	Measured Size Centimeters
Small	24.5 - 29.4	62.2 - 74.7
Medium	29.5 - 34.9	75.0 - 88.6
Large	35.0 - 39.9	88.9 - 101.3
X-Large	40.0 - 45.9	101.6 - 116.6
XX-Large	46.0 - 52.0	116.8 - 132.1

*Measurements taken at center of the waist

PRODUCT NUMBER

BB06-XX **Back Brace**

*XX indicates size



CAN#6784 Form #100446 Rev D



Tel: 727.528.8566 | Tel: 800.574.5426
www.easyliner.com | info@easyliner.com

Back Brace

BB08



Lumbosacral Support

The ALPS™ BB08 Back Support helps prevent and relieve lower back pain resulting from muscle spasms and strains. It provides support and compression to the lower lumbar and abdominal regions. Integrated plastic stays along backside ensure stability. Stays are removable if needed.

- Lightweight and comfortable
- Four removable lateral stays along the backside
- Simple Hook and Loop Closure allows for easy application
- Adjustable tension straps to provide additional compression and support
- Removable Lumbar Pad
- ***Contains Latex**

Size	Measured Size Inches	Measured Size Centimeters
Small	25.0 - 30.5	63.0 - 77.4
Medium	30.5 - 35.0	77.5 - 88.9
Large	35.0 - 40.5	89.0 - 102.8
X-Large	40.5 - 46.0	102.9 - 116.8
XX-Large	46.0 - 52.0	116.9 - 132.1

*Measurements taken at center of the waist

PRODUCT NUMBER

BB08-XX Back Brace

*XX indicates size



CAN#6783 Form #100445 Rev D



Tel: 727.528.8566 | Tel: 800.574.5426
www.easyliner.com | info@easyliner.com

Ankle Brace

ABS



Neoprene Ankle Support

The ALPS™ Ankle Brace is constructed of neoprene fabric and comes with two attached support straps. Integrated plastic stays on each side of the ankle to ensure stability.

- Soft neoprene blend provides warmth and gentle compression
- Hook and Loop strap for easy on and off
- Protects sprained ankles
- Bilateral stays on both sides control eversion without restricting normal range of motion
- Adjustable tension straps have the functionality of an athletic figure 8 bandage
- Fits right or left
- Latex Free

Size	Measured Size Inches	Measured Size Centimeters
Small	11 - 12	27.9 - 30.5
Medium	12 - 13	30.6 - 33.0
Large	13 - 14	33.1 - 35.6
X-Large	14 - 15	35.7 - 38.1



*Measure the circumference of the ankle at widest point.

PRODUCT NUMBER

ABS-X Ankle Brace

*X indicates size



CAN#6780 Form #100442 Rev C



Tel: 727.528.8566 | Tel: 800.574.5426
www.easyliner.com | info@easyliner.com

Wrist Brace

WB



Neoprene Wrist Brace

The ALPS™ Wrist Brace restricts motion to the wrist and metacarpal joints following surgery or injury. The wrist is immobilized in a natural position by direct compression, relieving pain and helping to prevent re-injury. The brace contains a removable, malleable palmar stay support for custom fit and adjustment.

- Firm support for sprains and strains
- Provides compression and support
- Highest degree of durability and immobilization
- Soft comfortable inner liner with stretch and support
- Breathable and functional wrist support
- Latex Free

PRODUCT NUMBER

WB-L **Left Wrist Brace**, Universal Sizing

WB-R **Right Wrist Brace**, Universal Sizing



CAN#6778 Form #100440 Rev C

Tel: 727.528.8566 | Tel: 800.574.5426
www.easyliner.com | info@easyliner.com

Thumb Brace

TB



Nylon Thumb Brace

The ALPS™ Thumb Brace restricts motion to the wrist, thumb, and metacarpal joints following surgery or injury. The thumb is immobilized in a natural position, relieving pain and helping to prevent re-injury. The brace contains a removable, metal stay on the palmar surface for custom fit and adjustment.

- Lightweight and durable fabric
- Thumb spica supports and protects the thumb
- Adjustable thumb strap enhances ease of application and patient fit
- Soft comfortable inner liner with stretch and support
- Latex Free

PRODUCT NUMBER

TB-L **Left Thumb Brace**, Universal Sizing

TB-R **Right Thumb Brace**, Universal Sizing



CAN#6779 Form #100441 Rev C

Tel: 727.528.8566 | Tel: 800.574.5426
www.easyliner.com | info@easyliner.com