

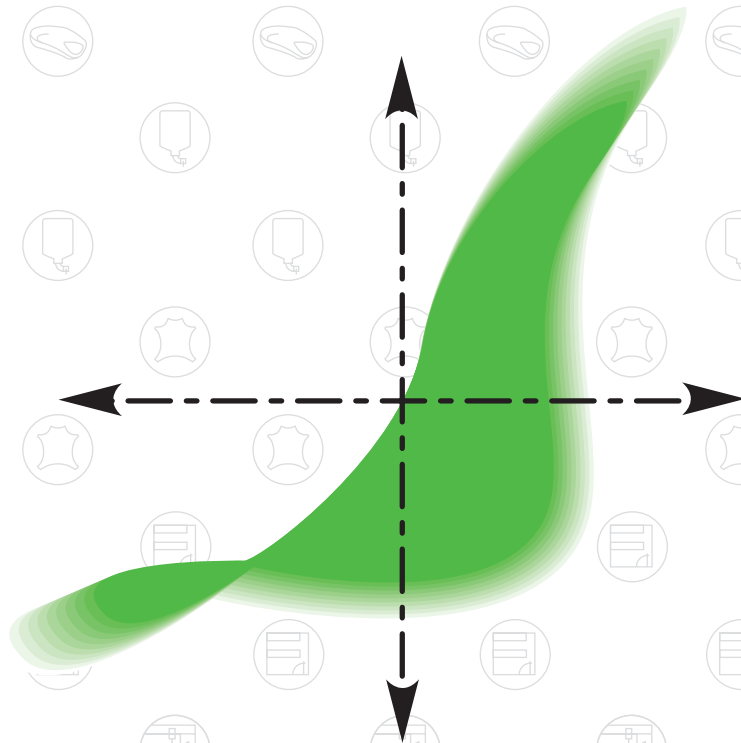

AFT[®]

AFT-International.com

MATERIALS | CATALOGUE 2018



AFT[®]

AFT-International.com

**MATERIALIEN
MATERIALS
MATERIALEN
MATERIAUX**

2018

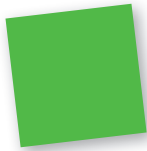

ZEICHENERKLÄRUNG SYMBOLS SYMBOLLEN LÉGENDE



FARBEN
COLOUR
KLEUR
COULEUR



GRÖSSE
SIZE
MAAT
POINTURE



BREITE
WIDTH
BREEDTE
LARGEUR



LÄNGE
LENGTH
LENGTE
LONGUEUR



ABMESSUNGEN
DIMENSIONS
AFMETINGEN
DIMENSIONS



STÄRKE
THICKNESS
DIKTE
ÉPAISSEUR



INHALT
CONTENT
INHOUD
CONTENU



HÄRTE / SHORE
HARDNESS / SHORE
HARDHEID / SHORE
DURETÉ / SHORE



FORM
MODEL
MODEL
MODÈLE



AUSFÜHRUNG
FINISH
AFWERKING
FINITION



MATERIAL
MATERIAL
MATERIAAL
MATIÈRE



VERPACKUNGSEINHEIT, P = PAAR
PACKAGING, P = PAIR
EENHEIDSVERPAKKING, P = PAAR
EMBALLAGE, P = PAIRE



SIEHE
SEE
ZIE
VOIR

PRINT 04/2016

[Technische] Änderungen und Druckfehler vorbehalten

[Technical] changes and misprints excepted

Onder voorbehoud van [technische] wijzigingen en drukfouten

Sous réserve des modification (techniques) et fautes d'impressions

Design/layout: FABworks.be

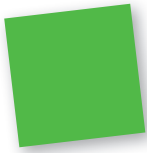

AFT | IHRE PARTNER

Der Zusammenschluss zweier seit Jahrzenten weltweit operierender Hersteller mit den Produkten 'EXTRA' und 'MEBUS' sind gemeinsam über 200 Jahre Erfahrung in den Bereichen Orthopädie und Schuhreparatur!

Wir haben die Kompetenz, alle Artikel individuell und flexibel im Sinne des Kunden anbieten zu können.

Das bedeutet nicht nur über ein Sortiment von 30000 Artikeln zu verfügen, sondern vor allem mit dem Know-How vieler sehr erfahrener Mitarbeiter rechnen zu können.

AFT | YOUR PARTNER

The combination of two well respected companies acting since many years world-wide with their products 'EXTRA' and 'MEBUS', means together more than 200 years experience and know-how in the field of orthopaedics and shoe repair!

We have the competency and ability to offer all articles in an individual and flexible way and that according to your requirements.

A team of people with an extensive knowledge of the business and many years of experience is ready to assist you with our extensive range of more than 30.000 articles.

AFT | UW PARTNER

De combinatie van twee gerespecteerde firma's die reeds sinds vele jaren wereldwijd hun producten 'EXTRA' en 'MEBUS' verdelen, betekent samen meer dan 200 jaar ervaring en knowhow op het gebied van orthopedie en schoenreparatie!

Wij hebben de deskundigheid en bekwaamheid om u al onze artikels op een individuele en flexibele manier aan te bieden volgens uw behoeften.

Een team van mensen met een uitgebreide kennis van zaken en vele jaren ervaring staat klaar om u verder te helpen met ons zeer uitgebreid assortiment van meer dan 30.000 artikelen.

AFT | VOTRE PARTENAIRE

La combinaison de deux sociétés renommées qui coopèrent depuis longtemps ensemble dans le monde entier par leurs marques déposées 'EXTRA' et 'MEBUS', représente plus de 200 ans d'expérience et savoir-faire dans le domaine de l'orthopédie et de la réparation des chaussures!

Nous avons la compétence ainsi que la possibilité de vous offrir tous les articles d'une manière individuelle et flexible afin de pouvoir répondre à vos exigences.

Une équipe de personnes ayant une connaissance approfondie de notre industrie et de nombreuses années d'expérience, est prêt à vous aider avec notre vaste gamme de plus de 30.000 articles.

Christophe Speelmans
AFT INTERNATIONAL | **BELGIUM**

Peter Mebus
AFT INTERNATIONAL | **GERMANY**



AFT International nv
Ter Stratenweg 50,
B-2520 Oelegem, BELGIUM
T: +32 (0)3 475 93 03
F: +32 (0)3 475 93 20
info@aft-international.be



AFT International GmbH
Eichenhofer Weg 1
D-42279 Wuppertal, GERMANY
T: +49 (0)202 64774 0
F: +49 (0)202 64774 20
info@aft-international.de

AFT INTERNATIONAL | GERMANY

WERKSTATTEINRICHTUNGEN
 WORK SHOP FURNISHING
 WERKPLAATSINRICHTING
 ÉQUIPEMENT D'ATELIER **6** 

MASCHINEN UND ZUBEHÖR
 MACHINERY AND ACCESSORIES
 MACHINES EN TOEBEHOREN
 MACHINES ET ACCESSOIRES **7** 

WERKZEUGEN UND KLEINMASCHINEN
 TOOLS AND SMALL MACHINERY
 GEREEDSCHAPPEN EN KLEINE MACHINES
 OUTILS ET PETITES MACHINES **9** 



PLATTENMATERIAL
SHEET MATERIAL
PLAATMATERIAAL
PLAQUES

1



ABSÄTZE, SOHLEN, STREIFEN
HEELS, SOLES, STRIPES
HAKKEN, ZOLEN, STROKEN
TALONS, SEMELLES , BANDES DÉCOUPÉES

2



EINLAGEN-ROHLINGE UND ZUBEHÖR, FRÄSTECHNIK
ORTHOPAEDIC FOOT SUPPORTS AND ACCESSORIES, MILLING TECHNIQUES
STEUNZOLEN EN TOEBEHOREN, FREESTECHNIEK
SEMELLES ORTHOPÉDIQUES ET ACCESSOIRES, TECHNIQUE À FRAISER

3



CHEMISCHE PRODUKTE
CHEMICAL PRODUCTS
CHEMISCHE PRODUKTEN
PRODUITS CHIMIQUES

4



LEDER
LEATHER
LEDER
CUIR

5



WERKSTATTEINRICHTUNGEN
WORK SHOP FURNISHING
WERKPLAATSINRICHTING
ÉQUIPEMENT D'ATELIER

6



FT[®]
international.com

MASCHINEN UND ZUBEHÖR
MACHINERY AND ACCESSORIES
MACHINES EN TOEBEHOREN
MACHINES ET ACCESSOIRES

7



EINZELHANDEL
RETAIL
WEDERVERKOOP
ARTICLES DE REVENTE

8



WERKZEUGEN UND KLEINMASCHINEN
TOOLS AND SMALL MACHINERY
GEREEDSCHAPPEN EN KLEINE MACHINES
OUTILS ET PETITES MACHINES

9



BESCHLÄGE, SCHLÜSSEL UND ZUBEHÖR
METAL HARDWARE, KEYS AND ACCESSORIES
METAALWAREN, SLEUTELS EN TOEBEHOREN
QUINCAILLERIE, GLÉS ET ACCESSOIRES

10



GRÖSSENTABELLE
SIZES
MATENTABEL
GABARITS

11



AFT INTERNATIONAL | BELGIUM



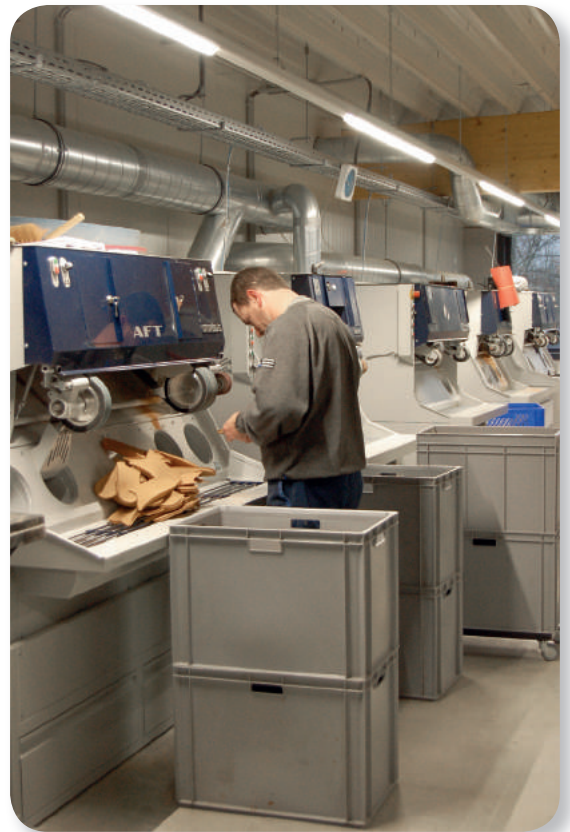

PLATTENMATERIAL
SHEET MATERIAL
PLAATMATERIAAL
PLAQUES



AFT[®]
AFT-International.com

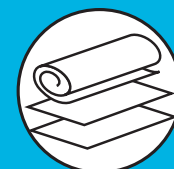

1.01	GUMMI RUBBER RUBBER CAOUTCHOUC	1.2
1.02	MIKRO ZELLULARGUMMI MICRO CELLULAR RUBBER MICRO CELLULAIRE RUBBER CAOUTCHOUC MICRO CELLULAIR	1.8
1.03	EVA	1.10
1.04	POLYETHYLEN-SCHAUMSTOFF POLYETHYLENE-FOAM POLYETHYLEEN SCHUIMSTOF MOUSSE POLYÉTHYLÈNE	1.18
1.05	CADCAM FRÄSMATERIALIEN MILLING MATERIALS FREESMATERIALEN MATÉRIAUX À FRAISER	1.20
1.06	KORK CORK KURK LIÈGE	1.26
1.07	VERSTEIFUNGSSTOFFE STIFFENING TISSUES VERSTIJVINGSSTOFFEN TOILES THERMOCOLLANTES	1.30
1.08	STOSSDÄMPFENDE MATERIALIEN SHOCKABSORBING MATERIAL SCHOKABSORBERENDE MATERIALIEN MATERIAUX ABSORBANT DE CHOC	1.34
1.09	LAMINATEN LAMINATES LAMINATEN LAMINAGES	1.40
1.10	BRANDSOHLENMATERIAL MATERIAL FOR BASE SOLES MATERIAAL VOOR GRONDPATRONEN MATÉRIAUX POUR PREMIÈRES	1.42
1.11	VAKUUMTECHNIK VACUUM TECHNICS VACUÛMTECHNIEK TECHNIQUE PNEUMATIQUE	1.43
1.12	THERMOPLASTEN THERMOPLASTS THERMOPLASTEN THERMOPLASTIQUES	1.44
1.13	SYNTHETISCHE BEZUGSSTOFFE SYNTHETIC TISSUES SYNTHETISCHE BEKLEDINGSSTOFFEN TISSUES SYNTHÉTIQUES	1.46
1.14	RAHMEN WELTS RANDEN TRÉPOINTES	1.54

1.01

GUMMI
RUBBER
RUBBER
CAOUTCHOUC

VULKOLAN VKL 1308.



50 x 50cm

Sehr abriebfest (DIN 60), ideal für Damenflecke
Very good abrasion resistance (DIN 60), ideal for ladies' heels
Zeer slijtvast (DIN 60), ideaal voor dameshakken
Très bonne résistance à l'abrasion, idéal pour les talons dames

Shore A80

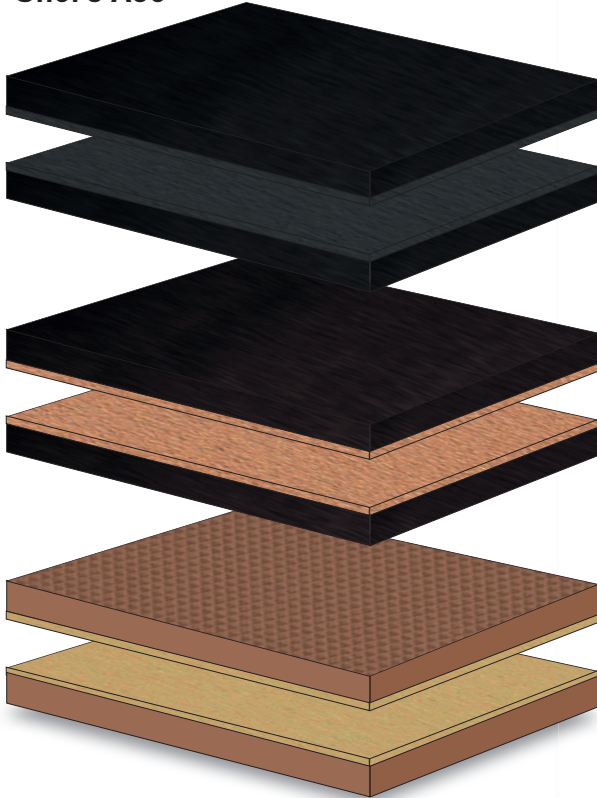

			0	1	4
0	VKL glatt smooth glad lisse + Gummi rubber caoutchouc	4,5 mm 1,2 mm	•	•	
1	VKL glatt smooth glad lisse + Leder leather leder cuir	4,5 mm 1,2 mm	•	•	
5	VKL Diamant + Gummi rubber caoutchouc	4,5 mm 1,2 mm	•	•	•

Wir liefern Ihnen diese Platten auch gestanzt in jeder Größe.
We supply all these materials cut in all different sizes.
Deze platen kunnen gestanst worden in alle mogelijke modellen.
Nous fournissons ces plaques dans chaque modèle découpé.

VULKOSVIG 130890.



24 x 31cm

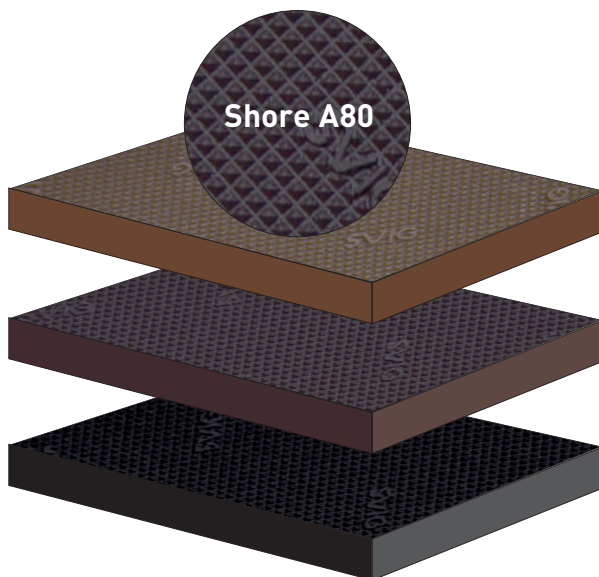

		0	1	7
6 mm		•	•	•

Farbabweichungen zwischen dem Farbdruck und dem Originalprodukt sind möglich.
Colour differences between print and original product are possible.
Kleurverschillen tussen het drukwerk en het origineel product zijn mogelijk.
Des différences de couleur entre l'imprimerie et la produit originale sont possible.



CROWN 1303.



Abrieb DIN 180
Abrasion DIN 180
Slijtweerstand DIN 180
Abrasion DIN 180

100 x 50cm

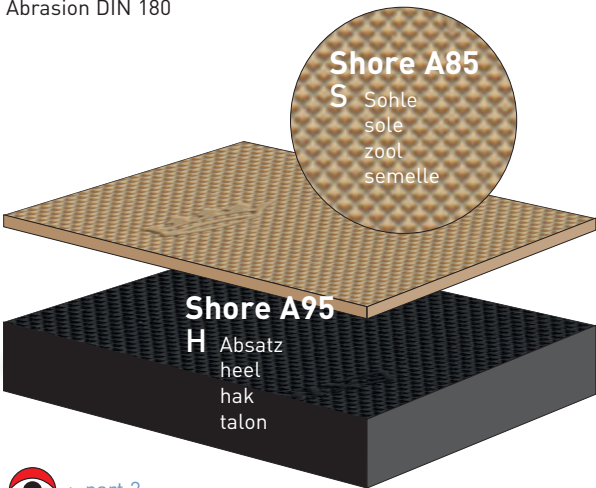

Wir liefern Ihnen diese Platten auch gestanzt in jeder Größe.
We supply all these materials cut in all different sizes.
Deze platen kunnen gestanst worden in alle mogelijke modellen.
Nous fournissons ces plaques dans chaque modèle découpé.

		0	1	4
18	1,8 mm S	•	•	•
25	2,5 mm S	•	•	•
30	3 mm S	•	•	
35	3,5 mm S	•	•	
40	4 mm S	•	•	
50	5 mm S	•		
60	6 mm H	•	•	•
80	8 mm H		•	
99	10 mm H		•	

DUO-TOP 1305.



Kombination von 2 verschiedene Gummi: härtere formfeste Unterschicht, weiche aber sehr abriebfeste Oberschicht.

63 x 73cm

Combination of 2 rubbers: harder bottom layer which is retaining his shape, softer but strong abrasion resistant top layer.

Combinatie van 2 rubbers: hardere vormvaste onderlaag, zachte uiterst sterke slijtvaste toplaag.

Combinaison de 2 caoutchouc: base dur pour stabiliser la forme, dessus mou, flexible et extrêmement solide.



		0	1	7
18	1,8 mm S	•	•	•
25	2,5 mm S	•		
35	3,5 mm S	•	•	
60	6 mm H	•	•	•

Oberschicht in 1,8 mm auch separat zur Verfügung als Sohlenmaterial.

Top layer is also separate available in 1,8 mm for soles.

Toplaag is ook apart verkrijgbaar als zolenmateriaal in 1,8 mm dikte.

Le dessus est également disponible en 1,8 mm comme matériel de ressemelage.



VULKOLAN, VULKOSVIG, CROWN, DUO-TOP

0	1	4	7
schwarz black zwart noir	braun brown bruin brun	beige	karamell toffee karamel caramel

GUM-TOP 1335.



57 x 90cm



		0	1
60	6 mm H	•	•



SEBAGO 13061.



73 x 63cm



		0	1	6	7
40	4 mm	•	•	•	•
60	6 mm	•	•		•

COMPACT RUBBER 13091.



100 x 50cm

Beidseitig aufgerauht; Ideales Zwischensohlenmaterial zum Nähen
Sanded on both sides; Ideal innersole material for stitching
Geruwd langs beide zijden; Ideaal door te naaien tussenzool materiaal
Cardé deux faces; Intercalaire idéale pour coudre à la machine

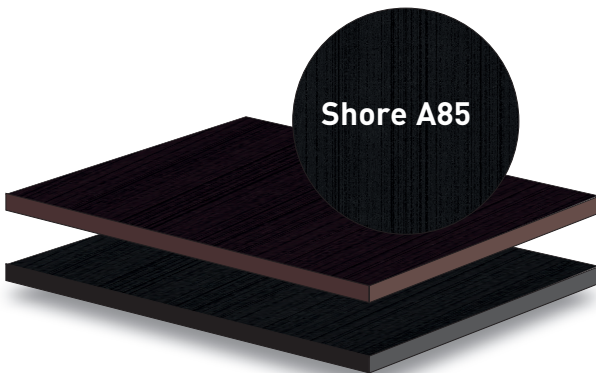

		181	146
		schwarz black zwart noir	dunkelbraun dark brown donkerbruin brun foncé
25	2,5 mm	•	•

GUM-TOP, SEBAGO, RUGUEUX,
RASTRE, MEXICO DIAMANTINO, DIAMANTINO FINE,
CROSS, WAVE, HEAVY GRIP



0	1	4	5	6	7
schwarz black zwart noir	braun brown bruin brun	beige	dunkelblau dark blue donkerblauw bleu foncé	weiß white wit blanc	karamell toffee karamel caramel



> part 11

Grössentabelle
Sizes
Matentabel
Gabarits

Wir liefern Ihnen diese Platten auch gestanzt in jeder Größe.
We supply all these materials cut in all different sizes.
Deze platen kunnen gestanst worden in alle mogelijke modellen.
Nous fournissons ces plaques dans chaque modèle découpé.



RUGUEUX 13063.



1

73 x 63cm

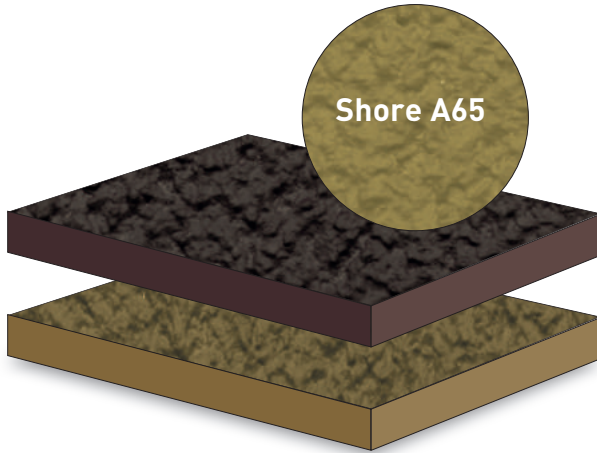

Shore A65

		0	1	4	7
30	3 mm	•	•	•	•
40	4 mm	•	•	•	•
50	5 mm	•			
60	6 mm	•	•	•	•

RASTRE 13065.



1

73 x 63cm



> part 2

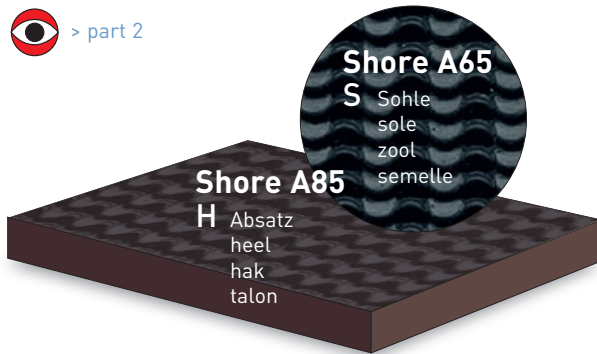

Shore A65

S Sohle
sole
zool
semelle

Shore A85

H Absatz
heel
hak
talon

		0	1	4	7
40	4 mm S	•	•	•	•
60	6 mm S	•	•	•	•
60H	6 mm H	•	•		

MEXICO DIAMANTINO 13208.



1

73 x 63cm

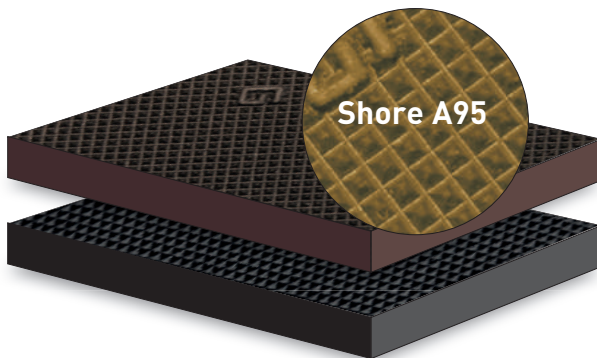

Shore A95

		0	1	7
60	6 mm	•	•	•

DIAMANTINO FINE 13207.5.



1

73 x 63cm

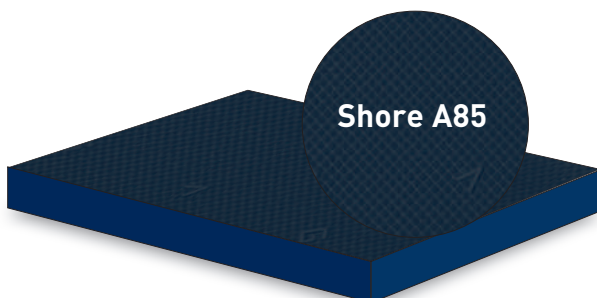

Shore A85

		5	
18	1,8 mm	•	
60	6 mm	•	

Farbabweichungen zwischen dem Farbdruck und dem Originalprodukt sind möglich.
Colour differences between print and original product are possible.
Kleurverschillen tussen het drukwerk en het origineel product zijn mogelijk.
Des différences de couleur entre l'imprimerie et la produit originale sont possible.

1.01

GUMMI
RUBBER
RUBBER
CAOUTCHOUC

CROSS 1301.



63 x 73cm

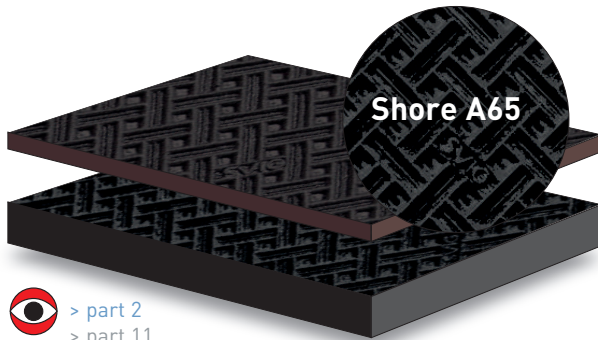

> part 2
> part 11

		0	1	7
40	4 mm	•	•	•
60	6 mm	•	•	•

WAVE 1302.



63 x 73cm

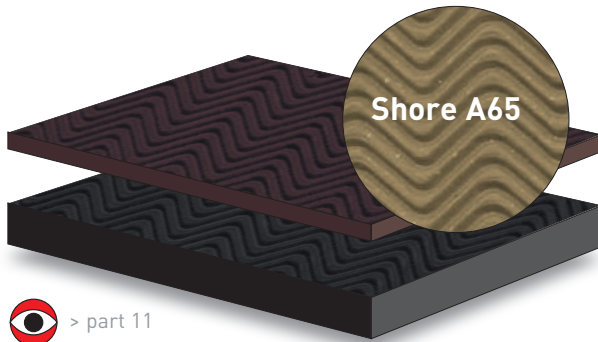

> part 11

		0	1	7
20	2 mm	•	•	•
60	6 mm	•	•	•

HEAVY GRIP 1307.



63 x 73cm



> part 11

		0	1
40	4 mm	•	•
60	6 mm	•	•

HEXA-4-GRIP 1311.



61 x 111cm

Speziell für Arbeitsschuhe entwickelt worden. Antistatisch, öl-, benzin- und säurebeständiges Gummi
Specially developed for work shoes. Antistatic and oil, fuel and acid resistant rubber
Speciaal ontwikkeld voor werkschoenen. Antistatisch, olie-, brandstof en zuurbestendig rubber
Spécialement développé pour des chaussures de travail. Qualité de caoutchouc antistatique et résistant aux huiles, carburants et acides

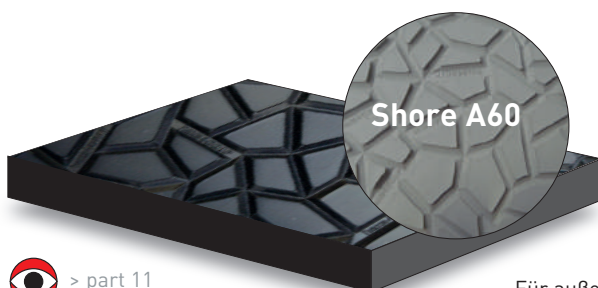

> part 11

NEU
NEW
NIEUW
NOUVEAU

		00	02
		black	grey
45	4,5 mm	•	•
60	6 mm	•	

Für außergewöhnliche Rutschfestigkeit durch PFI und TÜV geprüft und genehmigt.
Tested and approved by TÜV and PFI for its extraordinary slip resistance.
Getest en goedgekeurd door PFI en TÜV voor zijn buitengewone antislip.
Testé et approuvé par TÜV et PFI pour son anti-glisserment extraordinaire.



CREPINA SOFT 7107.



Laufsohlenplatte mit Krepp-Profil, weich; sehr abriebfest DIN 160, Dichte 1,12 Gr/cm³ 92 x 86cm
 Rubber solesheet, soft, profile crêpe; very good abrasion resistance DIN 160, Density 1,12 gr/cm³
 Loopzolenplaat in zacht rubber, met crêpe-profiel; zeer goede slijtvastheid DIN 160, dichtheid 1,12 g/cm³
 Plaque à semelles en caoutchouc souple, avec profil crêpe; très bonne résistance à l'abrasion DIN 160, densité 1,12 gr/cm³

CREPINA HARD 7108.



Absatzplatte mit Krepp-Profil, hart; sehr abriebfest DIN 200, Dichte 1,12 Gr/cm³ 92 x 86cm
 Rubber heelsheet, hard, profile crêpe; very good abrasion resistance DIN 200, Density 1,12 gr/cm³
 Hakkenplaat in hard rubber, met crêpe-profiel; zeer goede slijtvastheid DIN 200, dichtheid 1,12 g/cm³
 Plaque à talons en caoutchouc dur, avec profil crêpe; très bonne résistance à l'abrasion DIN 200, densité 1,12 gr/cm³

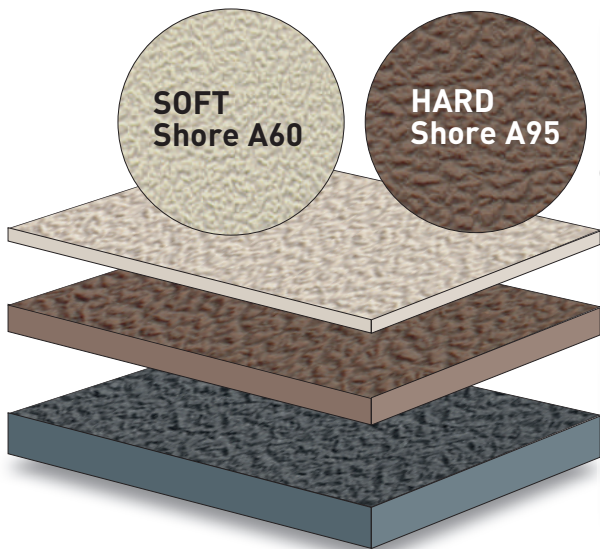

		CREPINA SOFT 7107			CREPINA HARD 7108
			181	146	
		in 16 Farben all 16 colours alle 16 kleuren les 16 couleurs	schwarz black zwart noir	braun brown bruin brun	in 16 Farben all 16 colours alle 16 kleuren les 16 couleurs
02	2 mm	•	•	•	
03	3 mm		•	•	
04	4 mm	•	•	•	
05	5 mm		•	•	
06	6 mm	•	•	•	•

> part 2
> part 11

Wir liefern Ihnen diese Platten auch gestanzt in jeder Größe.
 We supply all these materials cut in all different sizes.
 Deze platen kunnen gestanzt worden in alle mogelijke modellen.
 Nous fournissons ces plaques dans chaque modèle découpé.

CREPINA SOFT,
CREPINA HARD

109	111	166	197	181	105	189	187
weiß white wit blanc	hellgrau light grey lichtgrijs gris clair	mittelgrau medium grey middelgrijs gris moyen	dunkelgrau dark grey donkergrijs gris foncé	schwarz black zwart noir	hellbeige light beige lichtbeige beige clair	arena	tierra
135	185	122	198	146	106	178	159
beige	taupe antelope leverbeige gabardine	hellbraun light brown lichtbruin brun clair	otter	dunkelbraun dark brown donkerbruin brun foncé	rot red rood rouge	dunkelblau dark blue donkerblauw bleu foncé	dunkelgrün dark green donkergroen vert foncé

Farbabweichungen zwischen dem Farbdruck und dem Originalprodukt sind möglich.
 Colour differences between print and original product are possible.
 Kleurverschillen tussen het drukwerk en het origineel produkt zijn mogelijk.
 Des différences de couleur entre l'imprimerie et la produit originale sont possible.

1.02

MIKRO ZELLULARGUMMI
 MICRO CELLULAR RUBBER
 MICRO CELLULAIRE RUBBER
 GAOUTCHOUC MICRO CELLULAIRE

SUPRALITE 1325.



110 x 75cm

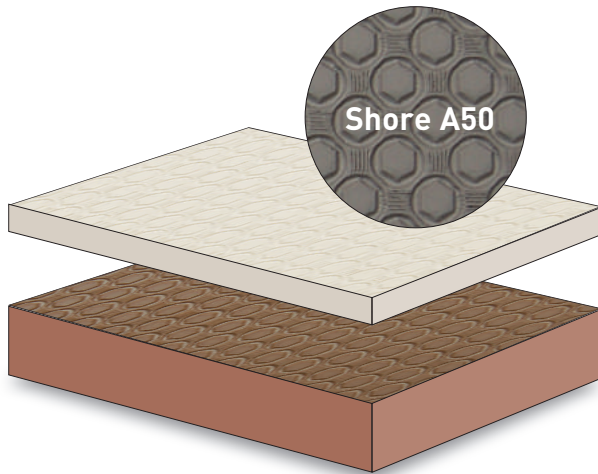

		*	
		in 7 Farben in 7 colours in 7 kleuren en 7 couleurs	
04	4 mm	●	
06	6 mm	●	
08	8 mm	●	
10	10 mm	●	

ZEPHIR TRIANGLE 1323.



89 x 71cm

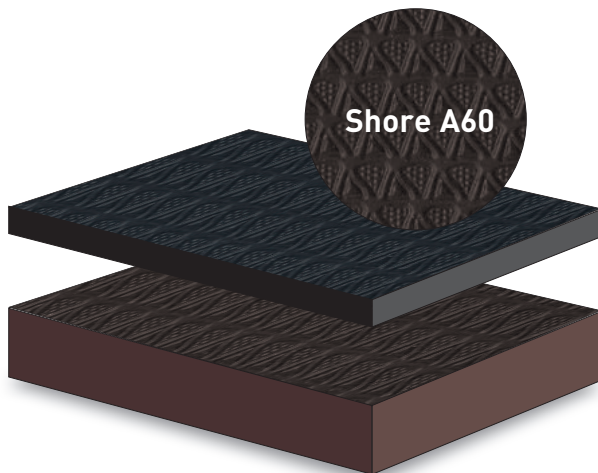

		181	146
		schwarz black zwart noir	dunkelbraun dark brown donkerbruin brun foncé
04	4 mm	●	●
06	6 mm	●	●
08	8 mm	●	●
10	10 mm	●	●

ZEPHIR SHELL 1322.



89 x 71cm

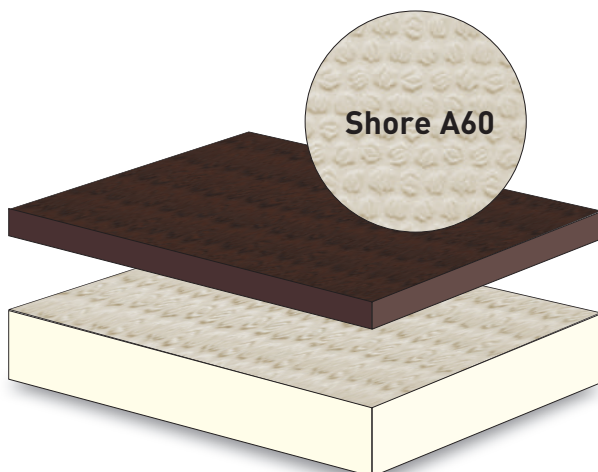

		181	146	109
		schwarz black zwart noir	dunkelbraun dark brown donkerbruin brun foncé	weiß white wit blanc
04	4 mm	●	●	●
06	6 mm	●	●	●
08	8 mm	●	●	●
10	10 mm	●	●	●

Reiner expandierter Gummi, Gleitschutz, guter abriebwert DIN 180-220, Dichte 0,50 Gr/cm³
 Pure expanded rubber, antiskid, good abrasion resistance DIN 180-220, density 0,50 gr/cm³
 Zuiver geëxpandeerde rubber, antislip, goede slijtweerstand DIN 180-220, dichtheid 0,50 g/cm³
 Caoutchouc pur expansé, antidérapant, bonne résistance à l'abrasion DIN 180-220, densité 0,50 gr/cm³



NOPAIR-BT 7103.



1
110 x 75cm

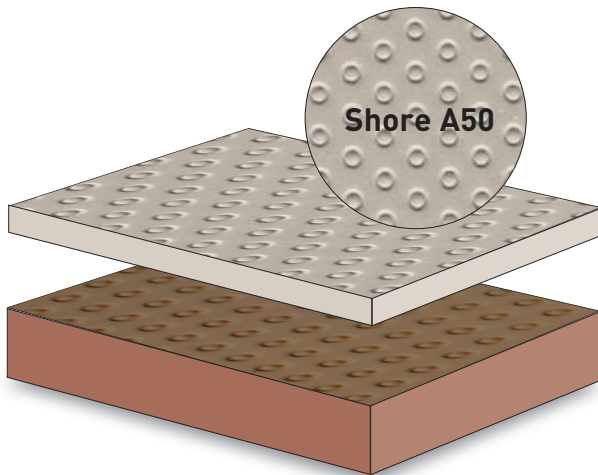

in 16 Farben
all 16 colours
alle 16 kleuren
toutes les 16 couleurs

04	4 mm	●
06	6 mm	●
08	8 mm	●
10	10 mm	●

> part 11

**Wir liefern Ihnen diese Platten auch gestanzt in jeder Größe.
 We supply all these materials cut in all different sizes.
 Deze platen kunnen gestanst worden in alle mogelijke modellen.
 Nous fournissons ces plaques dans chaque modèle découpé.**



SUPRALITE*, ZEPHIR, NOPAIR

109	111	166	197	181	105	189	187
weiß white wit blanc	hellgrau light grey lichtgrijs gris clair	mittelgrau medium grey middelgrijs gris moyen	dunkelgrau dark grey donkergrijs gris foncé	schwarz black zwart noir	hellbeige light beige lichtbeige beige clair	arena	tierra
135	185	122	198	146	106	178	159
beige	taupe antelope leverbeige gabardine	hellbraun light brown lichtbruin brun clair	otter	dunkelbraun dark brown donkerbruin brun foncé	rot red rood rouge	dunkelblau dark blue donkerblauw bleu foncé	dunkelgrün dark green donkergroen vert foncé

Farbabweichungen zwischen dem Farbdruck und dem Originalprodukt sind möglich.
 Colour differences between print and original product are possible.
 Kleurverschillen tussen het drukwerk en het origineel product zijn mogelijk.
 Des différences de couleur entre l'imprimerie et le produit originale sont possible.

SUPERSOFTAIR 7101.

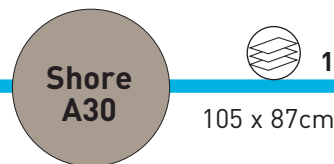

Zwischensohlenmaterial, glatt, leicht, weich und elastisch.
 Innersole material, soft, light and elastic.
 Tussenzoolmateriaal, extra licht, zacht en veerkrachtig.
 Plaque à semelles intercalaire, extra-légère, douce et très élastique.

SOFTAIR 7102.

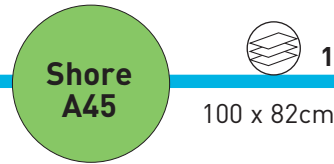

Zwischensohlenmaterial, glatt, geschliffen und flexibel; Dichte 0,20 Gr/cm³
 Innersole material, soft, smooth, sanded; density 0,20 gr/cm³
 Tussenzoolmateriaal, zacht en glad geschuurd; dichtheid 0,20 g/cm³
 Plaque à semelles intercalaire, souple, lisse et cardée; densité 0,20 gr/cm³

HARDAIR LIGHT 7104.

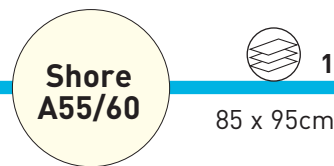

Zwischenmaterial für Absätze, glatt, geschliffen und hart; Dichte 0,28 Gr/cm³ - sehr leicht!
 Innerheel material, hard, smooth, sanded; density 0,28 gr/cm³ - extra light!
 Hard en glad tussenbouwmaterial voor hakken; dichtheid 0,28 g/cm³ - extra licht!
 Plaque à talons intercalaire, dure, lisse et cardée; densité 0,28 gr/cm³ - très léger!



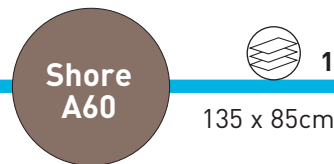



HARDAIR 7105.

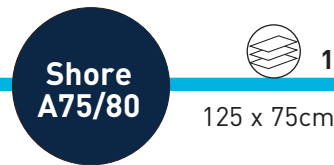

Zwischenmaterial für Absätze, glatt, geschliffen und hart; Dichte 0,36 Gr/cm³
 Innerheel material, hard, smooth, sanded; density 0,36 gr/cm³
 Hard en glad tussenbouwmaterial voor hakken; dichtheid 0,36 g/cm³
 Plaque à talons intercalaire, dure, lisse et cardée; densité 0,36 gr/cm³

SUPERHARDAIR 7106.



		 SUPER SOFTAIR 7101	 SOFTAIR 7102	 HARDAIR LIGHT 7104	 HARDAIR 7105	 SUPER HARDAIR 7106
			+pistache			
		in 16 Farben all 16 colours alle 16 kleuren les 16 couleurs	in 16 Farben all 16 colours alle 16 kleuren les 16 couleurs	109 146 181	in 16 Farben all 16 colours alle 16 kleuren les 16 couleurs	in 16 Farben all 16 colours alle 16 kleuren les 16 couleurs
	015 1,5 mm	•	•		•	
	02 2 mm	•	•	•	•	
	04 4 mm	•	•	•	•	
	05 5 mm	•	•	•	•	
	06 6 mm	•	•	•	•	
	08 8 mm	•	•	•	•	
	10 10 mm	•	•	•	•	
	12 12 mm	•	•	•	•	•
	15 15 mm	•	•	•	•	
	20 * 20 mm	•	•	•	•	
	24 24 mm			•	•	
	30 * 30 mm	•	•	•		



KEILE
STRIPES
KEILEN
BANDES BISEAUTÉES

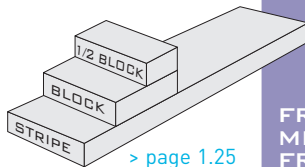

> page 1.25



FRÄSTECHNIK
MILLING TECHNIQUES
FREESTECHNIEK
TECHNIQUES À FRAISER



> page 3.4 - 3.13

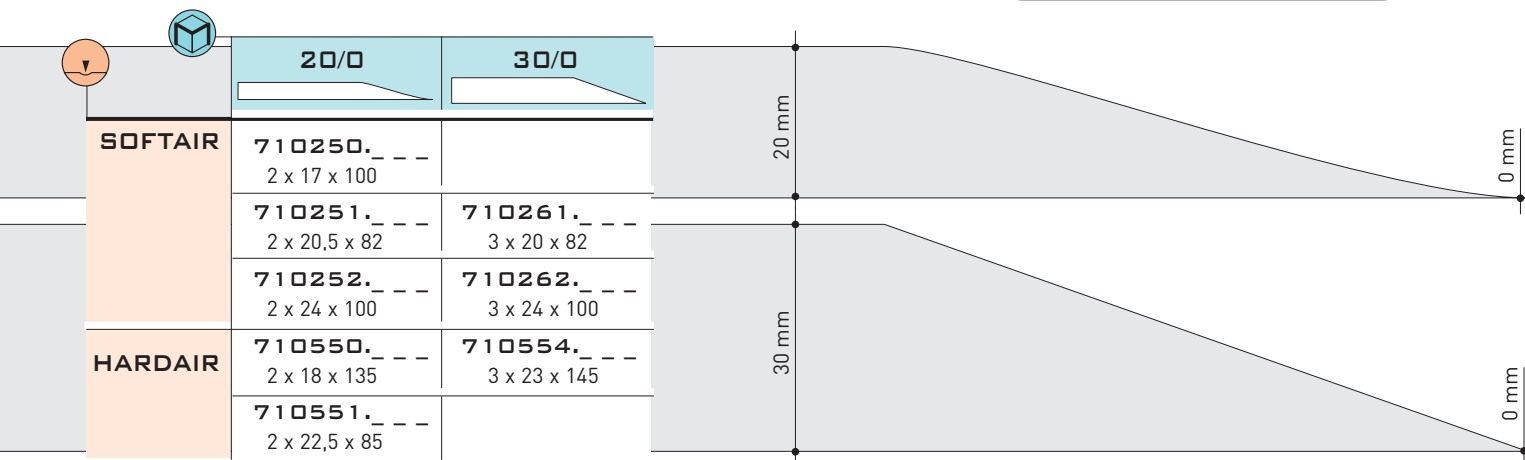

CUNA HARDAIR CUNA HARDAIR LIGHT



	30/0	23/3	30/0
146	7105730.46.D or H 2 x 17 x 100	7104723.46 D or H 3 x 20 x 82	7105730.46 D or H 2 x 24 x 100
181	7105730.81.D or H 2 x 20,5 x 82	7104723.81 D or H 3 x 24 x 100	7105730.81 D or H 2 x 18 x 135
109		7104723.09 D or H 2 x 22,5 x 85	
126		7104723.26 D or H 3 x 23 x 145	
179		7104723.79 D or H	

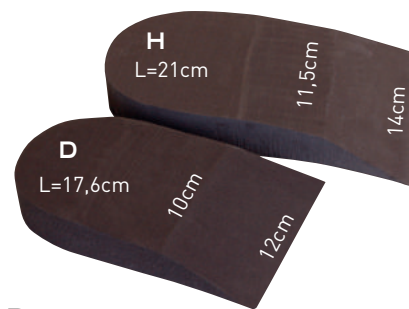

D Damen
women
dames
dames

H Herren
men
heren
hommes

SUPERSOFTAIR, SOFTAIR,
HARDAIR LIGHT, HARDAIR, SUPERHARDAIR, HARDAIR (LIGHT) CUNA

109	111	166	197	181	105	189	187	
weiß white wit blanc	hellgrau light grey lichtgrijs gris clair	mittelgrau medium grey middelgrijs gris moyen	dunkelgrau dark grey donkergrijs gris foncé	schwarz black zwart noir	hellbeige light beige lichtbeige beige clair	arena	tierra	
135	185	122	198	146	106	178	159	171
beige	taupe antelope leverbeige gabardine	hellbraun light brown lichtbruin brun clair	otter	dunkelbraun dark brown donkerbruin brun foncé	rot red rood rouge	dunkelblau dark blue donkerblauw bleu foncé	dunkelgrün dark green donkergroen vert foncé	pistache

Farbabweichungen zwischen dem Farbdruk und dem Originalprodukt sind möglich.
Colour differences between print and original product are possible.
Kleurverschillen tussen het drukwerk en het origineel product zijn mogelijk.
Des différences de couleur entre l'imprimerie et la produit originale sont possible.

Extrafoam

VORTEILE

- Sehr leichtes Material -
- Hervorragend geeignet zur thermischen Verformung von 90°C bis 120°C -
- Ideal für Orthesenbau, Fußbettungen und Einlagen -
- Nur geringe Schrumpfung -
- Langanhaltende, stossdämpfende Wirkung -
- Hautfreundlich -
- Sehr gutes Preis-/Leistungsverhältnis -

ADVANTAGES

- Very light material -
- Perfect for thermo moulding from 90°C to 120°C -
- Ideal for the construction of orthoses, insoles and orthopaedic foot supports -
- Light shrinkage -
- Long shock absorbing effect -
- Skin friendly -
- Perfect balance between price and quality -

VOORDELEN

- Zeer licht materiaal -
- Extreem goed thermisch vervormbaar tussen 90°C en 120°C -
- Ideaal voor orthesenbouw en voetbedden alsook steunzolen -
- Lichte krimp -
- Langdurige schokabsorberende werking -
- Huidvriendelijk -
- Perfecte prijs/kwaliteitsverhouding -

LES AVANTAGES

- Matériel très léger -
- Idéal pour thermoformage entre 90°C et 120°C -
- Spécifiquement pour la construction des orthèses et des semelles orthopédiques -
- Rétrécissement léger -
- Fonction antichoc longuement -
- Agréable pour la peau -
- Rapport parfait qualité-prix -

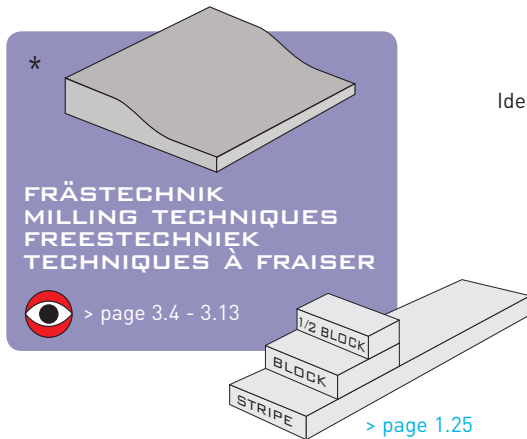

> part 11

**Wir liefern Ihnen diese Platten auch gestanzt in jeder Größe.
We supply all these materials cut in all different sizes.
Deze platen kunnen gestanst worden in alle mogelijke modellen.
Nous fournissons ces plaques dans chaque modèle découpé.**

**Alle anderen Stärken sind auf Anfrage lieferbar.
All other thicknesses can be delivered on request.
Alle andere diktes leverbaar op aanvraag.
D'autres épaisseurs livrables sur demande.**



EXTRAFOAM SOFT, MEDIUM, HARD

06	01	08	05	07	09
weiß white wit blanc	hautfarbe skin colour huidskleur couleur chair	königsblau royal blue koningsblauw bleu royal	dunkelblau dark blue donkerblauw bleu foncé	grün green groen vert	rot red rood rouge
SOFT MEDIUM	SOFT	MEDIUM	HARD		
00	17	04	10		
schwarz black zwart noir	grau grey grijs gris	gelb yellow geel jaune	violett violet violet violet		

Farbabweichungen zwischen dem Farbdruck und dem Originalprodukt sind möglich.
Colour differences between print and original product are possible.
Kleurverschillen tussen het drukwerk en het origineel product zijn mogelijk.
Des différences de couleur entre l'imprimerie et la produit originale sont possible.



EXTRAFOAM SOFT 7011.



Dichte 0,15 Gr/cm³
density 0,15 gr/cm³
dichtheid 0,15 g/cm³
densité 0,15 gr/cm³

105 x 95cm

EXTRAFOAM MEDIUM 7012.



Dichte 0,21 Gr/cm³
density 0,21 gr/cm³
dichtheid 0,21 g/cm³
densité 0,21 gr/cm³

110 x 95cm

EXTRAFOAM HARD 7013.



Dichte 0,38 Gr/cm³
density 0,38 gr/cm³
dichtheid 0,38 g/cm³
densité 0,38 gr/cm³

95 x 95cm

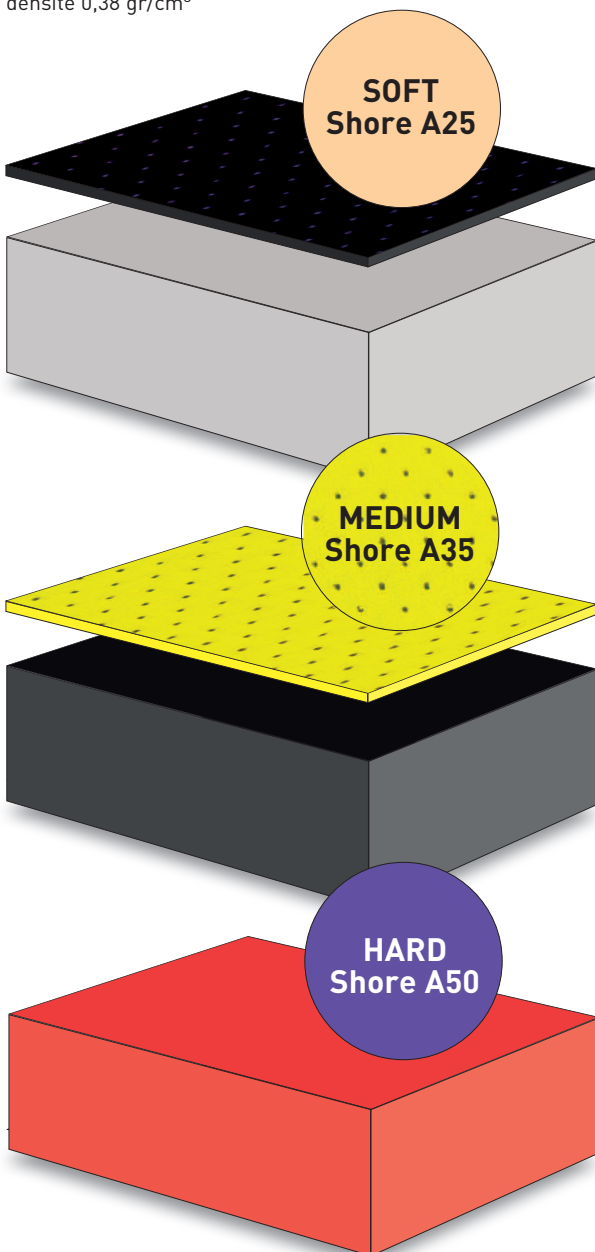

SOFT, MEDIUM, HARD

0	5
nicht perforiert not perforated niet geperforeerd non perforé	perforiert perforated geperforeerd perforé



Siehe Farbpalette
see color palette
zie kleurpalet
voir palette de couleurs



015	1,5 mm	•	•
02	2 mm	•	•
03	3 mm	•	•
04	4 mm	•	•
05	5 mm	•	•
06	6 mm	•	•
07	7 mm	•	
08	8 mm	•	
10	10 mm	•	
12	12 mm	•	
15	15 mm	•	
20	20 mm	•	
25	25 mm	•	
30 *	30 mm	•	

EXTRAFOAM MULTICOLOR 7014.

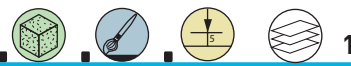

105 x 90cm

Dichte 0,20 Gr/cm³
density 0,20 gr/cm³
dichtheid 0,20 g/cm³
densité 0,20 gr/cm³

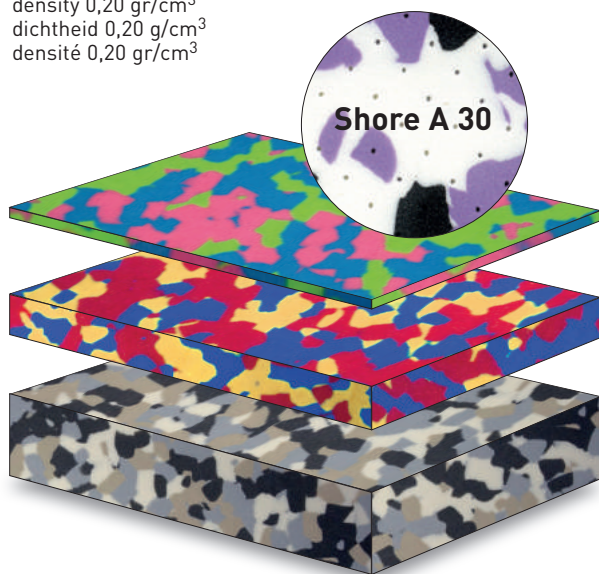

11	12	14	15
+ black + white + purple	+ red + green + white + purple	+ blue + red + yellow + white+black	+ black + white
16	18	19	
+ fuchsie + turquoise + pistache	+ grey + tierra + eggshell	+ orange + blue + red	

EXTRAFOAM AQUA 7014.



105 x 90cm

Dichte 0,20 Gr/cm³
density 0,20 gr/cm³
dichtheid 0,20 g/cm³
densité 0,20 gr/cm³

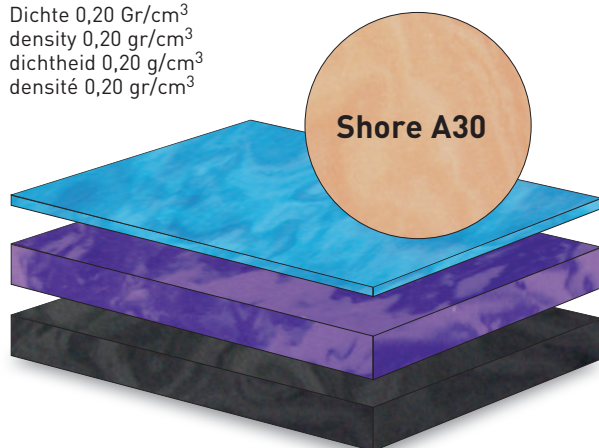

30	31	32	33
blau blue blauw bleu	beige	schwarz black zwart noir	purpur purple purper pourpre

EXTRAFOAM MARBLE 7014.



105 x 90cm

Dichte 0,20 Gr/cm³
density 0,20 gr/cm³
dichtheid 0,20 g/cm³
densité 0,20 gr/cm³

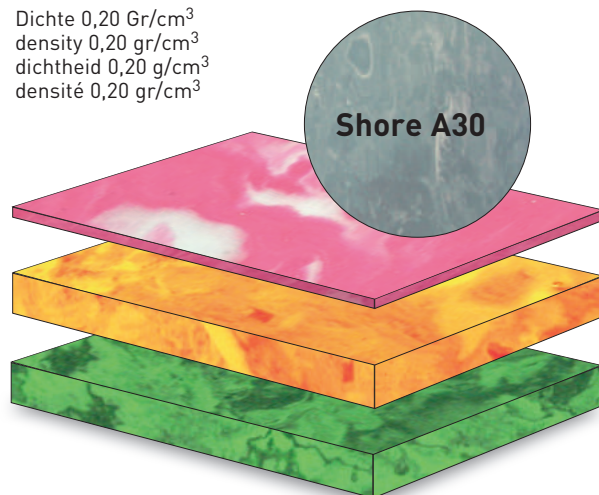

35	36	37	38
blau blue blauw bleu	grün green groen vert	orange orange oranje orange	rosa pink roze rose



EXTRAFOAM MULTICOLOR, AQUA, MARBLE



0	5
nicht perforiert not perforated niet geperforeerd non perforé	perforiert perforated geperforeerd perforé

015>06	1,5 > 6 mm	●	●
07>25	7 > 25 mm	●	
30*	30 mm	●	



> part 11

**Wir liefern Ihnen diese Platten auch gestanzt in jeder Größe.
We supply all these materials cut in all different sizes.
Deze platen kunnen gestanst worden in alle mogelijke modellen.
Nous fournissons ces plaques dans chaque modèle découpé.**

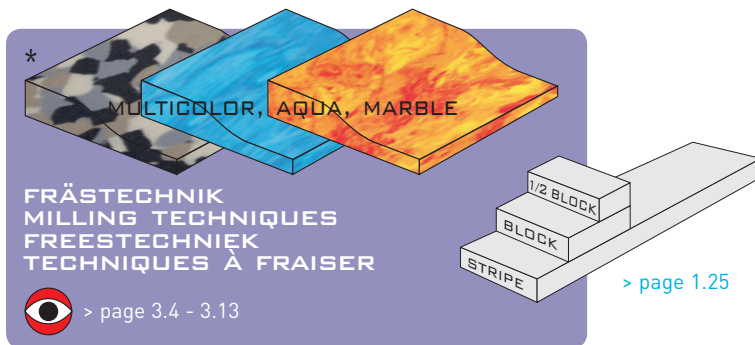

> page 3.4 - 3.13

EVA-MARBLE MINI-ROLLS 7162012. 1

110 x 12cm - 2mm



Farbabweichungen zwischen dem Farbdruck und dem Originalprodukt sind möglich.
Colour differences between print and original product are possible.
Kleurverschillen tussen het drukwerk en het origineel product zijn mogelijk.
Des différences de couleur entre l'imprimerie et la produit originale sont possible.

EXTRAGRIP 70150.



- Dichte/density/dichtheid/densité 0,16 Gr/cm³
- Gleitschutz/antiskid/antislip/antidérapant
- Extra elastisch/very Elastic/extra veerkrachtig/très élastique

100 x 100 cm

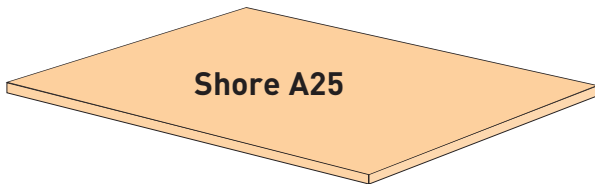

01
hautfarbe
skin colour
huidskleur
couleur chair

015 > 30 1,5 > 30 mm

ELASTOFLEX/HIGHFLEX 7016.



Sehr elastisches EVA Material, Elastoflex ist ideal für Diabetiker Einlagen, Highflex für Sport Einlagen.
EVA material with much higher elasticity, Elastoflex is ideal for diabetics, Highflex for sport orthosis.
EVA materiaal met hoge elasticiteit, Elastoflex is ideaal voor diabetici, Highflex voor sport steunzolen.
EVA avec beaucoup d'élasticité, Elastoflex est idéal pour diabétique, Highflex pour des semelles de sport.

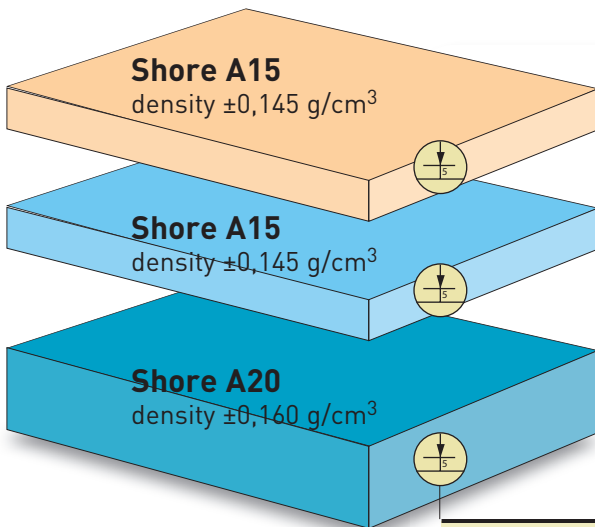

ELASTO-FLEX	HIGH-FLEX		
	15	20	25
±0,145 g/cm ³	±0,16 g/cm ³	±0,19 g/cm ³	
101	176	174	172
hautfarbe skin colour huidskleur couleur chair	l. blau l. blue l. blauw bleu clair	turquoise turkis	orange
02 > 40* 2 > 40 mm	100 x 120cm	100 x 120cm	110 x 92cm
		110 x 92cm	105 x 92cm

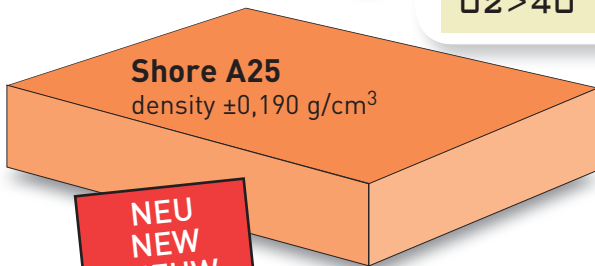

**NEU
NEW
NIEUW
NOUVEAU**

*** ELASTOFLEX
HIGHFLEX**

**FRÄSTECHNIK
MILLING TECHNIQUES
FREESTECHNIEK
TECHNIQUES À FRAISER**

> page 3.4 - 3.13

> part 11

Wir liefern Ihnen diese Platten auch gestanzt in jeder Größe.
We supply all these materials cut in all different sizes.
Deze platen kunnen gestanst worden in alle mogelijke modellen.
Nous fournissons ces plaques dans chaque modèle découpé.

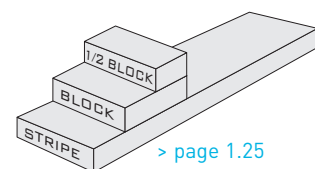



TERMOLAST 7008.



Ideal zur thermischen Verformung - Hohe Rückstellkraft, keine Schrumpfung - Sehr leicht zu schleifen
 Perfectly thermo mouldable - Returns to its original form, no shrinking - Very easy to grind
 Ideaal voor thermische vervorming - Zeer goede en langdurige veerkracht - Zeer makkelijk te schuren
 Idéal pour thermoformage - Revient dans sa forme originale, pas de rétrécissement - Facile à verrer

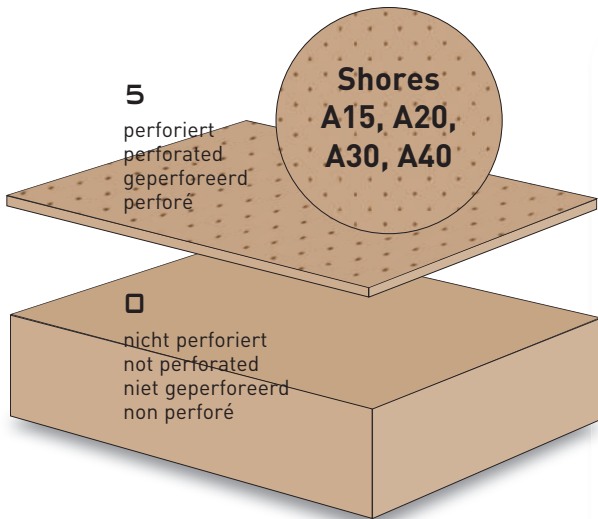

1

hautfarbe
 skin colour
 huidskleur
 couleur chair



115x115cm 100x75cm 105x87cm 100x82cm

15 20 30 40

A15**

sehr weich
 very soft
 zeer zacht
 très douce

A20**

sehr weich
 very soft
 zeer zacht
 très douce

A30

weich
 soft
 zacht
 douce

A40

hohe Stabilität
 very high stability
 zeer hoge stabiliteit
 très haute stabilité



0	5	015	1,5 mm		
		>	>		
		06	6 mm		•
		>	>		•
		08	8 mm		•
		>	>		•
		30*	30 mm		•



** Besonders geeignet für Diabetiker
 Especially for diabetics
 Zeer geschikt voor diabetici
 Spécialement pour diabétique

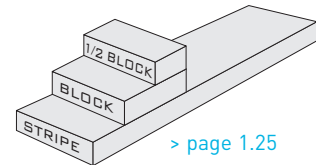

PODOTHERM 7010122.

Shore A50



130 x 80cm

VORTEILE

- Abriebwert DIN 100, Dichte 0,45 Gr/cm³
- Ideal zur thermischen Verformung bis 100°C
- Äußerst gute Stossdämpfung durch die ideale Mischung von -EVA und Kompaktgummi

ADVANTAGES

- Abrasion resistance DIN 100, density 0,45 gr/cm³
- Perfect for thermo moulding up to 100°C
- Shock absorbing due to the perfect mixture of EVA and Compact rubber

VOORDELEN

- Slijtweerstand DIN 100, dichtheid 0,45 g/cm³
- Zeer goed thermisch vervormbaar tot 100°C
- Zeer langdurige schokabsorberende werking, door de ideale EVA/compact rubber-mengeling

AVANTAGES

- Résistance à l'abrasion DIN 100, densité 0,45 gr/cm³
- Idéal pour thermoformage depuis 100°C
- Choc absorbant à cause du mélange parfait de EVA et Compact caoutchouc



dunkelbeige
 dark beige
 donkerbeige
 beige foncé



015	1,5 mm	•
02>08	2 > 8 mm	•
10	10 mm	•
15	15 mm	•
20	20 mm	•

Farbabweichungen zwischen dem Farbdruck und dem Originalprodukt sind möglich.
 Colour differences between print and original product are possible.
 Kleurverschillen tussen het drukwerk en het origineel product zijn mogelijk.
 Des différences de couleur entre l'imprimerie et la produit originale sont possible.

FORMLUX 7017.



110 x 110cm

- Dichte 0,14 Gr/cm³
- 100 % schrumpffrei bei Erwärmung bis 70°C; Verformungstemperatur bei ±130°C
- Anwendungsgebiet: Orthesenbau, Prothesenbau und Einlagen.
- Density 0,14 gr/cm³
- 100 % shrink resistance to heat by 70°C; thermo mouldable at ±130°C
- Used for construction of orthoses, prosthesis and orthopaedic foot supports.
- Dichtheid 0,14 g/cm³
- 100 % krimpvrij bij verwarming tot 70°C; vervormingtemperatuur bij ±130°C
- Toepassingsgebied: orthesenbouw, prothesenbouw en steunzolen.
- Densité 0,14 gr/cm³
- 100 % irrétrécissable pendant chauffage jusqu'à 70°C; temp. de thermoformage à ±130°C
- Pour la construction des orthèses, prothèses et semelles orthopédiques.

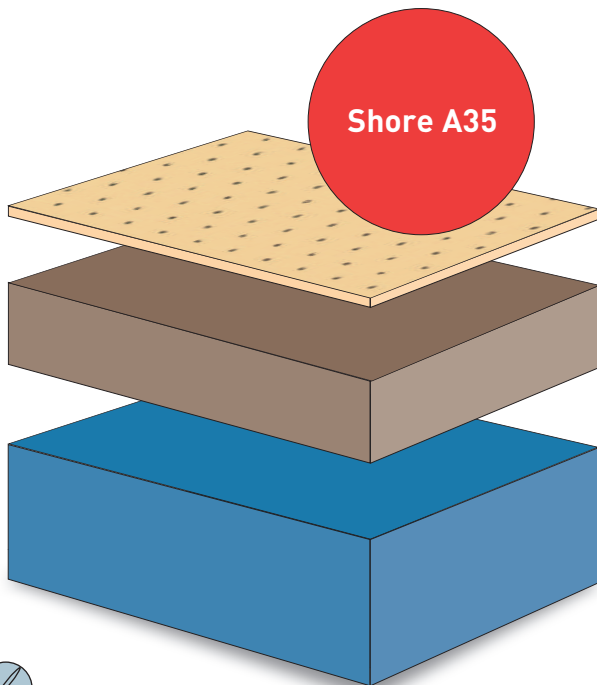

		0	5
		nicht perforiert not perforated niet geperforeerd non perforé	perforiert perforated geperforeerd perforé
		8 Farben 8 colours 8 kleuren 8 couleurs	8 Farben 8 colours 8 kleuren 8 couleurs
02	2 mm		
>	>	•	•
06	6 mm		
08	8 mm	•	
>	>	•	
36	36 mm		



06	01	02	04	07	08	09	00
weiß white wit blanc	hautfarbe skin colour huidskleur couleur chair	braun brown bruin brun	gelb yellow geel jaune	grün green groen vert	königsblau royal blue koningsblauw bleu royal	rot red rood rouge	schwarz black zwart noir

Farbabweichungen zwischen dem Farbdruck und dem Originalprodukt sind möglich.
 Colour differences between print and original product are possible.
 Kleurverschillen tussen het drukwerk en het origineel produkt zijn mogelijk.
 Des différences de couleur entre l'imprimerie et la produit originale sont possible.



Wir liefern Ihnen diese Platten auch gestanzt in jeder Größe.
 We supply all these materials cut in all different sizes.
 Deze platen kunnen gestanst worden in alle mogelijke modellen.
 Nous fournissons ces plaques dans chaque modèle découpé.

Alle anderen Stärken sind auf Anfrage lieferbar.
 All other thicknesses can be delivered on request.
 Alle andere diktes leverbaar op aanvraag.
 D'autres épaisseurs livrables sur demande.



EVAZOTE 7019.017.



Shore A10



200 x 100cm (grey)

PLASTAZOTE 7009.



Shore A15



200 x 100cm

- Dichte 0,045 Gr/cm³
- Verformungstemperatur bei ca. 160°C
- weltberühmtes Polstermaterial für Prothesen und Orthesen.
- density 0,045 gr/cm³
- Thermo mouldable at ca. 160°C
- World-famous padding material for prosthesis and orthoses.
- dichtheid 0,045 g/cm³
- Vervormingtemperatuur bij ca. 160°C
- Wereldberoemd polstermateriaal voor prothesen en orthesen.
- densité 0,045 gr/cm³
- Température de thermoformage à 160°C
- Matériel de rembourrage réputé dans le monde entier pour prothèses et orthèses.

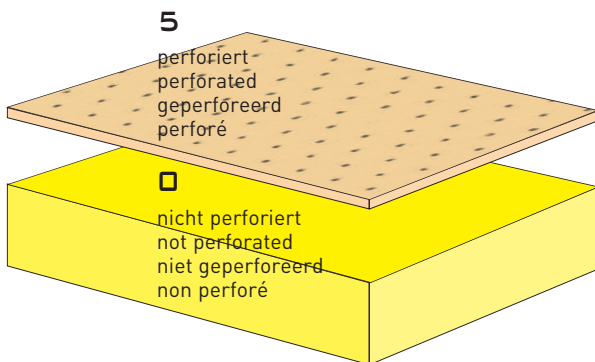

		PLASTAZOTE		EVAZOTE
		0	5	0
				17
		6 Farben 6 colours 6 kleuren 6 couleurs	6 Farben 6 colours 6 kleuren 6 couleurs	grau grey grijs gris
02	2 mm	•	•	•
03	3 mm	•	•	•
04	4 mm	•	•	•
05	5 mm	•	•	•
06	6 mm	•	•	•
08	8 mm	•		•
10	10 mm	•		•
12	12 mm	•		•
15	15 mm	•		•
20	20 mm	•		•
25	25 mm	•		
30	30 mm	•		•



EVAZOTE, PLASTAZOTE

06	01	04	08	09	00	17
weiß white wit blanc	hautfarbe skin colour huidskleur couleur chair	gelb yellow geel jaune	königsblau royal blue koningsblauw bleu royal	rot red rood rouge	schwarz black zwart noir	grau grey grijs gris

EVACAD 714



Shore	Density g/cm ³			015>20	30*	35*	40*
				1,5 > 20mm	30mm	35mm	40mm
25	±0,140		99x118 cm		09		09 87
30	±0,160		115x97cm		87 98	72 76	09 87 76 81 78 98
35	±0,185		107x92cm		09	15	09 78 81
40	±0,190		107x92cm		21 81 09	01 78 65	21 76 65 81 78 09 15
45	±0,230		104x90cm		28 71	46 28 09 81	46 28 71
50	±0,270		102x88cm		28 81 78 46	28 81	28 21 81 78 01 14 06
60	±0,370		90x80cm		46 78 81	85 29 76 78 85	
70	±0,425		84x74cm	81	81		

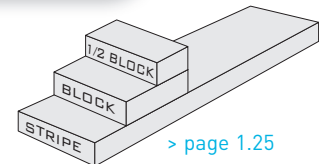
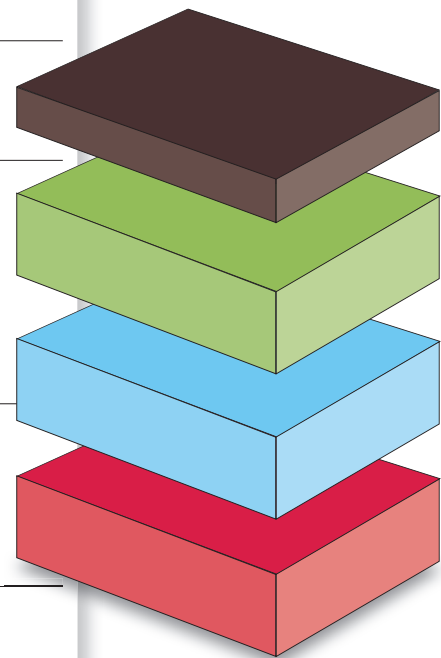

> page 1.25



EVACAD, EVASTAT

109	114	115	187	189	121	128	129	181
weiß white wit blanc	elfenbein ivory ivoor ivoir	beige beige beige beige	tierra	arena	hellgrau light grey lichtgrijs gris clair	dunkelgrau dark grey donkergrijs gris foncé	anthrazit anthracite antraciet anthracite	schwarz black zwart noir



EVASTAT 715.



Shore	Density g/cm ³	Icon	Dimensions	015 > 20	30 *	35 *	40 *
				1,5 > 20mm	30mm	35mm	40mm
30	±0,160	Icon	115 x 97cm	09	09	09	09
35	±0,185	Icon	110 x 95cm				81
40	±0,190	Icon	107 x 92cm			89	89
45	±0,230	Icon	104 x 90cm	09 81 87	09 81 87		09 81 87
50	±0,270	Icon	102 x 88cm				87 78
60	±0,370	Icon	93 x 82cm	09 81 87	09 81 87		

VORTEILE

- Besonderes geeignet für das CAD-CAM Fräsen von Einlagen auf grund seiner antidust Eigenschaft
- Staubpartikel laden sich nicht statisch auf (erhöht die Absaugkapazität)

ADVANTAGES

- Especially suitable for the CAD-CAM milling of orthopaedic foot supports due to its antidust characteristics
- No static loading of dust particles (eases the suction capacity)

VOORDELEN

- Uitermate geschikt voor het CAD-CAM freezen van steunzolen vanwege antidust eigenschappen
- Stofdeeltjes laden zich niet statisch op (vergemakkelijkt de afzuigcapaciteit)

LES AVANTAGES

- Hautement qualifié pour fraiser les semelles CAD-CAM à cause des caractéristiques 'antidust'
- Grain de poussière ne se charge pas statiquement (facilite la capacité d'aspiration)

*

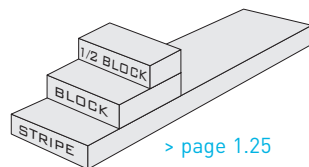

**Alle anderen Stärken sind auf Anfrage lieferbar.
All other thicknesses can be delivered on request.
Alle andere diktes leverbaar op aanvraag.
D'autres épaisseurs livrables sur demande.**

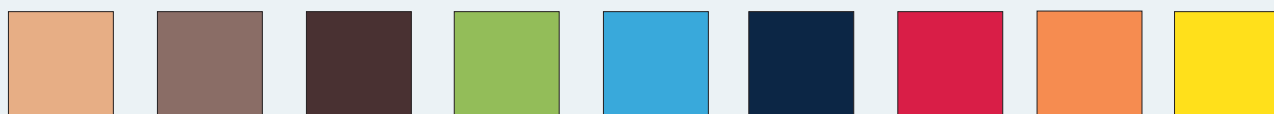

101 198 146 171 176 178 106 172 165

hautfarbe skin huidskleur couleur chair	otter otter loutre otter	dunkelbraun dark brown donkerbruin brun foncé	pistache	hellblau light blue lichtblauw bleu clair	dunkelblau dark blue donkerblauw bleu foncé	rot red rood rouge	orange orange oranje orange	gelb yellow geel jaune
--	-----------------------------------	--	----------	--	--	-----------------------------	--------------------------------------	---------------------------------

Farbabweichungen zwischen dem Farbdruck und dem Originalprodukt sind möglich.
Colour differences between print and original product are possible.
Kleurverschillen tussen het drukwerk en het origineel product zijn mogelijk.
Des différences de couleur entre l'imprimerie et le produit originale sont possible.

EVA CARBOSTAT 718.



Antistatisches Material ist perfekt geeignet für Arbeits- und Sicherheitsschuhe und entspricht folgende Anforderungen:
Antistatic material suitable for conductive footwear and safety shoes, meets following requirements:
Antistatisch materiaal geschikt voor werk- en veiligheidsschoenen, voldoet aan volgende normen:
Ce matériel antistatique est qualifié pour les chaussures de travail et chaussures de sécurité aux normes suivantes:

Electrical resistance of Conductive Footwear

DIN EN ISO 20345ff

- parameter: Electrical Resistance (3.14)
- Unit: Ohm
- Result: $3,0 \times 10^3$
- Requirement: $\leq 10^5$
- PFI report on request.

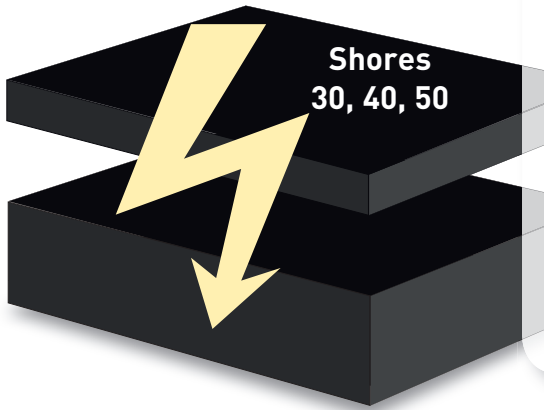

Shore	Density	Size	6	8	10	15	20	30*	40*
			6mm	8mm	10mm	15mm	20mm	30mm	40mm
30	±0,190	110x95cm	81	81	81	81	81		81
40	±0,270	105x90cm	81	81	81	81	81	81	81
50	±0,270	100x85cm	81	81	81	81	81		81

EVA MARBLE 716.



Shore	Density	Size	015	02	03	04	05	40*	
			1,5mm	2mm	3mm	4mm	5mm	38	32
40	±0,190	107x92cm						38	32
								45	48
								41	
50	±0,270	102x88cm	38	38	38	38	38	38	32
			45	45	45	45	45	45	

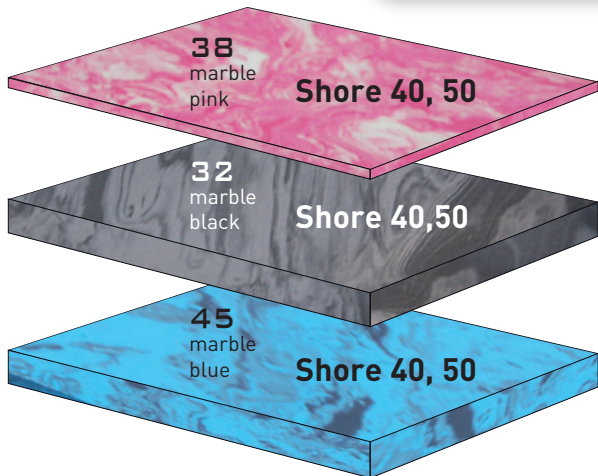

Alle anderen Stärken sind auf Anfrage lieferbar.
All other thicknesses can be delivered on request.
Alle andere diktes leverbaar op aanvraag.
D'autres épaisseurs livrables sur demande.

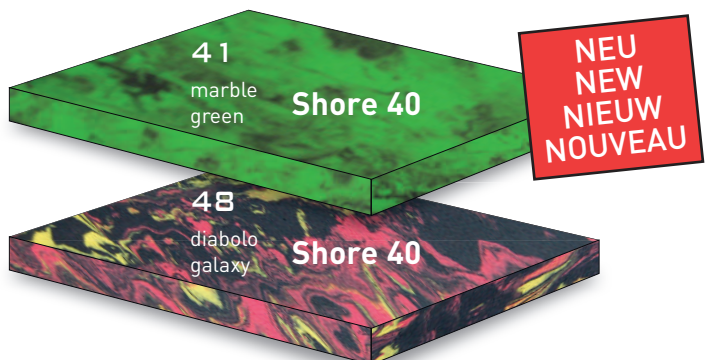



EVA CORK 717.000.

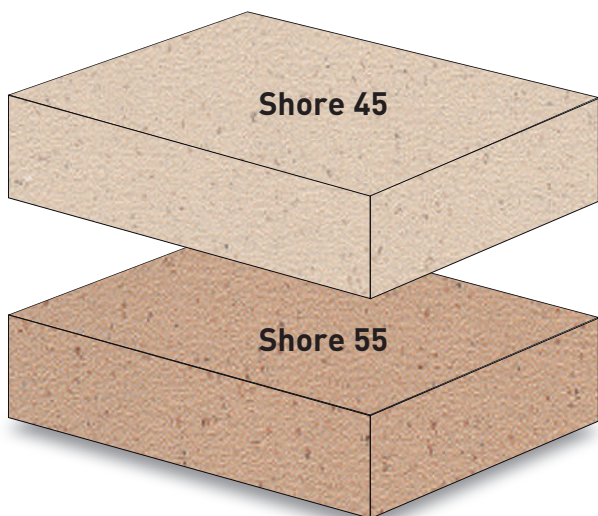

		45	55
		104x90cm	95x84cm
02	2 mm	•	•
03	3 mm	•	•
04	4 mm	•	•
05	5 mm	•	•
06	6 mm	•	•
08	8 mm	•	•
10	10 mm	•	•
12	12 mm	•	•
15	15 mm	•	•
20	20 mm	•	•
30*	30 mm	•	•
40*	40 mm	•	•

EVA CARBOSTAT, EVA MARBLE, EVA CORK

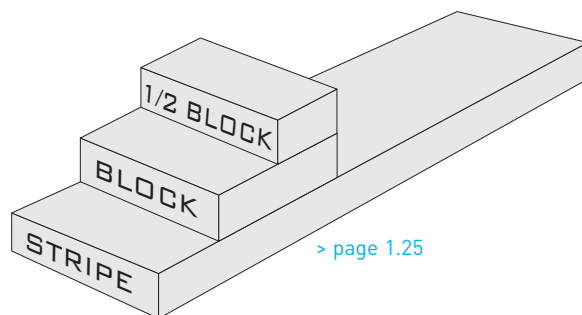
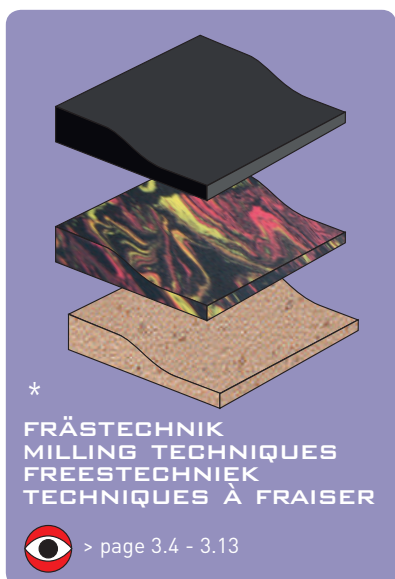

Farbabweichungen zwischen dem Farbdruck und dem Originalprodukt sind möglich.
 Colour differences between print and original product are possible.
 Kleurverschillen tussen het drukwerk en het origineel product zijn mogelijk.
 Des différences de couleur entre l'imprimerie et la produit originale sont possible.

KEILE
STRIPES
STROKEN
BANDES

BLOCK
BLOCK
BLOK
BLOC

1/2 BLOCK
1/2 BLOCK
1/2 BLOK
1/2 BLOC

 > part 1

UNI-FORM

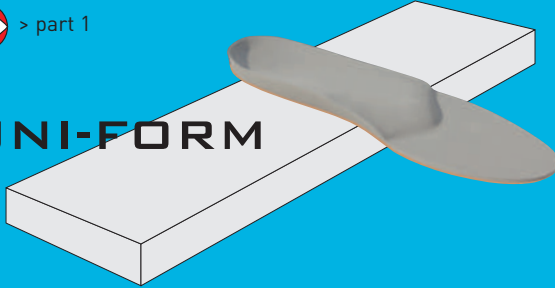

STANDARD*: 35 x 25 cm

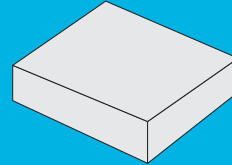

STANDARD*: 31 x 12,5 cm
35 x 13 cm

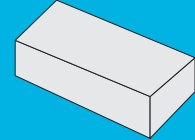

 > page 3.4 - 3.13

ORTHO-FORM



STANDARD*: 35 x 25 cm

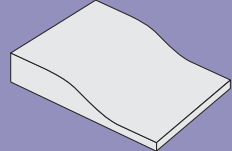

STANDARD*: 31 x 12,5 cm
35 x 13 cm

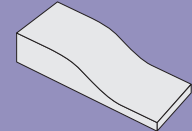

COMBI-FORM

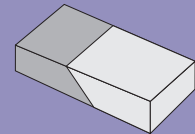
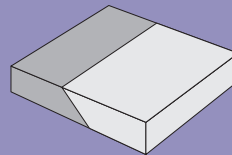
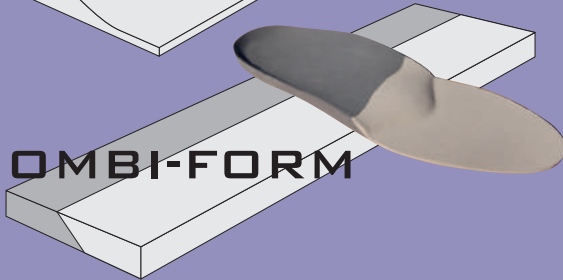

* andere Abmessungen sind möglich
other dimensions are possible
andere afmetingen zijn mogelijk
autres dimensions sont possibles

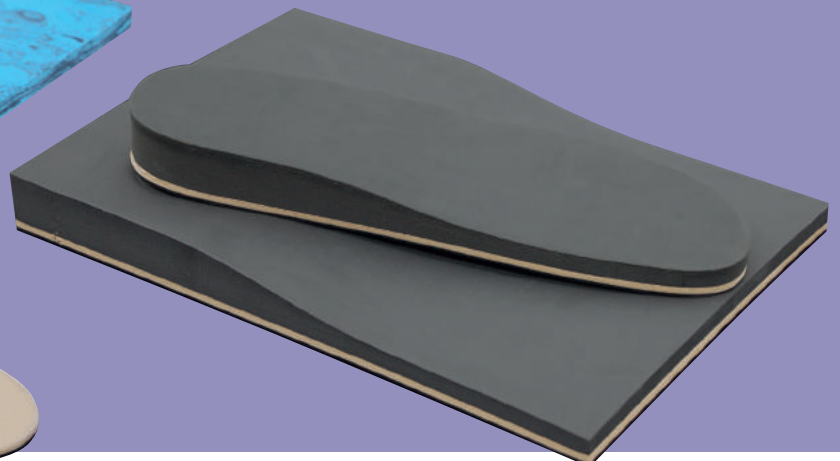
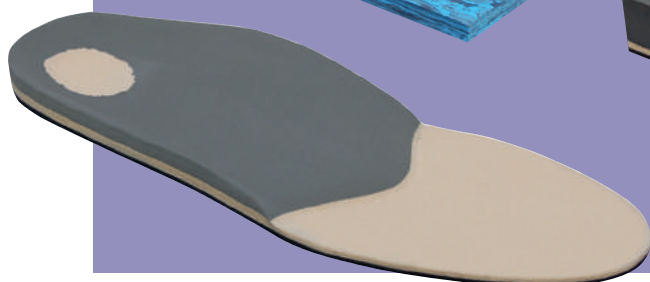
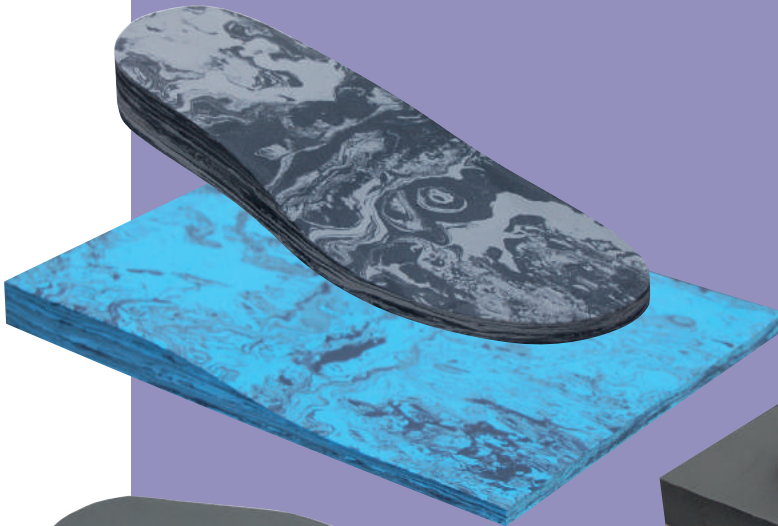



	15mm	20mm	25mm	30mm	35mm	40mm
shore	20>60	20>60	20>60	20> 70	20>60	20>60

EVACAD

	30mm > 5/25	40mm > 10/30	35mm > 8/27
Shore			
30	•	•	
35		•	
40	•	•	
45	•	•	
50	•	•	
60	•		•

EVASTAT

	30mm > 5/25	40mm > 10/30
Shore		
30	•	•
35		•
40		•
45	•	•
50		•
60	•	

Shore70 - 30mm: only UNIFORM

EVA CARBOSTAT

	30mm > 5/25	40mm > 10/30
Shore		
30		•
40	•	•
50		•

EVA MARBLE

	40mm > 10/30
Shore	
40	•
50	•

EVA CORK

	30mm > 5/25	40mm > 10/30
Shore		
45	•	•
55	•	•

IT-AIR CORK HARD 70010.



142 x 92cm



IT-AIR CORK SOFT 70011.



155 x 95cm



IT-AIR CORK

VORTEILE

- EVA/Kork Mischung, sehr leicht, keine Schrumpfung
- Perfekt geeignet zur thermischen Verformung (ca. 100°C)
- Anwendung für Orthesenbau und Einlagen

ADVANTAGES

- EVA/cork mixture, very light, no shrinkage
- Perfect for thermo moulding (ca. 100°C)
- For the construction of orthoses, insoles and orthopaedic foot supports

VOORDELEN

- EVA/kurk mengeling, zeer licht, geen krimp
- Perfect thermisch vervormbaar (ca. 100°C)
- Toepassingen: orthesenbouw en steunzolen

AVANTAGES

- Mélange EVA/liège, très léger, pas de rétrécissement
- Idéal pour thermoformage (ca. 100°C)
- Pour la construction des orthèses et semelles orthopédiques

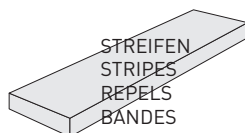

> part 11



> page 1.27

**Wir liefern Ihnen diese Platten auch gestanzt in jeder Größe.
We supply all these materials cut in all different sizes.
Deze platen kunnen gestanzt worden in alle mogelijke modellen.
Nous fournissons ces plaques dans chaque modèle découpé.**

**Alle anderen Stärken sind auf Anfrage lieferbar.
All other thicknesses can be delivered on request.
Alle andere diktes leverbaar op aanvraag.
D'autres épaisseurs livrables sur demande.**

		70010	70011
		It-air hart It-air hard It-air dur	It-air weich It-air soft It-air souple
015	1,5 mm	●	●
02	2 mm	●	●
03	3 mm	●	●
04	4 mm	●	●
05	5 mm	●	●
06	6 mm	●	●
08	8 mm	●	●
10	10 mm	●	●
12	12 mm	●	●
15	15 mm	●	●
16	16 mm	●	●
20	20 mm	●	●
25	25 mm	●	●
30	30 mm	●	●

Farbabweichungen zwischen dem Farbdruck und dem Originalprodukt sind möglich.
Colour differences between print and original product are possible.
Kleurverschillen tussen het drukwerk en het origineel product zijn mogelijk.
Des différences de couleur entre l'imprimerie et la produit originale sont possible.



CORK 149.



STREIFEN - STRIPES - REPELS - BANDES

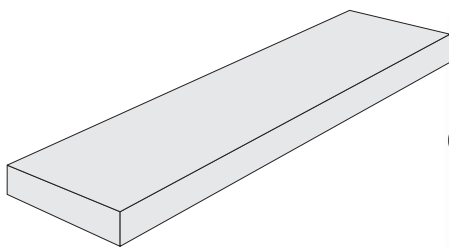

		0	1	3	5
		IT-AIR Hard L: 92 cm	IT-AIR Soft L: 95 cm	Naturkork natural cork natuurkurk liège naturel L: 100 cm	Presskork press cork perskurk liège aglom. L: 100 cm
1050	10 x 50 cm	•	•	•	•
1060	10 x 60 cm	•	•	•	•

MICRO CORK ECO HARD 70012.



95 x 77cm

VORTEILE:

- EVA/Kork Mischung, sehr leicht, keine Schrumpfung
- Perfekt geeignet zur thermischen Verformung (ca. 100°C)
- Anwendung für Orthesenbau und Einlagen
- Sehr preiswert

ADVANTAGES:

- EVA/cork mixture, very light, no shrinkage
- Perfect for thermo moulding (ca. 100°C)
- For the construction of orthoses, insoles and orthopaedic foot supports
- Best value for money

VOORDELEN:

- EVA/kurk mengeling, zeer licht, geen krimp
- Perfect thermisch vervormbaar (ca. 100°C)
- Toepassingen: orthesenbouw en steunzolen
- Zeer prijsgunstig

AVANTAGES

- Mélange EVA/liège, très léger, pas de rétrécissement
- Idéal pour thermoformage (ca. 100°C)
- Pour la construction des orthèses et semelles orthopédiques
- Très avantageux



**Wir liefern Ihnen diese Platten auch gestanzt in jeder Größe.
We supply all these materials cut in all different sizes.
Deze platen kunnen gestanst worden in alle mogelijke modellen.
Nous fournissons ces plaques dans chaque modèle découpé.**

**Alle anderen Stärken sind auf Anfrage lieferbar.
All other thicknesses can be delivered on request.
Alle andere diktes leverbaar op aanvraag.
D'autres épaisseurs livrables sur demande.**

		70012
		Eco hart Eco hard Eco hard Eco dur
015	1,5 mm	•
02	2 mm	•
03	3 mm	•
04	4 mm	•
05	5 mm	•
06	6 mm	•
08	8 mm	•
10	10 mm	•
12	12 mm	•
15	15 mm	•
20	20 mm	•
30	30 mm	•

PRESSKORK P-25 70020.



Nicht thermisch verformbar - flexibel und sehr leicht - sehr preiswert
Not thermo mouldable - flexible and very light material - best value for money
Niet thermisch vervormbaar - flexibel en zeer licht - zeer prijsgunstig
Pas de thermoformage - flexible et très léger - très avantageux

100 x 50cm



NATURKORK 70013.



Nicht thermisch verformbar - flexibel und sehr leicht
Not thermo mouldable - flexible and very light material
Niet thermisch vervormbaar - flexibel en zeer licht
Pas de thermoformage - flexible et très léger

100 x 50cm

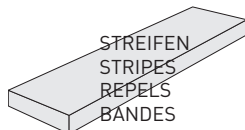

Wir liefern Ihnen diese Platten auch gestanzt in jeder Größe.
We supply all these materials cut in all different sizes.
Deze platen kunnen gestanst worden in alle mogelijke modellen.
Nous fournissons ces plaques dans chaque modèle découpé.

Alle anderen Stärken sind auf Anfrage lieferbar.
All other thicknesses can be delivered on request.
Alle andere diktes leverbaar op aanvraag.
D'autres épaisseurs livrables sur demande.

		70013	70020
		Naturkork natural cork natuurkurk liège naturel	Presskork press cork perskurk liège aglom.
015	1,5 mm	●	●
02	2 mm	●	●
03	3 mm	●	●
04	4 mm	●	●
05	5 mm	●	●
06	6 mm	●	●
08	8 mm	●	●
10	10 mm	●	●
12	12 mm	●	●
15	15 mm	●	●
20	20 mm	●	●
25	25 mm	●	●
30	30 mm	●	●
60	60 mm	●	●

NATURKORK 70022.

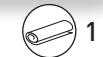

Roll/roll/rol/rouleau 100cm



		70022
		Naturkork auf Rolle natural cork on roll natuurkurk op rol liège naturel en rouleau
30	3 mm x 51 m	●
50	5 mm x 31 m	●



LATEXKORK 70019.



Sehr elastisch und flexibel
 Very elastic and flexible
 Zeer hoog elastisch en soepel
 Très élastique et souple

90 x 60cm



RL105 GUMMIKORK 70015.



100 x 50cm



AB GUMMIKORK 70018.



91 x 45cm



VORTEILE

- Leistenkork, stark mit Latex gebunden, flexibel und abriebfest
- Leicht zu verarbeiten und stabil
- Hohes spezifisches Gewicht
- Nicht thermisch verformbar

ADVANTAGES

- Cork for lasts, combined with latex, flexible and high resistant
- The material is easy to process and stable
- Heavy specific gravity
- Not thermo mouldable

VOORDELEN

- Leestenkurk, zeer sterk latexgebonden, flexibel en slijtvast
- Zeer goed verwerkbaar en stabiel
- Hoog soortelijk gewicht
- Niet thermisch vervormbaar

AVANTAGES

- Liège pour forme, combiné avec latex, flexible et résistant
- Traitement facile, produit extrêmement stable
- Poids spécifique lourd
- Pas de thermoformage



	70019	70015	70018
	Latexkork latex cork moussekurk liège mousse	RL105	AB

015	1,5 mm	•	•	•
02	2 mm	•	•	•
03	3 mm	•	•	•
04	4 mm	•	•	•
05	5 mm	•	•	•
06	6 mm	•	•	•
08	8 mm	•	•	•
10	10 mm	•	•	•
12	12 mm	•		
15	15 mm	•	•	•
20	20 mm	•	•	•

Farbabweichungen zwischen dem Farbdruck und dem Originalprodukt sind möglich.
 Colour differences between print and original product are possible.
 Kleurverschillen tussen het drukwerk en het origineel product zijn mogelijk.
 Des différences de couleur entre l'imprimerie et la produit originale sont possible.

1.07

**VERSTEIFUNGSMATERIAL
STIFFENING MATERIAL
VERSTIJVINGSSTOFFEN
TOILES THERMOCOLLANTES**

☐ = eine Seite klebend
= preglued one side
= enkelzijdig voorgelijmd
= précollé une face

THERMO 70040.



100 x 50cm

Hartes Zwischensohlenmaterial für Einlagen
Hard innersole material for inlays
Hard tussenmateriaal voor steunzolen
Intercalaire dur pour semelles orthopédique

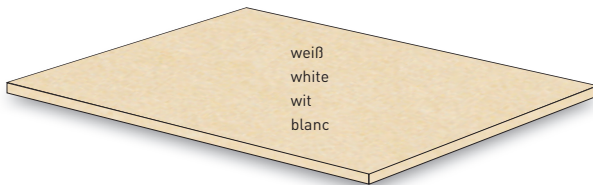

		100 x 135 cm	100 x 140 cm
09	0,9 mm ☐		●
12	1,2 mm ☐	●	
15	1,5 mm ☐		●
17	1,75 mm ☐		●

THERMO PLUS 70043.



100 x 150cm

Extrem hartes Material mit extra inkorporierter Struktur, eine Seite klebend
Extremely hard material with extra-incorporated structure, preglued one side
Extreem hard materiaal met extra geweven structuur, enkelzijdig voorgelijmd
Matériel extrêmement dur avec structure supplémentaire incorporé, précollé une face

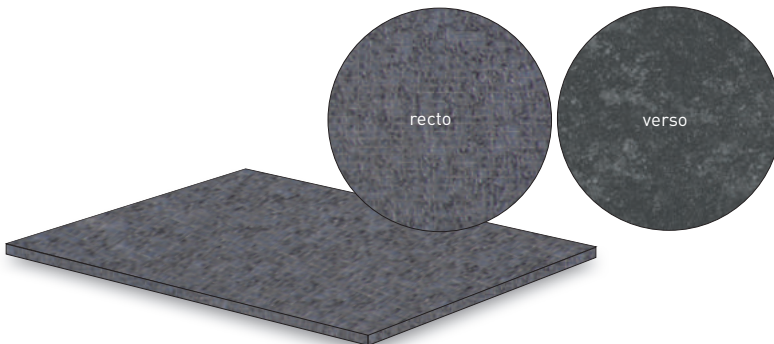

16	1,6 mm ☐	●
20	2,0 mm ☐	●

THERMO ANTRACITE 70044.



100 x 150cm

Sehr hartes Material, hohe Stabilität, eine Seite klebend
Very hard material, high stability, preglued one side
Zeer hard, extra stabiliteit, enkelzijdig voorgelijmd
Matériel très dur, haute stabilité, précollé une face

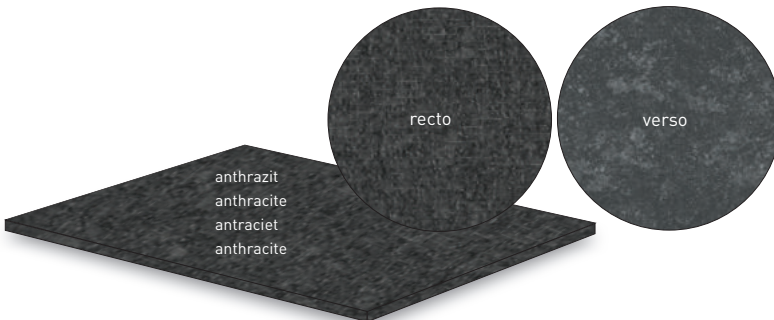

14	1,4 mm ☐	●
21	2,1 mm ☐	●



Wir liefern Ihnen diese Platten auch gestanzt in jeder Größe.
We supply all these materials cut in all different sizes.
Deze platen kunnen gestanst worden in alle mogelijke modellen.
Nous fournissons ces plaques dans chaque modèle découpé.



 = Doppelseitig klebend
 = preglued both sides
 = dubbelzijdig voorgelijmd
 = précollé deux faces

EXTRAFLEX 70046.



Sehr stabiles Versteifungsmaterial, doppelseitig klebend; hervorragend zu schleifen. Speziell für Orthesen, Hinterkappen und Schäfte.

100 x 150cm

Very stable stiffening tissue, preglued both sides; perfectly grindable and glueable. Specifically for orthosis, counters and shafts.

Zeer stabiel verstijvingmateriaal, dubbelzijdig voorgelijmd; zeer goed slijpbaar. Specifiek voor orthesen, contreforts en schachten.

Matériel de renforcement très stable, précollé deux faces; très facile à polir. Spécifiquement pour orthèses, contreforts et tiges.

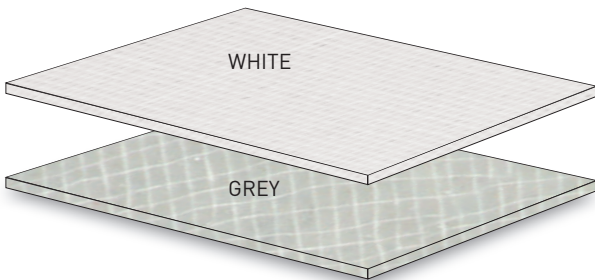

		6	8
		WHITE	GREY
06	0,6 mm 	•	
08	0,8 mm 	•	•
10	1,0 mm 	•	
12	1,2 mm 	•	•
14	1,4 mm 	•	•
16	1,6 mm 	•	
18	1,8 mm 	•	•

MULTIFLEX BLUE 700488.



 Extraflex

100 x 150cm

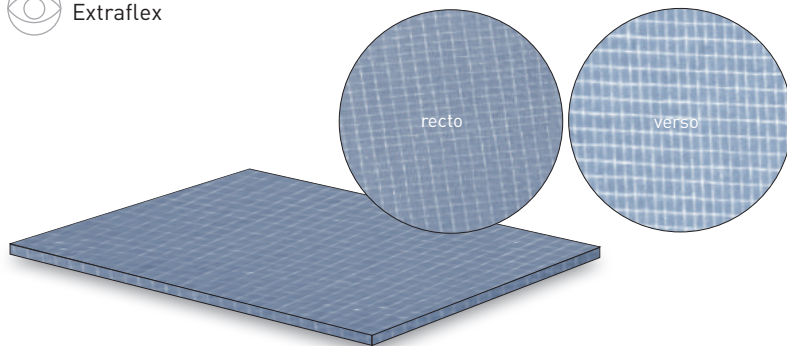

09	0,9 mm 	•
13	1,3 mm 	•

MAX GROEN 70049.



 Extraflex

100 x 150cm

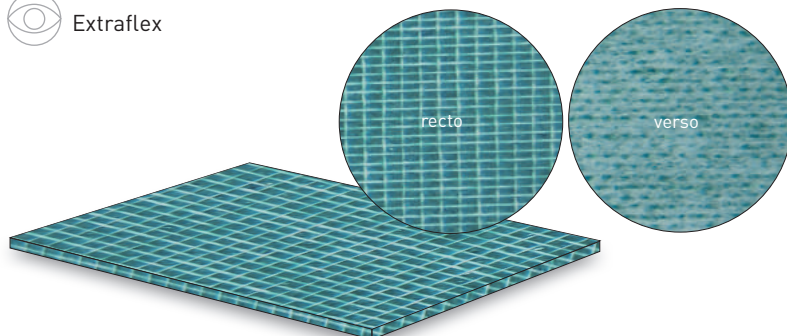

11	1,1 mm 	•
15	1,5 mm 	•

Farbabweichungen zwischen dem Farbdruck und dem Originalprodukt sind möglich.
 Colour differences between print and original product are possible.
 Kleurverschillen tussen het drukwerk en het origineel product zijn mogelijk.
 Des différences de couleur entre l'imprimerie et la produit originale sont possible.

☐ = eine Seite klebend
= preglued one side
= enkelzijdig voorgelijmd
= précollé une face

COVER BLACK OR BLUE 70041.



Sehr dünnes und flexibles Versteifungsmaterial für Vorderkappen von Schuhen.
Very thin and flexible stiffening material for toe caps.
Zeer dun flexibel verstijvingmateriaal voor neuzen van schoenen.
Matière de renforcement très fin, flexible pour bouts de chaussures.

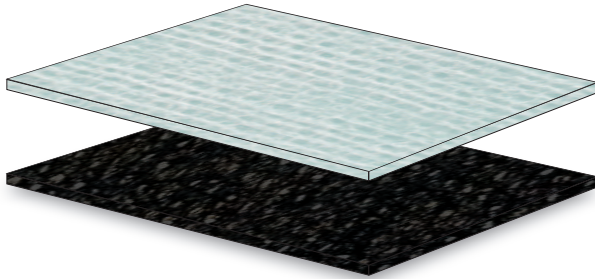

		0	8
		BLACK	BLUE
		100 x 150cm	100 x 150cm
70	0,70 mm	●	
75	0,75 mm		●
85	0,85 mm		●
95	0,95 mm		●

COVER PLUS 70042.



Sehr dünnes und flexibles Versteifungsmaterial für Vorderkappen von Schuhen.
Very thin and flexible stiffening material for toe caps.
Zeer dun flexibel verstijvingmateriaal voor neuzen van schoenen.
Matière de renforcement très fin, flexible pour bouts de chaussures.

100 x 150cm

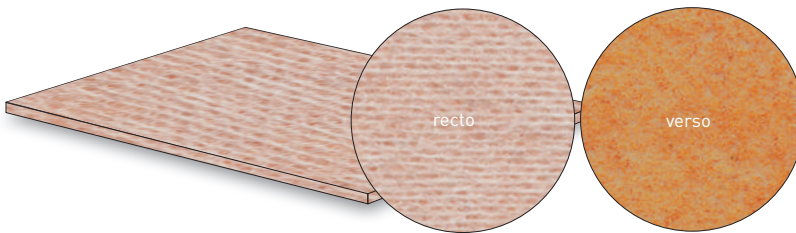

10	1 mm	●
17	1,7 mm	●

DUROFLEX (COMBI) 70045.



Relativ flexibel, gute Stabilität, eine Seite klebend
Relatively flexible, good stability, preglued one side
Relatief flexibel, goede stabiliteit, enkelzijdig voorgelijmd
Relativement flexible, bonne stabilité, précollé une face

100 x 150cm

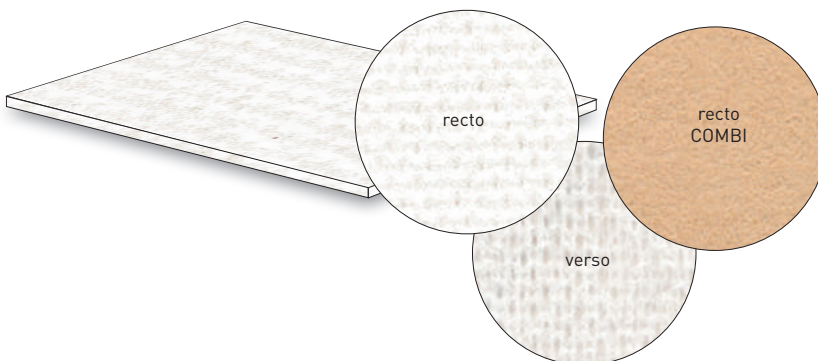

12	1,2 mm	●	1,50 m ²
19	1,9 mm	●	1,50 m ²

COMBI:

Mit einer Extraschicht Viledon
With extra viledon layer
Met extra viledon laag
Avec couche viledon supplémentaire

SK25 SYNTAX 70047025



Synthetisches Innenschuhmaterial, nicht klebend
Synthetic insole material, without glue
Synthetisch binnenzool materiaal, niet voorgelijmd
Première synthétique, sans colle

2,5mm - 142 x 100cm

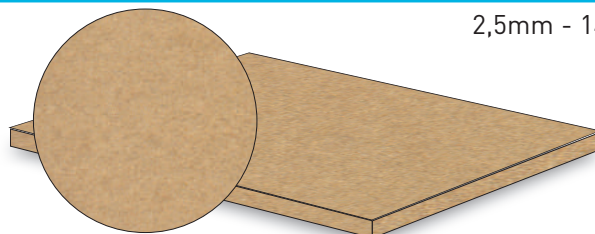



TEXON 70047325

**NEU
NEW
NIEUW
NOUVEAU**



3mm - 1,5m²

Texon 437 ist ein sehr hochwertiges Zellulose-Material für die Innensohle des Schuhs. Es wird benutzt als Versteifungsstoff zwischen der Außen- und der Einlegesohle.

Texon 437 is a high quality cellulose insole material for shoes. It is used as a reinforcing layer between the outer sole and the insole.

Texon 437 is een zeer hoogwaardig cellulose binnenzool materiaal voor schoenen. Het wordt gebruikt als verstevigende laag tussen de buitenzool en de inlegzool.

Texon 437 est un matériau premier de cellulose de haute qualité pour les chaussures. Il est utilisé comme une couche raffermissante entre la semelle extérieure et la semelle intérieure.

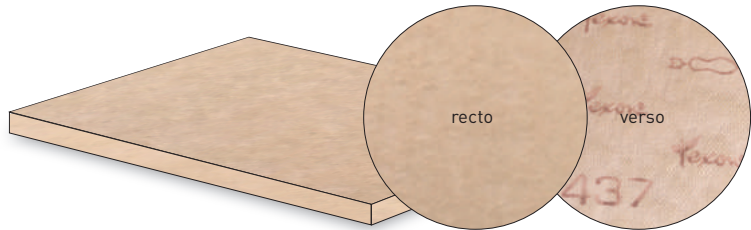

KAPPEN 7004NCO.



25p

**COVER BLUE
KAPPEN
TOEPUFF
NEUS
REINFORCEMENT**

small	0,70 mm	7004NCO.1207
medium	0,70 mm	7004NCO.2307
large	0,95 mm	7004NCO.3109

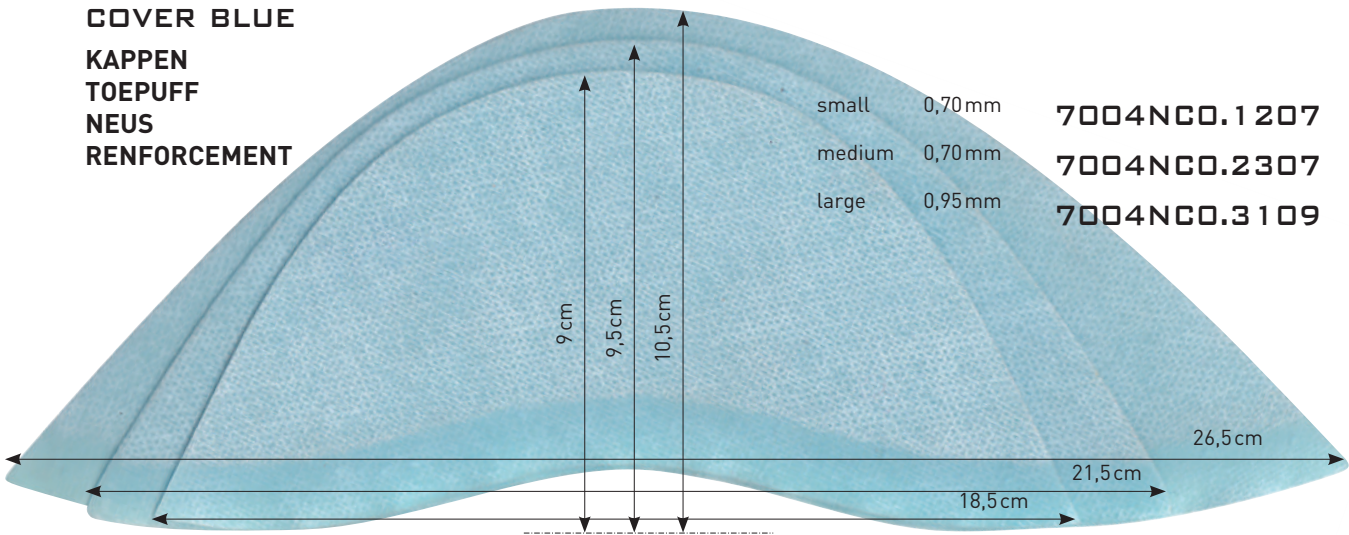

CONTREFORT 7004CF.



25p

**FLEX WHITE
FERSENKAPPEN
COUNTER WHITE
CONTREFORT
REINFORCEMENT**

small	1,8 mm	7004CF.001
medium	1,8 mm	7004CF.002

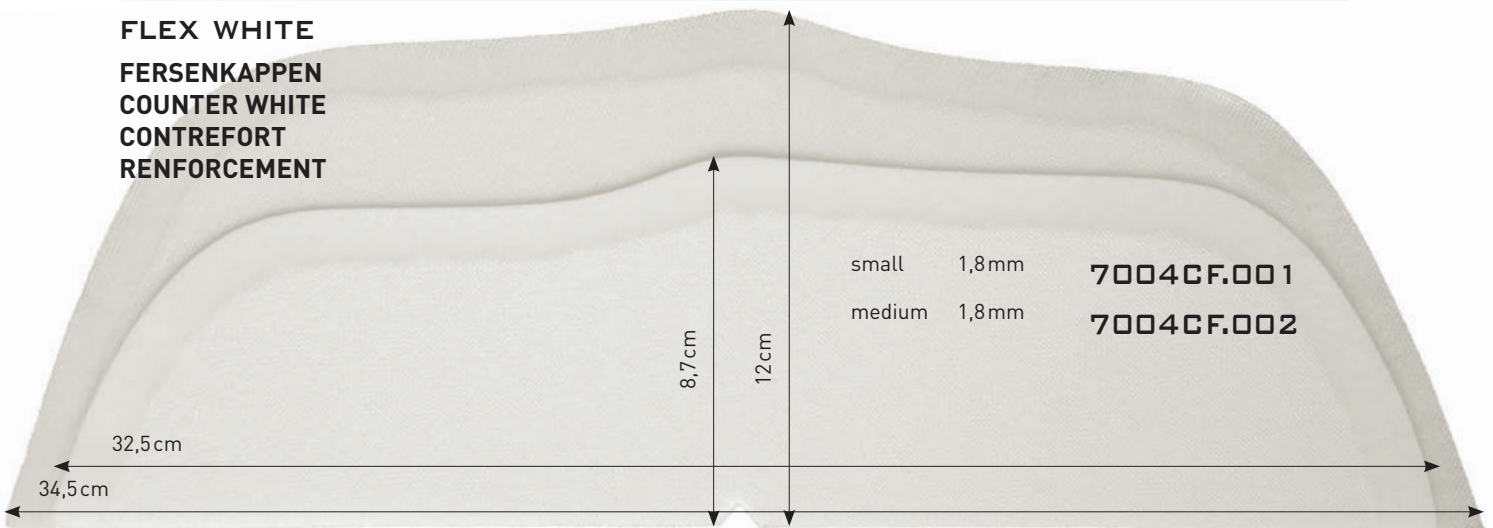

Farbabweichungen zwischen dem Farbdruck und dem Originalprodukt sind möglich.
Colour differences between print and original product are possible.
Kleurverschillen tussen het drukwerk en het origineel product zijn mogelijk.
Des différences de couleur entre l'imprimerie et la produit originale sont possible.

Exclusive supplier of the only original PPT for Europe



das einzige original PPT®

- PU Schaumstoff, offen Zellular
- Niedrige Densität
- Medisch geprüft
- Extrem hohe Rückstellkraft, nicht thermisch verformbar
- PPT® normal in blau oder hautfarbe, Slow Recovery in orange
- In 1,6 und 3,2mm; Normal PPT® auch in 4,5 - 6,4 - 9,5mm.
- 13 - 21, Shore A

USAGE

- extrem gute hohe Stossdämpfung; extrem hohe Rückstellkraft.
- Einfach zu verarbeiten, nicht thermisch verformbar
- Leicht gewicht
- Abwaschbar
- Verbesserte Reissfestigkeit und Leistungsfähig
- Schützt der Patient im Bereich von Prothesen, Orthesen und jede andere orthopaedische Anwendung
- Porös: behaltet die Haut trocken, frisch und gibt Bequemlichkeit

de enige originele PPT®

- Polyurethaan open cellulaire structuur
- Lage densiteit
- Medisch getest
- Goed materiaalgeheugen voorkomt thermoforming
- In blauw of huidskleur; Slow Recovery in oranje
- In 1,6 en 3,2mm; gewone PPT® ook in 4,5 - 6,4 - 9,5mm
- 13 - 21, Shore A

GEBRUIK

- Uitzonderlijke schokdempende eigenschappen; komt altijd naar zijn oorspronkelijke vorm terug.
- Eenvoudig te verwerken. niet thermisch vervormbaar
- Lichtgewicht
- Afwasbaar
- Verbeterde draag- en scheurbestendigheid
- Beschermt de patient bij dragen van prothese of orthese etc.
- Poreus: houdt de huid droog, fris en geeft comfort

the only original PPT®

- Open cell frothed polyurethane
- Low density
- Medical grade
- Good memory prevents thermoforming
- In blue or skin colour; Slow Recovery in orange
- In 1,6 and 3,2mm; regular PPT® also in 4,5 - 6,4 - 9,5mm
- 13 - 21, Shore A

USE

- Exceptional shock attenuating properties; always returns to its original form.
- Easy to manipulate, not thermo mouldable
- Lightweight
- Washable
- Improved wear and tear characteristics
- Patient protection in orthoses, prostheses, orthopaedic appliances
- Porous to help skin remain dry, cool and comfortable

le seul PPT® original

- Polyurethane structure cellulaire ouverte
- Densité basse
- Testé médicale
- Bonne mémoire, prévient thermoformage
- En bleu ou couleur chair. 'Mémoire lente' en orange
- PPT® normal en 1,6mm - 3,2mm - 4,5mm - 6,4mm - 9,5mm
- 13 - 21, Shore A

USAGE

- Caractéristiques anti-choc exceptionnelles; revient toujours à sa forme initiale
- Facilement à manipuler; pas thermoformable
- Poids léger
- Lavable
- Qualité déchirure et portée amélioré
- Protection pour le patient en orthèse, prothèse ainsi que chaque application orthopédique
- Poreux: aide la peau à rester sec, frais et confortable

Professional Protective Technology



ROLLEN ROLLS ROLLEN ROULEAUX



 **SM/AB**
glatt/rauh
smooth/abraided
glad/ruw
lisse/rugueux





 **AB/AB**
beidseitig gerauh
abraided/abraided
beide zijden ruw
les deux côtés rugueux

 **AB/ME (=PLUS)**
rauh/PE-Schicht
abraided/PE-mesh
ruw/PE-gaas
rugueux/tissue en PE

PPT 70055.0.

PPT 70059.0.

ULTRALUX



		□ not perforated			
		1 	2 	3 	4 
		hautfarbe tan huidskleur couleur chair	hautfarbe tan huidskleur couleur chair	blau blue blauw bleu	blau blue blauw bleu
30,5 x 1,5m = 46m ²	16 1,6 mm	R622	R624	R602	R604
30,5 x 1,5m = 46m ²	25 2,5 mm	R922	R924	R902	R904
30,5 x 1,5m = 46m ²	32 3,2 mm	R822	R824	R802	R804
24,38 x 1,5m = 36,57m ²	45 4,5 mm	R522	R524	R502	
18,3 x 1,5m = 27,45m ²	64 6,4 mm	R422		R402	
12,19 x 1,5m = 18,285 m ²	95 9,5 mm	R322		R302	

□ not perforated	
1	2
schwarz/hautfarbe black/tan zwart/huidskleur noir/couleur chair	blau blue blauw bleu
R629	R609
R929	R909
	R809

PPT+ 70056.0.



PLUS

Better wear resistance due to incorporated unwoven PE-mesh
Bessere Verschleißfestigkeit durch den integrierten PE-Schicht
Hogere slijtvastheid door het ingewerkte PE-gaas
Meillieure resistance grâce à la couche tissue en PE incorporée

		□ not perforated	
		1 	5 
		hautfarbe tan huidskleur couleur chair	blau blue blauw bleu
30,5 x 1,5m = 46m ²	16 1,6 mm	R623	R603
	32 3,2 mm	R823	R803

PPT SR 70057.0.

SLOW RECOVERY

		□ not perforated		
		0 	3 	700580016 
		orange orange oranje orange	orange orange oranje orange	orange orange oranje orange SLOW RECOVERY PLUS
30,5 x 1,5m = 46m ²	16 1,6 mm	R642	R644	R643
	32 3,2 mm	R842	R844	

MINIROLLEN
MINI ROLLS
MINI ROLLEN
ROULEAUX MINI



SM/AB
glatt/rauh
smooth/abraded
glad/ruw
lisse/rugueux



AB/AB
beidseitig gerauht
abraded/abraded
beide zijden ruw
les deux côtés rugueux



AB/ME (=PLUS)
rauh/PE-Schicht
abraded/PE-mesh
ruw/PE-gaas
rugueux/tissue en PE

PPT 7006.01.

nicht perforiert
not perforated
niet geperforeerd
non perforé

hautfarbe
tan
huidskleur
couleur chair



			1	2
			 SM/AB glatt/rauh smooth/abraded glad/ruw lisse/rugueux	 AB/AB beidseitig gerauht abraded/abraded beide zijden ruw les deux côtés rugueux
11,5 x 15m	16	1,6 mm	•	•
11,5 x 15m	32	3,2 mm	•	•
11,5 x 12m	45	4,5 mm	•	•
11,5 x 9m	64	6,4 mm	•	



> page 1.50



60300002 AFT

Display für Bezugsstoffe auf Mini-Rollen
Display for fabrics on mini rolls
Display voor bekledings-stoffen op mini-rollen
Présentoir pour tissus sur mini rouleaux

PPT 70064.0.0. ULTRALUX

□
not perforated



	1	2
schwarz/hautfarbe black/tan zwart/huidskleur noir/couleur chair	blau blue blauw bleu	

152 x 65cm

16	1,6 mm	M629	M609
25	2,5 mm	M929	M909
32	3,2 mm		M809

PPT® Zwischenschicht
PPT® intermediate layer
PPT® Tussenzool
PPT® intercalaire

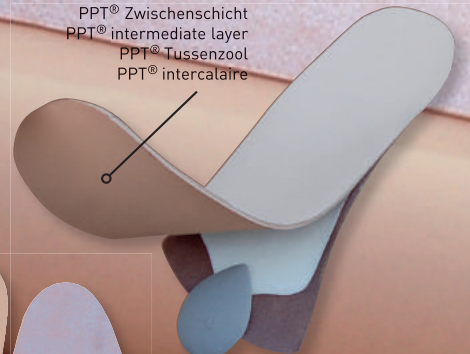

Exclusive supplier of
the only original PPT
for Europe



PLATTEN
SHEETS
PLATEN
PLAQUES



1 152 x 65cm

PPT 70051.

PPT 70054.0.

ULTRALUX

		□ not perforated				5 PERFO		□ not perforated	
		1	2	3	4	1	3	1	2
152 x 65cm		hautfarbe tan huidskleur couleur chair	hautfarbe tan huidskleur couleur chair	blau blue blauw bleu	blau blue blauw bleu	hautfarbe tan huidskleur couleur chair	blau blue blauw bleu	schwarz/hautfarbe black/tan zwart/huidskleur noir/couleur chair	blau blue blauw bleu
16	1,6 mm	P622	P624	P602	P604	P622-P	P602-P	P629	P609
25	2,5 mm	P922	P924	P902	P904			P929	P909
32	3,2 mm	P822	P824	P802	P804	P822-P	P802-P		P809
45	4,5 mm	P522	P524	P502		P522-P	P502-P		
64	6,4 mm	P422		P402					
95	9,5 mm	P322		P302					

PPT+ 70052.0.

PLUS

Bessere Verschleißfestigkeit durch den integrierten PE-Schicht
Better wear resistance due to incorporated unwoven PE-mesh
Hogere slijtvastheid door het ingewerkte PE-gaas
Meilleure resistance grâce à la couche tissu en PE incorporée

		□ not perforated	
		1	2
152 x 65cm		hautfarbe tan huidskleur couleur chair	blau blue blauw bleu
16	1,6 mm	P623	P603
32	3,2 mm	P823	P803

PPT SR 70053.0.





SLOW RECOVERY

		□ not perforated		
		1	2	3
152 x 65cm		orange orange orange orange	orange orange orange orange	orange orange orange orange
16	1,6 mm	P642	P644	P643
32	3,2 mm	P842	P844	

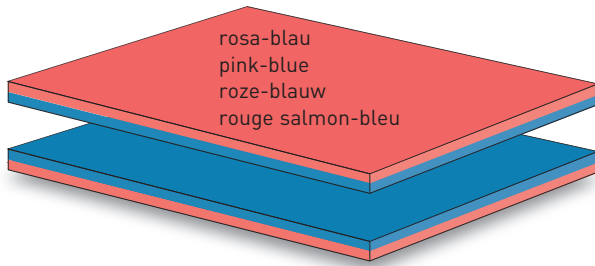
Wir liefern Ihnen diese Platten auch gestanzt in jeder Größe.
Custom size may be ordered to best meet special needs.
Deze platen kunnen op gewenste maat geleverd worden.
Nous fournissons ces plaques en mesures souhaitées.





PU DUO LAYER 7023.   .530

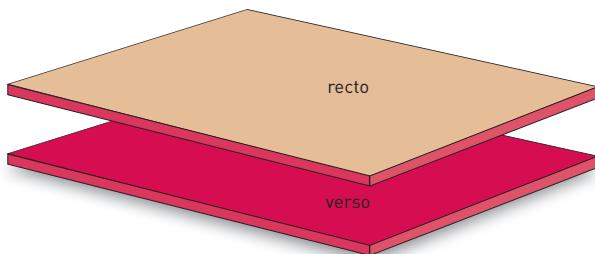

	1 	5 
	Platten sheets platen plaques	Rollen rolls rollen rouleaux
	0	
	nicht perforiert/not perforated/ niet geperforeerd/non perforé	
	30 3,0 mm	137 x 73 cm = 1m ² ±69 m ²



PU SLOW MICRO 7024.   .935

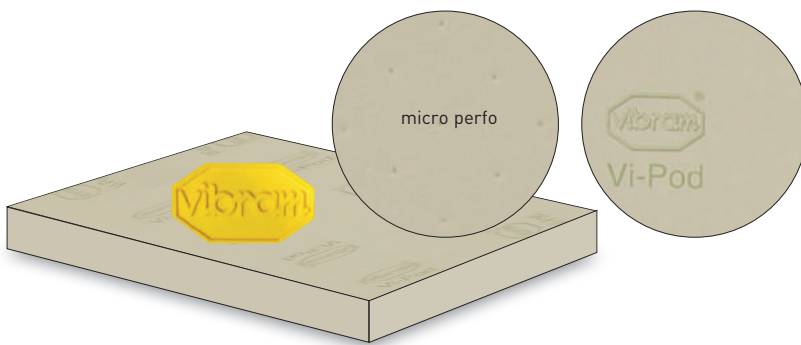

	1 	5 
	Platten sheets platen plaques	Rollen rolls rollen rouleaux
	0	
	nicht perforiert/not perforated/ niet geperforeerd/non perforé	
	35 3,5 mm	137 x 73 cm = 1m ² ±45 m ²

VI-POD 1528710. 



		1 
		80 x 50cm
		micro perfo
20	2,0 mm	•
40	4,0 mm	•
60	6,0 mm	•

Farbabweichungen zwischen dem Farbdruck und dem Originalprodukt sind möglich.
Colour differences between print and original product are possible.
Kleurverschillen tussen het drukwerk en het origineel product zijn mogelijk.
Des différences de couleur entre l'imprimerie et la produit originale sont possible.



PU DIABET 7021. .9. 1

rosa/salmonpink/zalmroze/rouge saumon

Die neue Generation langsam wiederherstellender PU Schäume speziell für Diabetiker und Rheumapatienten hat eine viel langsamere Rückstellfähigkeit als PPT. Das Material kommt immer in die Originalform zurück und ist extrem flexibel. Es formt sich perfekt um den Fuß und vermindert Druckstellen.

The new generation of PU foams, for diabetics and people who suffer from rheumatism, have a much slower recovery effect as PPT. Therefore it moulds perfectly the contours of your feet. Walking has never been such a joy. It doesn't fight back and takes away all the pressure points.

De nieuwe generatie PU schuimstoffen speciaal voor diabetici en reumapatiënten hebben een veel langzamer hersteleffect dan PPT. Daardoor vormt het zich perfect rond de voet. Het materiaal verzet zich niet en neemt alle drukpunten weg.

Les nouvelles mousses PU, spécialement pour diabétiques et rhumatisants, ont un effet de récupération beaucoup plus lente que PPT. A cause de ça le matériel se forme parfaitement autour du pied. Il ne résiste pas et enlève tous les points de pression.

PU DIABET SLOW 7022. .9. 1

rot/red/rood/rouge





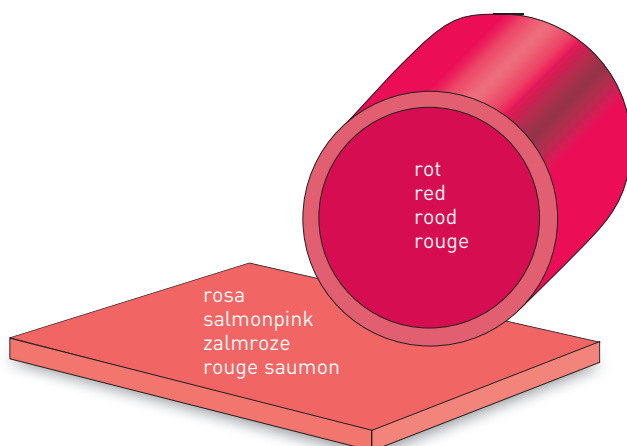

Die gleichen Eigenschaften wie PU DIABET, hat aber eine noch langsamere Rückstellkraft.

The same properties as PU DIABET, but the recovery is even slower.

Dezelfde eigenschappen als PU DIABET, maar met een nog trager hersteleffect.





Les mêmes caractéristiques que PU DIABET, mais l'effet de récupération est encore plus lent.

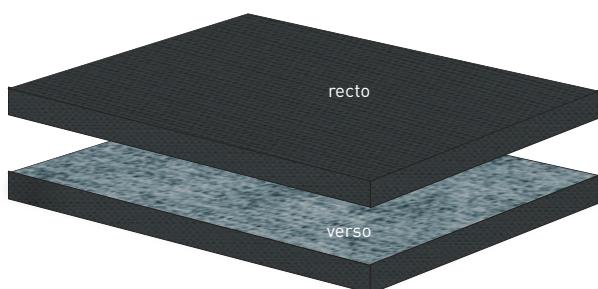

			
	1	5	1
	Platten sheets platen plaques		Rollen rolls rollen rouleaux
			
	nicht perforiert not perforated niet geperforeerd non perforé	nicht perforiert not perforated niet geperforeerd non perforé	
	30	3,0 mm	137 x 73 cm = 1m ²
			±59 m ²
	45	4,5 mm	137 x 73 cm = 1m ²
			±43 m ²
	60	6,0 mm	137 x 73 cm = 1m ²
			±35 m ²

NOENE 70030. 1



			
			schwarz/black/zwart/noir
	20	2 mm	•
	40	4 mm	•

TRILAM 7030700.



90 x 100cm

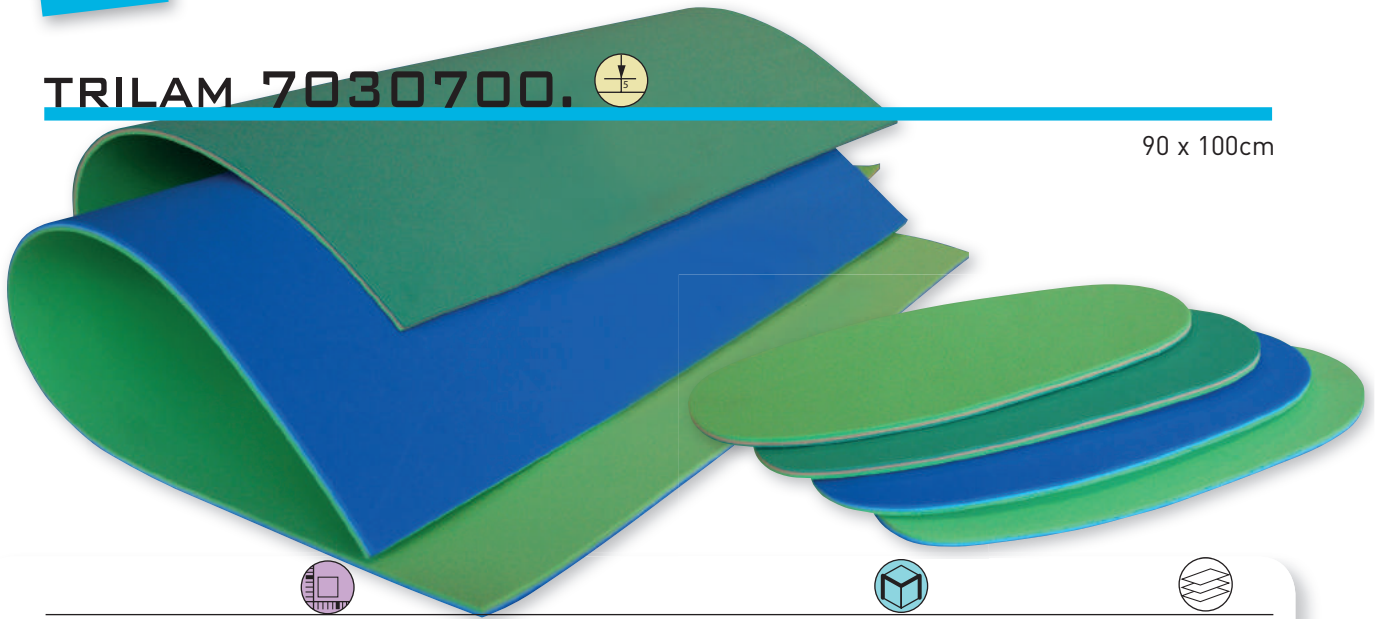

70307001	90 x 100cm	Shore30 - 2mm Shore15 - 2mm Shore35 - 3mm		1
70307002	90 x 100cm	Shore25 - 2mm Shore15 - 2mm Shore35 - 3mm		1

examples - Beispiele - voorbeelden - exemples

Wir verkleben verschiedene Plattenmaterialien für Sie
We can glue different sheet materials together for you
Wij verlijmen voor u verschillende plaatmaterialen tesamen
Possibilité d'assembler plusieurs matériaux

709PB101	50 x 65cm	PPT 1,6mm Extrafoam soft 3mm		3
709PB102	73 x 65cm	PPT 1,6mm PU Diabet slow 3mm		2
709PU201	67 x 73cm	PU Diabet 3mm PU Diabet slow 3mm		2
709TL201	50 x 75cm	Termolast-20 2mm Plastazote 3mm		4
709PH103	75 x 65cm	PPT 1,6mm Plastazote 3mm		4
709PU302	68 x 73cm	Suetex 0,5mm PU Diabet 3mm		2
709PH102	50 x 65cm	Suetex 0,5mm PPT 1,6mm		3



> part 11

Wir liefern Ihnen diese Platten auch gestanzt in jeder Größe.
We supply all these materials cut in all different sizes.
Deze platen kunnen gestanst worden in alle mogelijke modellen.
Nous fournissons ces plaques dans chaque modèle découpé.



ORTHO VARIO FLEX 7005VF.

NEU
NEW
NIEUW
NOUVEAU

Eine neue Kombination von 2 sehr hochwertigen Produkten!

PPT, das beste stoßdämpfende Material auf dem orthopädischen Markt. Laminiert mit echtem Leder ergibt dieses ein sehr hochwertiges Produkt, welches für verschiedene Zwecke eingesetzt werden kann.

A new combination of 2 very high quality products!

PPT, the best shock absorbing material in the orthopaedic market laminated with genuine original leather, results in a very high quality product that can be used directly in several applications.

Een nieuwe combinatie van 2 zeer hoogwaardige producten!

PPT, het beste schokabsorberende materiaal in de orthopedische markt, gelamineerd met echt origineel leder resulteert in een zeer hoogkwalitatief product dat direct gebruikt kan worden in verscheidene toepassingen.

Une nouvelle combinaison entre deux produits de très haute qualité!

PPT, le meilleur matériau d'absorption des chocs sur le marché orthopédique stratifiés avec le cuir original, résultent en un produit de très haute qualité qui peut être directement utilisé dans des applications différentes.

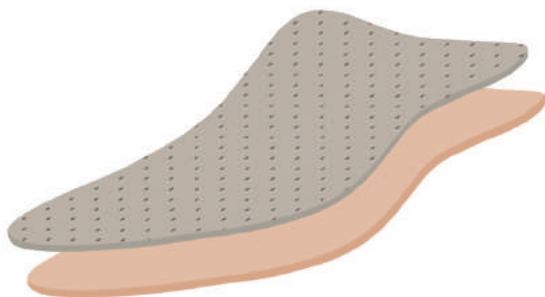

PPT Hautfarbe 1.6mm + Rindsleder gefüttert perfo cream
PPT skin 1.6mm + Calflining perfo cream
PPT huid 1.6mm + Kalfsvoering perfo Cream
PPT chair 1,6mm + doublure de veau perforé Crème

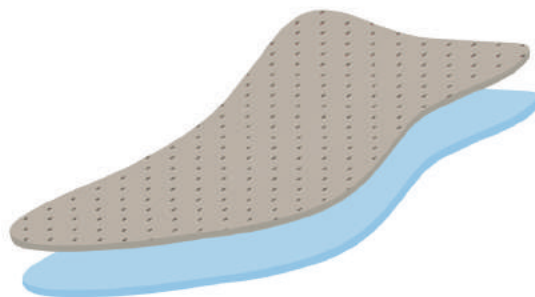

PPT Blau 1.6mm + Rindsleder gefüttert Perfo Cream
PPT blue 1.6mm + Calflining Perfo Cream
PPT blauw 1.6mm + Kalfsvoering perfo Cream
PPT bleu 1,6 mm + doublure de veau perforé crème

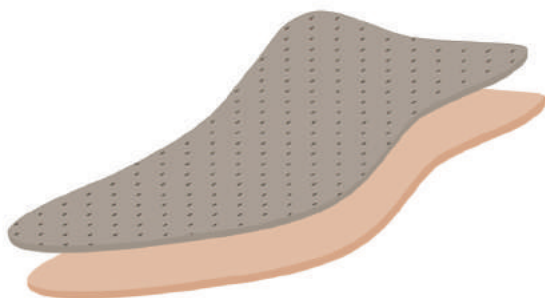

PPT Hautfarbe 1.6mm + Rindsleder gefüttert perfo Dunkel Beige
PPT skin 1.6mm + Calflining Perfo Dark Beige
PPT huid 1.6mm + Kalfsvoering perfo donker beige
PPT chair 1,6mm + doublure de veau perforé beige foncé



PPT Blau 1.6mm + Rindsleder gefüttert Perfo Schwarz
PPT blue 1.6mm + Calflining Perfo Black
PPT blauw 1.6mm + Kalfsvoering perfo zwart
PPT bleu 1,6 mm + doublure de veau perforé noir

Pakete von / packs of / pakketten van / paquets de

4.8 m²

- 20 x small: 300x200mm
- 10 x medium: 400x300mm
- 10 x large: 600x400mm

Andere Stärken und Farben, oder gestanzt auf Anfrage.
Other colours and thicknesses or cut to your size upon request.
Andere kleuren en diktes of gestanst op maat op aanvraag.
Autres couleurs et épaisseurs ou découpé sur mesure, sur demande.

Sparen Sie sich die Zeit und den unnötigen Abfall mit den neuen Ortho Vario-Flex!

Save time and residual waste with our new Ortho Vario-Flex!

Bespaar tijd en restafval met onze nieuwe Ortho Vario-Flex!

Gagnez du temps et des résidus avec notre nouveau Ortho Varia-Flex!

1.10

**BRANDSOHLENMATERIAL
MATERIAL FOR BASE SOLES
MATERIAAL VOOR GRONDPATRONEN
MATÉRIAUX POUR PREMIÈRES**

DURALUX 72501.



38 x 120cm

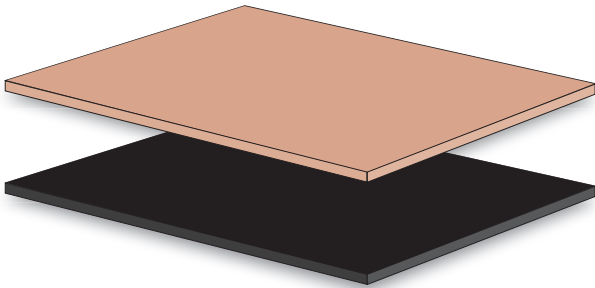

		5	
		0	5
		skin	black
12	1,2 mm	●	●
15	1,5 mm	●	●

COMBI-FORM
Bloc - 30mm
+ Duralux - 1,2mm

ORTHO-FORM
10/30 EVA CORK/45
+ Duralux 1,2mm

> part 11
> part 3.02

Frästechnik
milling techniques
freestechniek
techniques à fraiser

**Auch Hardair in 1,5 und 2 mm sind perfekte Brandsohlenmaterialien.
Also Hardair in 1,5 and 2 mm are perfect materials for base soles.
Ook Hardair in 1,5 en 2 mm zijn perfect geschikt als basismateriaal voor grondpatronen.
Aussi Hardair en 1,5 et 2 mm sont des matériaux parfait pour premières.**

DURALITE 725020.



62 x 73cm

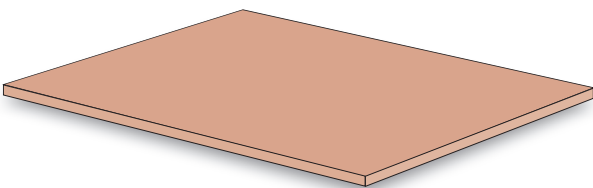

		5	
		0	5
		skin	
12	1,2 mm	●	

REALUX 725001.



40 x 103cm

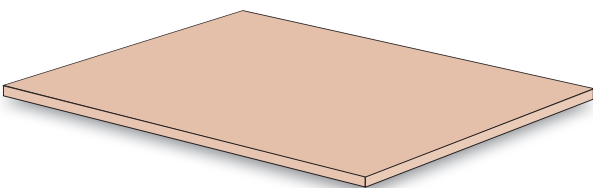

		5	
		0	5
		skin	
011	1,1 mm	●	

Farbabweichungen zwischen dem Farbdruck und dem Originalprodukt sind möglich.
Colour differences between print and original product are possible.
Kleurverschillen tussen het drukwerk en het origineel product zijn mogelijk.
Des différences de couleur entre l'imprimerie et la produit originale sont possible.

VACUPRESS FOLIE 72085.



Transparente Tiefziehfolie für Vacupress
 Transparent thermoplastic sheets for Vacupress
 Transparante folie voor Vacupress
 Plaques thermoformable transparentes pour Vacupress

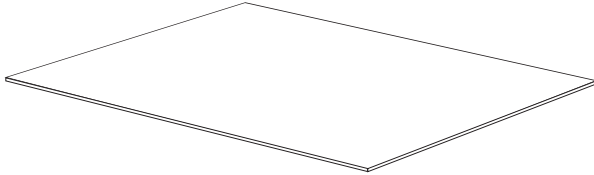

		0,5 mm
		transparent
45	450 x 400 mm	•
60	600 x 450 mm	•

POLYPROP TRANSPA 72082001



120 x 80cm

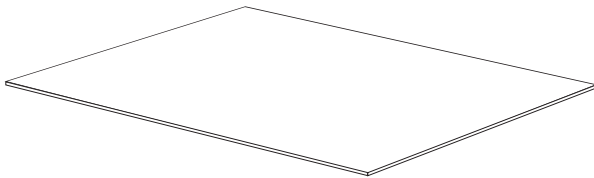

		transparent
01	0,8 mm	•

THERMO EVAFOAM 701808.



4mm

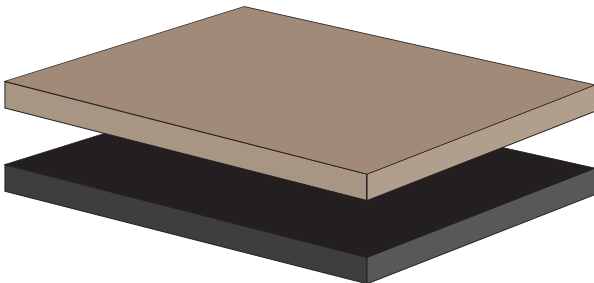

		black	tierra
450 x 400 mm / 4mm	1404		
600 x 450 mm / 4mm	1604	7604	



STREIFYLEN 7040.



Polyethylen, Verformungstemperatur bei 160-170°C, schweißbar, tiefziehfähig, geeignet für Prothesenbau
Polyethylene, high density, thermo mouldable at 160-170°C, suitable for construction of prosthesis
Polyethyleen, hoge densiteit, thermisch vervormbaar bij 160-170°C, geschikt voor prothesenbouw
Polyéthylène, haute densité, thermoformage à 160-170°C, pour la construction de prothèses

200 x 100cm

STREIFYLAST 7043.



Weich-Polyethylen, Verformungstemperatur bei 130-140°C, tiefziehfähig, geeignet für Prothesenbau
Polyethylene, low density, thermo mouldable at 130-140°C, suitable for construction of prosthesis
Polyethyleen, lage densiteit, thermisch vervormbaar bij 130-140°C, geschikt voor prothesenbouw
Polyéthylène, basse densité, thermoformage à 130-140°C, pour la construction de prothèses

200 x 100cm

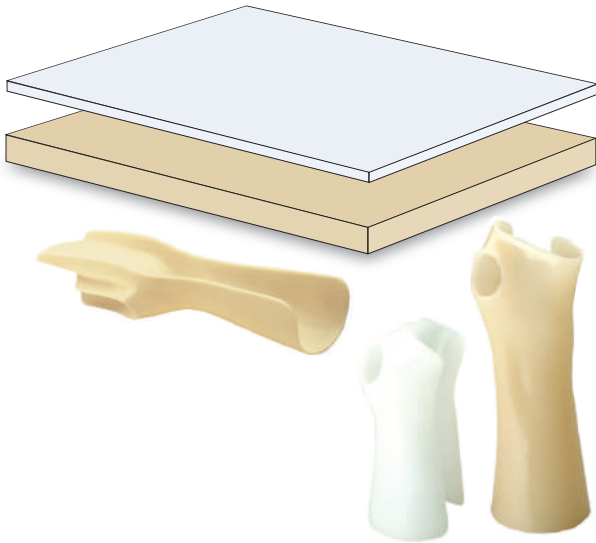

		STREIFYLEN		STREIFYLAST	
		1	6	1	6
		skin	white	skin	white
010	1,0 mm	•	•		•
020	2,0 mm		•		•
030	3,0 mm	•	•	•	•
040	4,0 mm	•	•		•
045	4,5 mm			•	
050	5,0 mm	•	•		•
060	6,0 mm		•		

EXTRALENE 7048.



HDPE, Verformungstemperatur bei 180°C, tiefziehfähig, besonders hohe Festigkeit
HDPE, thermo mouldable at 180°C, extreme high stability
HDPE, thermisch vervormbaar bij 180°C, extreem hoge stabiliteit
HDPE, température de thermoformage 180°C, extrêmement dur

100 x 100cm

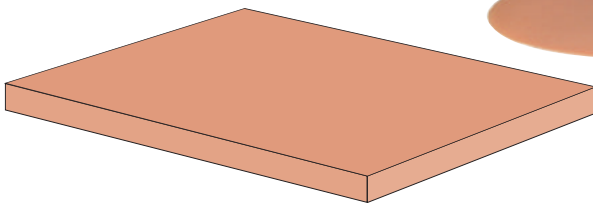

		1
		skin
20	2 mm	•
30	3 mm	•
40	4 mm	•
50	5 mm	•
60	6 mm	•

ERKOFLEX 7202.



		0	1	5
		transp.		
15	1,5 mm	1m ²	±20 m ²	
30	3,0 mm	1m ²	±20 m ²	

		1
		black
40	4,0 mm	1m ²

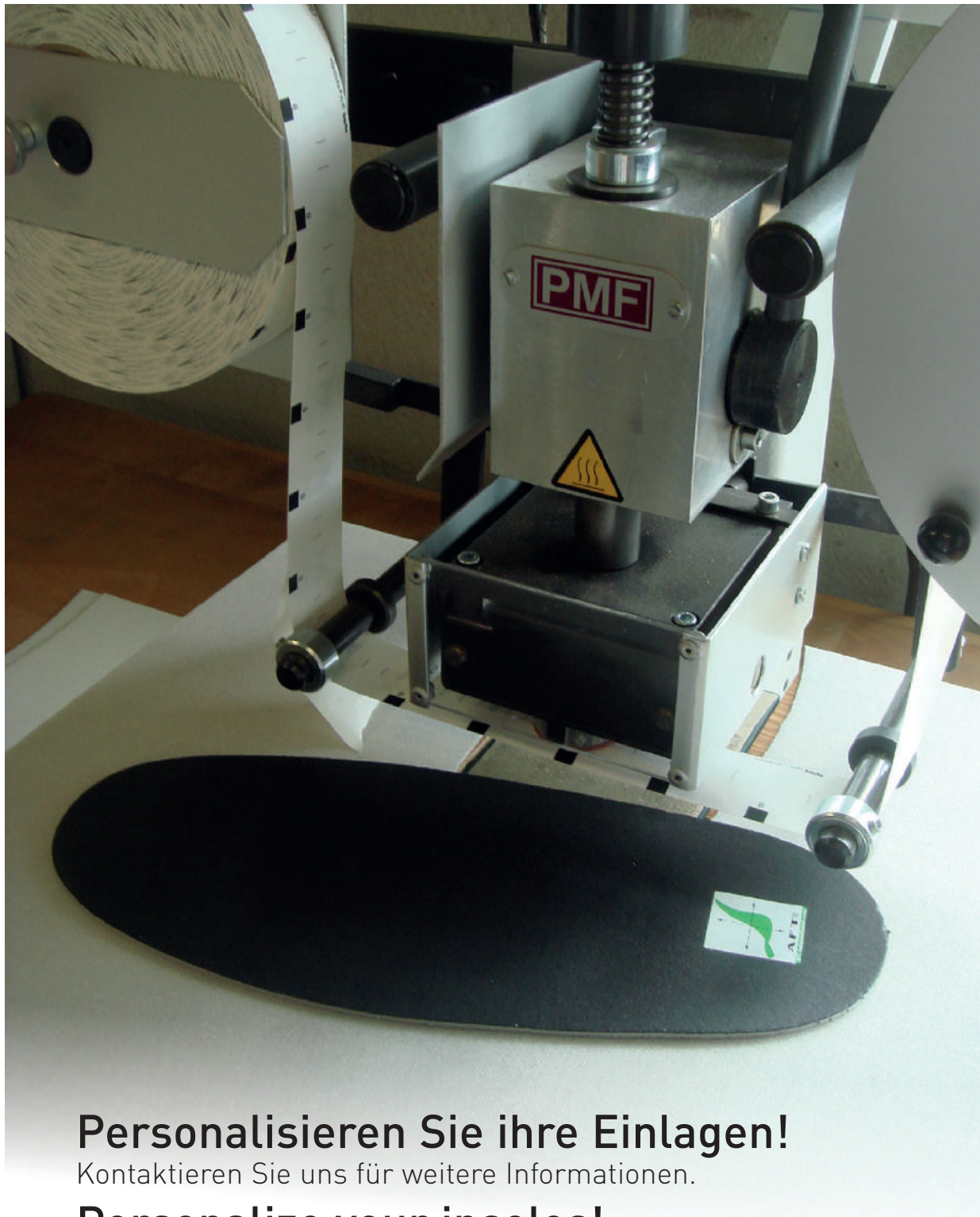

Personalisieren Sie ihre Einlagen!

Kontaktieren Sie uns für weitere Informationen.

Personalize your insoles!

Ask us for more details.

Personaliseer uw steunzolen!

Contacteer ons voor meer informatie.

Personaliser vos semelles orthopédiques!

Demandez-nous plus d'informations.

THERMYTEX 3592.



Thermo regulierend, anti-allergie, atmungsaktiv, feuchtigkeitsaustauschfähig, abwaschbar, Lederprint
 Thermo-regulating, anti-allergy, breathable, absorbent, washable, leather look
 Thermoregulerend, anti-allergie, luchtdoorlatend, vochtabsorberend, afwasbaar, lederlook
 Thermo regulatoire, anti-allergie, perméable, absorbant l'humidité, lavable, look cuir

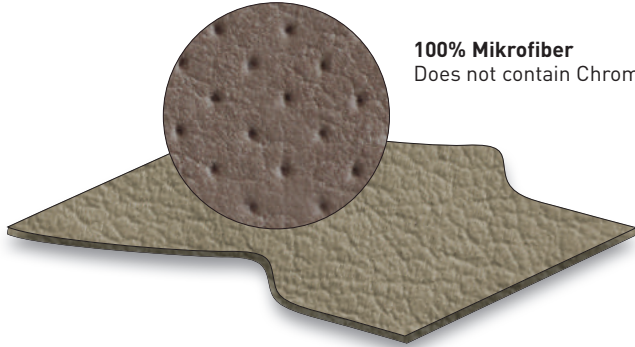

100% Mikrofiber
Does not contain Chrome 6

	0	5 *
	non perfo	perfo
	in 14 Farben in 14 colours in 14 kleuren en 14 couleurs	in 6 Farben in 6 colours in 6 kleuren en 6 couleurs



0	100 x 137cm - 0,8mm		•	•
1	11,5 cm x 25m - 0,8mm		•	•
2	140 cm x 50 m - 0,8mm		•	•



01 *	07 *	30	05 *	90	64	03 *
schwarz black zwart noir	dunkelgrau dark grey donker grijs gris foncé	platin platinum platina platine	hell beige light beige lichtbeige beige clair	champagne	kamel camel kameel chameau	taupe
12 *	18	42	47	33	25	13 *
kaffee coffee koffie café	oranje orange orange orange	rot red rood rouge	fuchsia	paars purple paars mauve	königsblau royal blue koningsblauw bleu royal	dunkelblau dark blue donkerblauw bleu foncé

**NEUE FARBEN
 NEW COLORS
 NIEUWE KLEUREN
 NOUVELLES COULEURS**

THERMY-POINT 3591.



Thermo regulierend, anti-allergie, atmungsaktiv, feuchtigkeitsaustauschfähig, abwaschbar, Lederprint
 Thermo-regulating, anti-allergy, breathable, absorbent, washable, leather look
 Thermoregulerend, anti-allergie, luchtdoorlatend, vochtabsorberend, afwasbaar, lederlook
 Thermo regulatoire, anti-allergie, perméable, absorbant l'humidité, lavable, look cuir

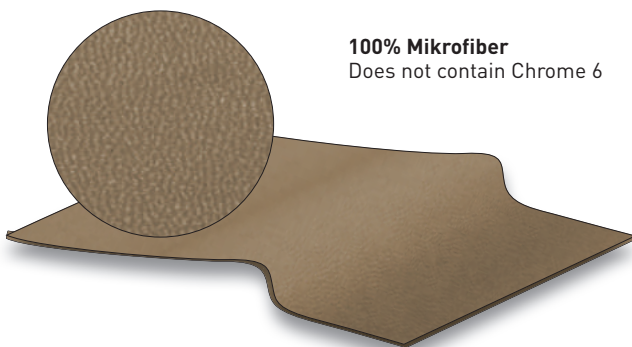

100% Mikrofiber
Does not contain Chrome 6

	0	
	non perfo	
	1	4
	schwarz black zwart noir	beige beige beige beige



0	100 x 137cm - 0,8mm		•	•
1	11,5 cm x 25m - 0,8mm		•	•
2	140 cm x 50 m - 0,8mm		•	•



SUETEX 3593.

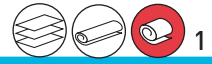

Abwaschbar, reißfest, hohe Zugkraft, atmungsaktiv, lichtbeständig, abriebfest, farbecht und wasserdampfdurchlässig
 Washable, strong, high tractive power, air transmittable, vapour transmittable, colourfast, friction fast
 Afwasbaar, schuift niet, hoge trekkracht, luchtdoorlatend, vochtdoorlatend, kleurecht, wrijfbestendig
 Lavable, résistant, haute force de traction, perméable de l'air et de l'humidité, anti-friction, fixe couleur

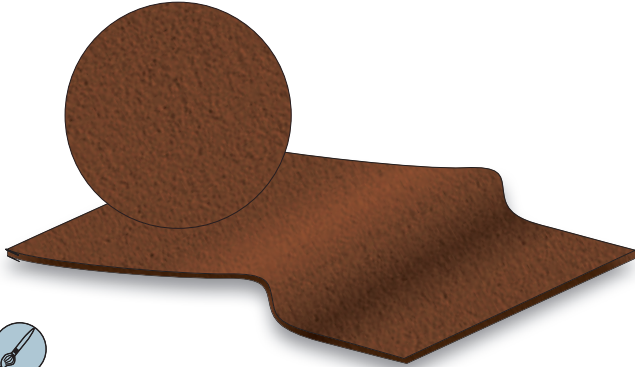

in 6 Farben
 all 6 colours
 alle 6 kleuren
 toutes les 6 couleurs



0	100 x 137cm - 0,7mm		•
1	11cm x 25m - 0,7mm		•
2	137cm x 50m - 0,7mm		•



00	17	01	03	05	11
schwarz black zwart noir	grau grey grijs gris	dunkelbraun dark brown donkerbruin brun foncé	hell beige light beige lichtbeige beige clair	dunkelblau dark blue donkerblauw bleu foncé	mittelbraun middle brown middelbruin brun moyen

CAMBRELL 3597.



Sehr dünne Bezugsstoffe für Einlagen
 Very thin covering tissue for inlays
 Zeer dun afdek materiaal voor steunzolen
 Tissu de recouvrement très mince pour des semelles orthopédiques



00	schwarz black zwart noir
09	rot red rood rouge



0	100 x 150cm - 0,5mm.		•	•
1	11,5cm x 50m - 0,5mm.		•	
2	150cm x 50m - 0,5mm.		•	

VILEDON 3595.



Sehr dünne Bezugsstoffe für die Unterseite von Einlagen
 Very thin covering tissue for the underside of inlays
 Zeer dun afdek materiaal voor onderkant steunzolen
 Tissu de recouvrement très mince pour le dessous des semelles orthopédiques

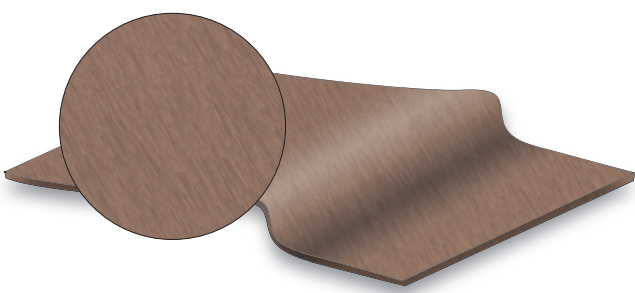

00	beige beige beige beige
----	----------------------------------



0	100 x 150cm - 0,5mm		•
1	12,5cm x ±50m - 0,5mm		•
2	150cm x ±50m - 0,5mm		•

Farbabweichungen zwischen dem Farbdruck und dem Originalprodukt sind möglich.
 Colour differences between print and original product are possible.
 Kleurverschillen tussen het drukwerk en het origineel product zijn mogelijk.
 Des différences de couleur entre l'imprimerie et la produit originale sont possible.

SKAILINA 3594.



Lederimitation ohne Profil, atmet, abwaschbar, hautfreundlich, sehr dünn und preisgünstig.
 Imitation leather without profile, breathes, washable, skin friendly, very thin and price worthy.
 Imitatieleder zonder profiel, ademt, afwasbaar, huidvriendelijk, zeer dun en gunstig van prijs.
 Imitation-cuir sans profile, lavable, respire, peau agréable, très fin et favorable.

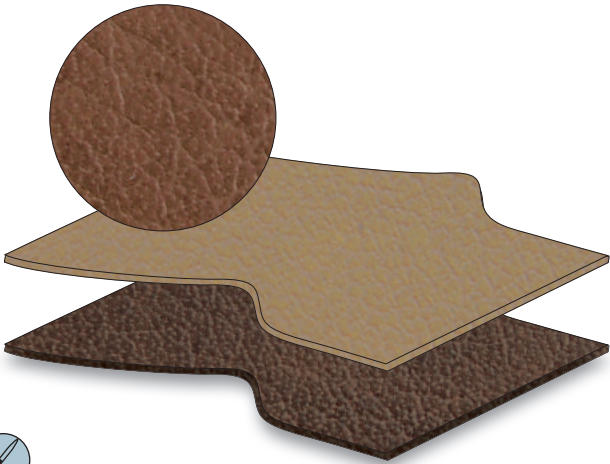

			03
			in 9 Farben all 9 colours alle 9 kleuren les 9 couleurs
			elfenbein ivory ivoor ivoir
1	11 cm x 50 m		•
4	11 cm x 50 m PERFO-SP		•



00	01	03	04	08	11	S1	S3	S4
schwarz black zwart noir	dunkelbraun dark brown donkerbruin brun foncé	elfenbein ivory ivoor ivoir	beige	grau grey grijs gris	natur natural naturel naturel	braun brown bruin brun	amber amber amber ambre	creme creme creme crème

LETEX 3590.



Baumwollgewebe-Bezugsstoff: abwaschbar, atmungsaktiv, reißfest, lichtecht, feuchtigkeitsaustauschfähig, kein Abfärben
 Cotton covering tissue: washable, air transmittable, strong, colourfast, absorbent
 Katoen geweven bekledingsstof: afwasbaar, luchtdoorlatend, schuift niet, kleurvast, vochtabsorberend
 Tissu de recouvrement en coton: lavable, perméable, résistant, couleur fixe, absorbant humidité

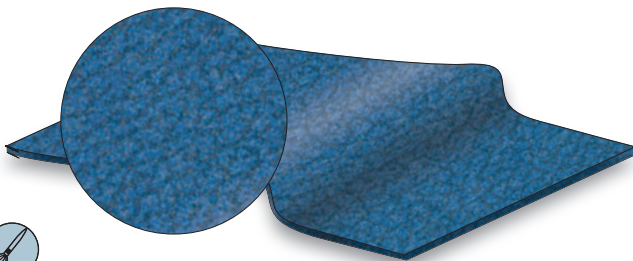

			in 4 Farben in 4 colours in 4 kleuren en 4 couleurs
0	100 x 145cm - 1 mm		•
1	11cm x 30m - 1 mm		•
2	145cm x 30m - 1 mm		•



00	17	11	08
schwarz black zwart noir	grau grey grijs gris	braun brown bruin brun	königsblau royal blue koningsblauw bleu royal



SKAI BRESTA 3581.

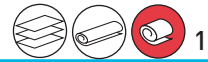

Dieses hochwertige Imitationsleder Variant ist ein Klassiker seiner Sorte. Durch seine lange Lebensdauer und gute Rissbeständigkeit ist dieses abwaschbare Material ideal geeignet zum Beschichten von Sohlen und für vieles mehr, z.B. zum Bekleiden von Sitzschalen.

This high quality imitation leather is a true classic in its sort. Due to the fact that it is long-lasting, tear-resistant and washable it is ideal to cover insoles. It can also be used for other purposes, for instance to cover seating.

Deze hoogwaardige imitatieleder variant is een ware klassieker. Door zijn lange levensduur, goede scheurbestendigheid en afwasbaarheid is het ideaal om zolen te bekleden. Ook geschikt voor andere toepassingen zoals het bekleden van zitschalen.

Cette cuir d'imitation d'haute qualité est un vrai classique dans son genre. Longue durée de vie - déchirure - facile à nettoyer. Egalement apte à d'autres applications comme des coquilles de siège.

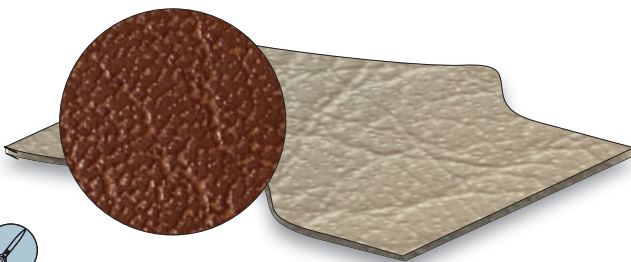

267*	270	301	460*
schwarz black zwart noir	palisander palisade palisande	havanna	wolle wool wol laine

NEU
NEW
NIEUW
NOUVEAU

in 4 Farben
in 4 colours
in 4 kleuren
in 4 couleurs

00	100 x 137cm - ±1 mm		●
10	11,5 cm x 30m - ±1 mm		●
20	137cm x 30m - ±1 mm		●
05	100 x 137cm - ±1 mm PERFO-SP		● *
15	11,5 cm x 30m - ±1 mm PERFO-SP		● *
25	137cm x 30m - ±1 mm PERFO-SP		● *

SKAI VENEZIA COOL 3582.



Das Skai venezia cool ist ausgestattet mit der 'cool color technology'. Es reduziert die Aufwärmung der Oberfläche beim reiben des Materials und erzeugt keine Wärme. Die nano-coating macht das Material resistent gegen extremes Wetter, UV und Schmutz, auch ideal zum Verwenden als Bekleidungsstoff für Sporteinlagen.

The skai Venezia cool features a 'cool color technology'. It reduces the heating of the surface when exposed to heat. The nano-coating makes the material resistant to extreme weather, UV and dirt; therefore it is ideal as a cover for sport insoles.

De skai venezia cool is uitgerust met 'cool color technology.' Het vermindert de opwarming van het oppervlak bij blootstelling aan warmte. De nano-coating maakt het materiaal resistent tegen extreem weer, UV en vuil, waardoor het ideaal is voor het bekleden van sportzolen.

Le skai venezia cool est équipé de la technologie des couleurs fraîches. Il réduit l'accumulation de chaleur. Le revêtement nano rend le matériau résistant aux intempéries extrêmes, aux UV et à la saleté, parfait pour le recouvrement des semelles de sport.



NEU
NEW
NIEUW
NOUVEAU

019
ocean
ocean
oceaan
océane

00	100 x 140cm - ±1 mm		●
10	11,5cm x 30m - ±1 mm		●
20	140cm x 30m - ±1 mm		●

Farbabweichungen zwischen dem Farbdruck und dem Originalprodukt sind möglich.
Colour differences between print and original product are possible.
Kleurverschillen tussen het drukwerk en het origineel product zijn mogelijk.
Des différences de couleur entre l'imprimerie et la produit originale sont possible.

SKAI MANO-S ELECTRO 3583.



1

ELEKTRISCHER LEITER – geeignet für Sicherheitsschuhe und Orthesen, die gegen elektrostatische Aufladung geschützt werden müssen. Problemlose Verarbeitung bei den üblichen Verfahren nähen, kleben und nageln.

ELECTRIC CONDUCTOR – Ideal for work shoes and orthopaedic insoles that need to be protected from electrostatic charge. Hassle-free operation in the usual procedures sewing, glueing and nailing.

ELECTRISCHE GELEIDER – Geschikt voor werkschoenen en steunzolen die beschermd moeten worden tegen elektrostatische lading. Probleemloze verwerking in de gebruikelijke procedures naaien, plakken en spijkeren.

CONDUCTEUR ÉLECTRIQUE - Convient pour des chaussures de travail et des semelles intérieures qui doivent être protégées contre les décharges électrostatiques. Traitement sans problème dans les procédures habituelles couture, coller et clouer.



NEU
NEW
NIEUW
NOUVEAU



486

schwarz
black
zwart
noir



100 x 137cm - ±1,1 mm



•



140cm x 30m - ±1,1 mm



•

60300002 AFT



1

Display für Bezugsstoffe auf Mini-Rollen
 Display for fabrics on mini rolls
 Display voor bekledings-stoffen op mini-rollen
 Présentoir pour tissus sur mini rouleaux

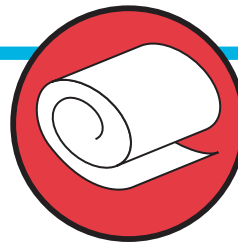

PPT
EVA MARBLE
THERMYTEX
THERMY-POINT
SUETEX
CAMBRELL
VILEDON
SKAILINA
LETEX
SKAI BRESTA

MINI-ROLLEN

Schneller arbeiten und weniger Verlust!

Work faster and less loss of material!

sneller werken en minder materiaalverlies

Travaillez plus vite et moins de perte de matériel

STELLEN SIE IHRE EIGENE KOMBINATION ZUSAMMEN!

MAKE YOUR OWN COMBINATION!

STEL UW EIGEN COMBINATIE SAMEN!

ASSEMBLEZ VOTRE PROPRE COMBINAISON!

Das Mini-Rollen Display erlaubt eine endlose Flexibilität. Wählen Sie 6 Rollen mit verschiedenen Stoffen, z.B.

The Mini-Roll system offers you a lot of flexibility. Choose 6 rolls of the above materials.

Met het Mini-Rol systeem geniet u van een eindeloze flexibiliteit. Kies zelf 6 rollen uit bovenstaande materialen.

En employant ce système vous bénéficiez d'une flexibilité super. Choisissez 6 rouleaux des matériaux ci-dessus.

MICROSPORT MTP 3572.



Microsport ist ein neues Material welches für die Fertigstellung eines Sportschuhs, einer Orthese oder auch als Polstermaterial verwendet wird.

100 x 130cm

Microsport is the new material for finishing sports shoes. The material is also used for finishing orthosis or as a padding material.

Microsport is het nieuw afwerkmetaal voor sportschoenen. Het materiaal wordt ook toegepast bij het afwerken van ortheses of als polsteringmateriaal.

Microsport est le nouveau matériel pour les chaussures de sport. Le matériau est également utilisé pour le finissage de l'orthèse ou comme matériau de rembourrage.

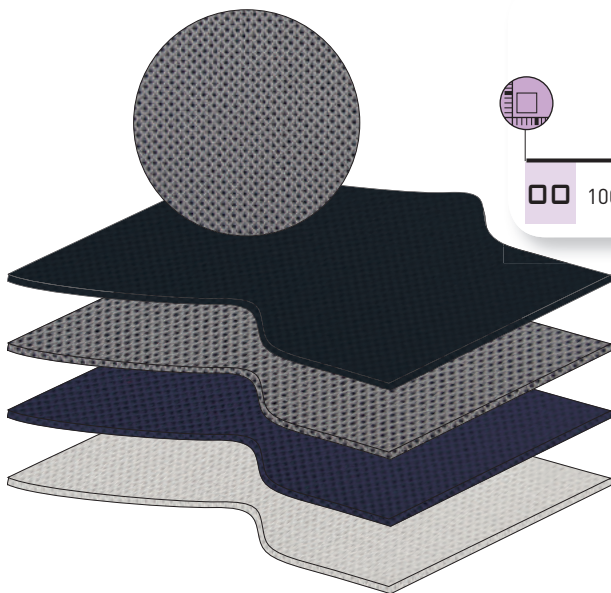

	00	02	05	06
	schwarz black zwart noir	silber silver zilver argent	nachtblau nightblue nachtblauw bleu nuit	weiss white wit blanc
00 100 x 130 cm	•	•	•	•

NEOSPORT 3596.



Neues Bezugsmaterial für orthopädische Sporeteinen aus angenehm stoßdämpfenden Neoprenmaterial und synthetischen Bezugsstoff. Sofort verwendbar. Vorbeugend gegen Blasen.

100 x 60cm

New sports covering material for insoles/orthotics in Neoprene, an agreeable shock absorber, with a synthetic fabric cover, which makes this material ready for use. Prevents blisters.

Nieuw sport-afdekmetaal voor zolen uit Neopreen, een aangename schokabsorbeerder, met een dunne gelamineerde synthetische toplaag, meteen gebruiksklaar om zolen af te dekken. Voorkomt blaren.

Nouveau matériau de sport pour recouvrir des semelles en Néoprène, un très bon matériau absorbant des chocs, avec recouvrement synthétique. Prêt à utiliser. Empêche les cloques

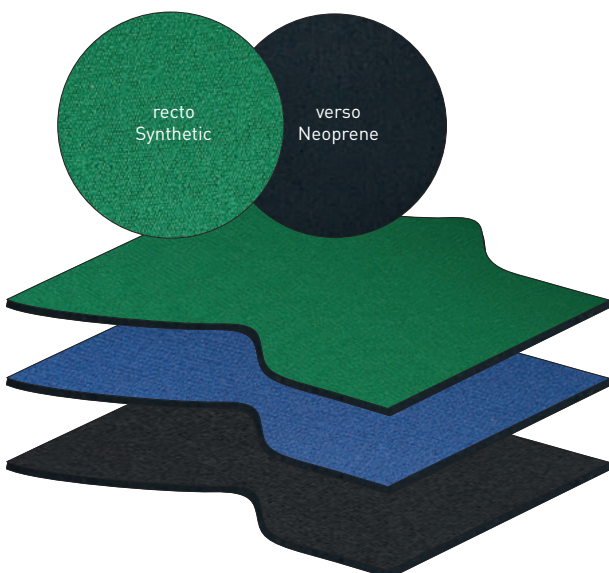

	0	7	8
	schwarz black zwart noir	grün green groen vert	blau blue blauw bleu
21 2,1 mm	•	•	•
32 3,2 mm	•	•	•

ORTHOPRENE 3598.



210 x 135cm

EINSEITIG
 ONE-SIDED
 ENKELZIJDIG
 UNE FAÇE

Einseitig textilbeschichtet, viele Farben möglich; Kletttaftung möglich.
Bei Bestellungen immer Farbnummer mit angeben!

One side covered with fabric, many colours available; velcro possible.
Please mention colour number when you place your order!

Eenzijdig met stof bekleed, grote kleurkeuze; klittenband mogelijk.
Bij bestelling steeds het kleurnummer vermelden!

Une face couverte de tissu dans un grand choix de couleurs; possibilité de velcro.
Veuillez indiquer le numéro de la couleur quand vous passez votre commande.

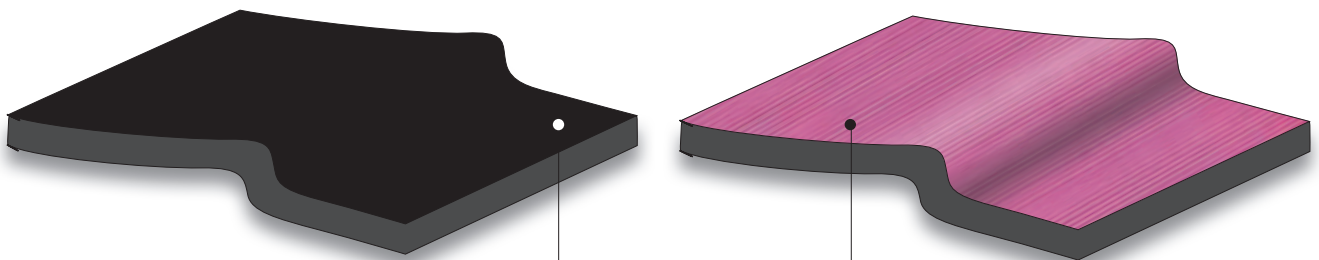

ORTHOPRENE
 = NEOPRENE

		1	2
		00	00
		eine Seite Orthoprene one side Orthoprene ene zijde Orthoprene une façade Orthoprene	Bezugsstoff 0,5mm. in 19 Farben fabric 0,5mm. all 19 colours bekledingsstof 0,5mm. alle 19 kleuren tissu 0,5mm. les 19 couleurs
02	2,0 mm	•	•
03	3,0 mm	•	•
04	4,0 mm	•	•
05	5,0 mm	•	•
06	6,0 mm	•	•
07	7,0 mm	•	•



ORTHOPRENE
 = NEOPRENE

Farbabweichungen zwischen dem Farbdruck und dem Originalprodukt sind möglich.
 Colour differences between print and original product are possible.
 Kleurverschillen tussen het drukwerk en het origineel produkt zijn mogelijk.
 Des différences de couleur entre l'imprimerie et la produit originale sont possible.

30	29	28	25	27	20	22	23	19
schwarz black zwart noir	dunkel Grau dark grey donkergrijs gris foncé	grau grey grijs gris	wollweiss eggshell gebroken wit blanc cassé	weiss white wit blanc	türkis turquoise turquoise	marine Blau navy blue marine blauw bleu marine	nacht Blau night blue nacht blauw bleu nuit	violett violet violet



ORTHOPRENE 3598.



210 x 135cm

**DOPPELSEITIG
DOUBLE SIDED
TWEEZIJDIG
DOUBLE FAÇE**

Beidseitig textilbeschichtet, viele Farbkombinationen möglich; Kletthaftung möglich.
Bei Bestellungen immer zwei Farbnummern mit angeben!

Both sides covered with fabric, colour combinations with various colours; velcro possible.
Please mention both colour numbers when you place your order!

Beide zijden met stof bekleed, vele kleurcombinaties mogelijk; klittenband mogelijk.
Bij bestelling steeds de beide kleurnummers opgeven!

Deux faces couvertes de tissu dans un grand choix de couleurs; possibilité de velcro.
Veuillez indiquer les deux numéros de couleurs quand vous passez votre commande.

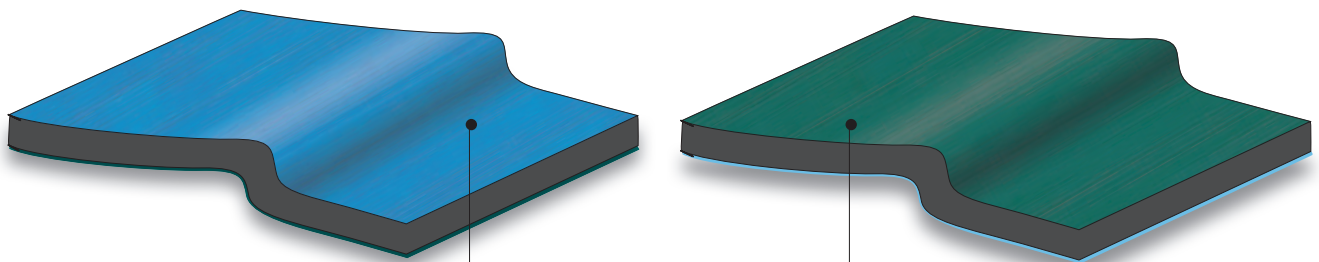

ORTHOPRENE
= NEOPRENE



Bezugsstoff 0,5mm. in 19 Farben
fabric 0,5mm. all 19 colours
bekledingsstof 0,5mm. alle 19 kleuren
tissu 0,5mm. les 19 couleurs

Bezugsstoff 0,5mm. in 19 Farben
fabric 0,5mm. all 19 colours
bekledingsstof 0,5mm. alle 19 kleuren
tissu 0,5mm. les 19 couleurs

02	2,0 mm	•	•
03	3,0 mm	•	•
04	4,0 mm	•	•
05	5,0 mm	•	•
06	6,0 mm	•	•
07	7,0 mm	•	•

Farbabweichungen zwischen dem Farbdruck und dem Originalprodukt sind möglich.
Colour differences between print and original product are possible.
Kleurverschillen tussen het drukwerk en het origineel product zijn mogelijk.
Des différences de couleur entre l'imprimerie et la produit originale sont possible.

26	16	14	12	08	07	01	02	05	04
braun brown bruin brun	rotbraun reddish brown roodbruin rouge brun	kirschrot cherry red kersrood rouge cerise	rot red rood rouge	neon Orange neon Orange neon oranje orange néon	gelb yellow geel jaune	neon Gelb neon yellow neon geel jaune néon	neon Grün neon green neon groen vert néon	olive Grün olive green olijfgroen vert olive	moos Grün moss-green mosgroen vert mousse

RUBBER 74200.



Elastischer gummi Rahmen
Elastic rubber welt
Elastische rubber rand
Trépointe élastique

76 x 3,4cm - 2mm



0	6
black	white

Bestellung pro 2 Paare (= 4 Längs)
Order per 2 pairs (= 4 lengths)
Afname per 2 paar (= 4 lengtes)
Commande par 2 paires (= 4 longueurs)

ZEPHIR RUBBER 7417120.



micro-cell gummi Rahmen
micro cell rubber welt
microcel rubber rand
Trépointe micro-cell-caoutchouc

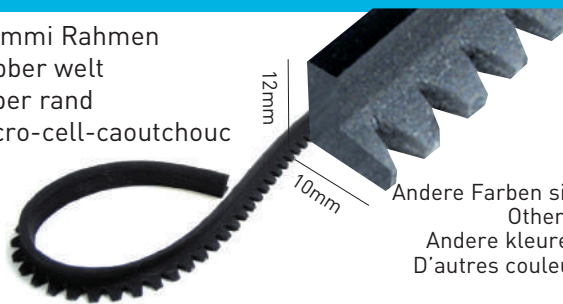

0	1	6	7
black	d.brown	white	caramel

Andere Farben sind lieferbar ab einer Bestellmenge von min. 25m.
Other colours are available per minimum order of 25m.
Andere kleuren verkrijgbaar op bestelling vanaf minimum 25m.
D'autres couleurs sont livrables sur commande, à partir de 25m.

PORO 7414.



7415.



Runde Krempe
round border
ronde boord
bord ronde

Breite Krempe
large border
brede boord
bord large



HARDAIR

in 16 Farben
all 16 colours
alle 16 kleuren
toutes les 16 couleurs

Andere Formen sind lieferbar ab einer Bestellmenge von min. 100m.
Other models are available per minimum order of 100m.

Andere modellen verkrijgbaar op bestelling vanaf minimum 100m.
D'autres modèles sont livrables sur commande, à partir de 100m par référence.



PORO HARDAIR

109	111	166	197	181	105	189	187
weiß white wit blanc	hellgrau light grey lichtgrijs gris clair	mittelgrau medium grey middelgrijs gris moyen	dunkelgrau dark grey donkergrijs gris foncé	schwarz black zwart noir	hellbeige light beige lichtbeige beige clair	arena	tierra
135	185	122	198	146	106	178	159
beige	taupe antelope leverbeige gabardine	hellbraun light brown lichtbruin brun clair	otter	dunkelbraun dark brown donkerbruin brun foncé	rot red rood rouge	dunkelblau dark blue donkerblauw bleu foncé	dunkelgrün dark green donkergroen vert foncé

Farbabweichungen zwischen dem Farbdruck und dem Originalprodukt sind möglich.
Colour differences between print and original product are possible.
Kleurverschillen tussen het drukwerk en het origineel product zijn mogelijk.
Des différences de couleur entre l'imprimerie et le produit originale sont possible.



gezahnt
toothed
getand
dentelé



0	1
black	brown

		10	•	•
		20	•	•
		24	•	•
		25	•	•
		26	•	•
			7 black + green	
		27	•	•
		28	•	•
		29	•	•
		30	•	•
		35	•	•
		36	•	•



0	1	4
black	brown	natural

























		37	•	•	
		38	•	•	
		39	•	•	
		40	•	•	
		41	•	•	
		42	•	•	
		43	•	•	
		44	•	•	
		45	•	•	
		50	•	•	•
		60	•	•	•
		61	•	•	

7410.

























1m

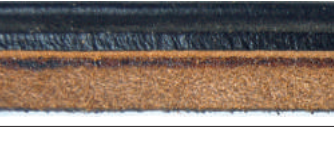

LEDER - LEATHER - LEADER - CUIR

gezahnt toothed getand dentelé		 		0	1	4
				black	brown	natural
		02	<input type="checkbox"/>	<input type="checkbox"/>	<input type="checkbox"/>	
		04	<input type="checkbox"/>	<input type="checkbox"/>	<input type="checkbox"/>	
		11	<input type="checkbox"/>	<input type="checkbox"/>	<input type="checkbox"/>	
		12	<input type="checkbox"/>	<input type="checkbox"/>	<input type="checkbox"/>	
		21	<input type="checkbox"/>	<input type="checkbox"/>	<input type="checkbox"/>	
		22	<input type="checkbox"/>	<input type="checkbox"/>	<input type="checkbox"/>	
		23	<input type="checkbox"/>	<input type="checkbox"/>	<input type="checkbox"/>	
		25	<input type="checkbox"/>	<input type="checkbox"/>	<input type="checkbox"/>	
		30	<input type="checkbox"/>	<input type="checkbox"/>	<input type="checkbox"/>	
		35	<input type="checkbox"/>	<input type="checkbox"/>	<input type="checkbox"/>	
		40	<input type="checkbox"/>	<input type="checkbox"/>	<input type="checkbox"/>	

LEDER - LEATHER - LEADER - CUIR

glatt
smooth
vlak
lisse

				0	1	4
				black	brown	natural
		02		•	•	•
		21		•	•	•
		23		•	•	•
		24		•	•	
		29		•	•	•
		30		•	•	
		35		•	•	•
		37		•	•	
		38		•	•	
		59		•		•
		65		•	•	

				0	1	4
				black	brown	natural
50		6 mm 7 mm			6 mm 7 mm	6 mm 7 mm 16 mm 18 mm

Farbabweichungen zwischen dem Farbdruck und dem Originalprodukt sind möglich.
 Colour differences between print and original product are possible.
 Kleurverschillen tussen het drukwerk en het origineel produkt zijn mogelijk.
 Des différences de couleur entre l'imprimerie et la produit originale sont possible.

**ABSÄTZE, SOHLEN, STREIFEN
HEELS, SOLES, STRIPES
HAKKEN, ZOLEN, STROKEN
TALONS, SEMELLES, BANDES DÉCOUPÉES**



AFT[®]
AFT-International.com



2.01	STIFTFLECKE DOWEL LIFTS STIFTHAKKEN BONBOUTS À TIGE	2.2
2.02	ABSÄTZE HEELS HAKKEN TALON	2.4
2.03	STREIFEN STRIPES STROKEN BANDES DÉCOUPÉS	2.9
2.04	KEILSTREIFEN RUBBER STRIPES SCHUINE STROKEN BANDES BISEAUTÉES	2.13
2.05	SOHLEN SOLES ZOLEN SEMELLES	2.14
2.06	VIBRAM PLATTEN VIBRAM SHEETS VIBRAM PLATEN VIBRAM PLAQUES	2.18
2.07	VIBRAM 1/1 PROFILLANGSOHLEN VIBRAM 1/1 PROFILE LONG SOLES VIBRAM 1/1 PROFIELZOLEN VIBRAM 1/1 SEMELLES PROFILÉES	2.21
2.08	VIBRAM 1/2 PROFILSOHLEN VIBRAM 1/2 PROFILE SOLES VIBRAM 1/2 PROFIELZOLEN VIBRAM 1/2 SEMELLES PROFILÉES	2.27
2.09	VIBRAM FORMABSÄTZE VIBRAM MOULDED HEELS VIBRAM GEVORMDE HAKKEN VIBRAM TALONS MOULÉS	2.29
2.10	PROFILLANGSOHLEN PROFILE LONG SOLES PROFIELZOLEN SEMELLES PROFILÉES	2.31

SUPERTAP 1202.

50p.

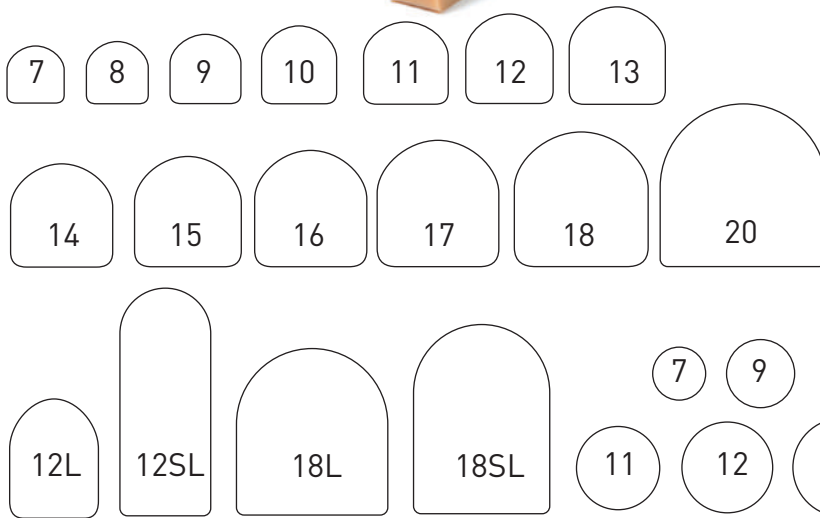

18x34 mm
1202234 schwarz/black/zwart/noir
1202634 beige

10 p.

27x24 mm
1202227 schwarz/black/zwart/noir
1202627 beige

	0	4
	schwarz black zwart noir	beige beige beige beige
07	●	
08	●	
09-18	●	●
20	●	●
12L	1202112L	
12SL	1202212SL	
18L	1202118L	1202518L
18SL	1202218SL	1202618SL

	8
	weiß white wit blanc
09	●
11	●
13	●
15	●

	3 THIN-PIN	7 THIN-PIN
	schwarz black zwart noir	beige beige beige beige
10	●	●
14	●	●

	RO
	schwarz black zwart noir
07	Ø 7 mm ●
09	Ø 9 mm ●
11	Ø 11 mm ●
12	Ø 12 mm ●
13	Ø 13 mm ●



Dose/box/doos/boîte, 235p.

Art. Nr. 1202000



1. stiftlecke messing
dowel lifts messing
stifthakken messing
bonbouts à tige messing

 12p.

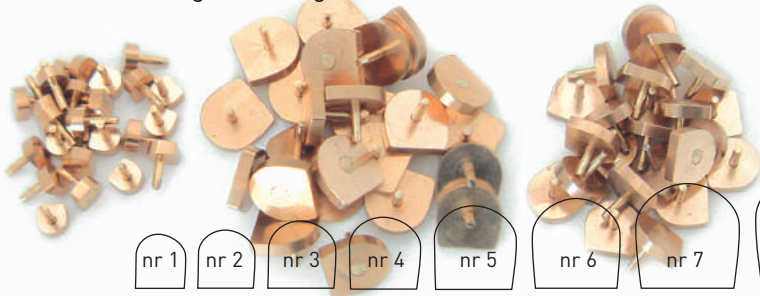

nr 1 120409-01

bis/to/tot/jusqu'à

nr 10 120409-10

2. Schwermetallhülsen EXTRA
Heavy metal dowels
Stalen buisjes
Goupilles métalliques

Ø 2,8 x 50mm - 100 ex.

4410

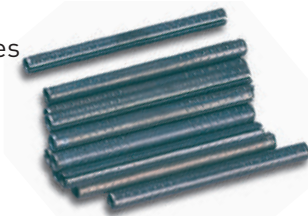

3. Metall-spannhülsen EXTRA
Flexible metal tubes
Metalen spanhuls
Chevilles en métal souple

Ø 2,8 mm - 100 ex.

4420



4. Hülsendurchschläger EXTRA
Dowel punching tool
Doorslag met huls
Chasse-goupilles

Ø 2,8mm

6076004000



5. Bohrer für Damenabsätze
Drill for ladies' heels
Boortjes voor dameshakken
Mèche pour talons dames

Rechts/right/rechts/droite 2,8mm 10p. 8001

Links/left/links/gauche 2,8mm 1p. 8002



6. Holzdübel EXTRA
Wooden dowels
Ronde houten stokjes
Baguettes rondes en bois

aan30% **0,5kg**

L = 40mm - 0,5kg

Ø3mm 83630

Ø4mm 83640

Ø5mm 83650

Ø6mm 83660



7. Holznägel EXTRA
Wooden pins
Houten pinnen
Chevilles en bois

aan30% **0,5kg**

5 x 8mm 8305

7 x 9mm 8307

8 x 8mm 8308

5/5 x 34mm 8334

4 x 42mm 8342



2.02

ABSÄTZE
HEELS
HAKKEN
TALON

MASSIVE 1239.13



FORMABSATZ - MOULDED HEEL - GEVORMDE HAK - TALON MOULÉ

100%

NEU
NEW
NIEUW
NOUVEAU

10



	<input type="checkbox"/>	1
	schwarz black zwart noir	braun brown bruin brun
	9 mm	
13	•	•

RODI 1251.

FORMABSATZ - MOULDED HEEL - GEVORMDE HAK - TALON MOULÉ

100%

NEU
NEW
NIEUW
NOUVEAU



	053	083	093
	blau blue blauw bleu	oranje orange oranje orange	rot red rood rouge
NR3	•	•	•



> page 2.16

TRAPPER 1253.

FORMABSATZ - MOULDED HEEL - GEVORMDE HAK - TALON MOULÉ

100%

NEU
NEW
NIEUW
NOUVEAU



	054	084	094
	blau blue blauw bleu	oranje orange oranje orange	rot red rood rouge
NR4	•	•	•





> page 2.17

ITALY 12406.

10

FORMABSATZ - MOULDED HEEL - GEVORMDE HAK - TALON MOULÉ





			
	6 mm		schwarz/beige black/beige zwart/beige noir/beige
03	3		•
04	4		•

MEZZO 12408.

10

FORMABSATZ - MOULDED HEEL - GEVORMDE HAK - TALON MOULÉ



			
	8 mm		schwarz/beige black/beige zwart/beige noir/beige
03	3		•
04	4		•

TRADITION 121.



40

FORMABSATZ - MOULDED HEEL - GEVORMDE HAK - TALON MOULÉ



	6		7		
	6 mm		7 mm		
	0	1	0	1	4
	schwarz black zwart noir	braun brown bruin brun	schwarz black zwart noir	braun brown bruin brun	beige beige beige beige
01	•	•	•	•	•
02	•	•	•	•	•
03	•	•	•	•	•
04	•	•	•	•	•
05			•	•	•

MONTE ROSA 1237.



20

FORMABSATZ - MOULDED HEEL - GEVORMDE HAK - TALON MOULÉ

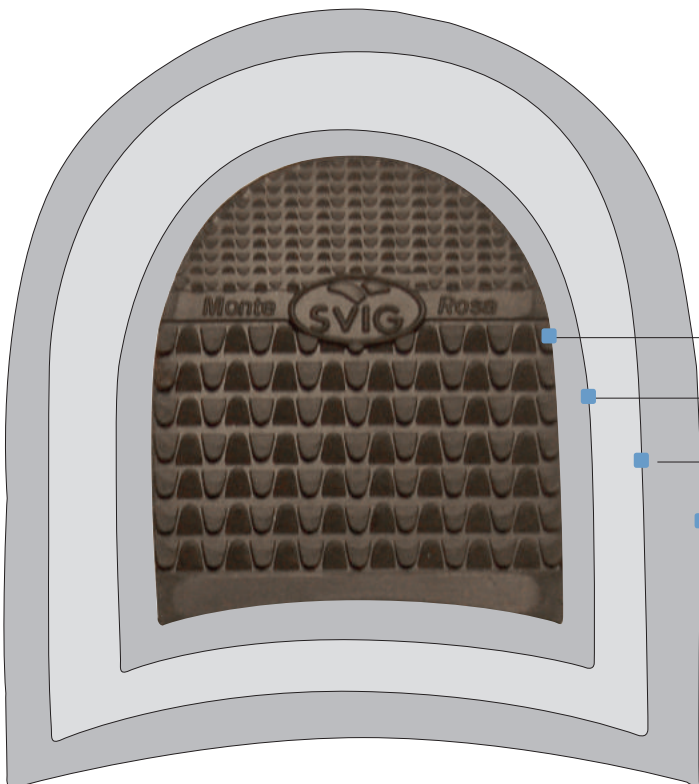





	0	1	7
7 mm	schwarz black zwart noir	braun brown bruin brun	karamell toffee karamel caramel
00	•	•	
01	•	•	•
02	•	•	•
04	•	•	•



> page 2.19





CROWN 1001.    

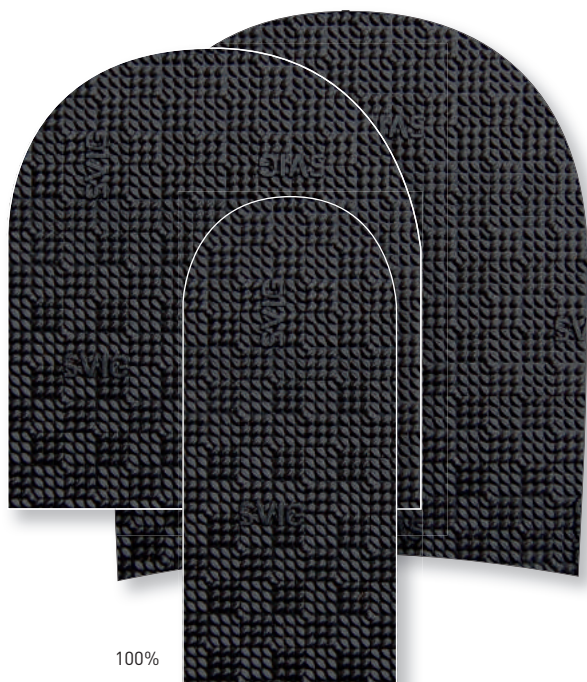

	2	3		
	per KG by kg per kg par kg	per 50 Paar by 50 pair per 50 paar par 50 pairs		
	505 (=5L) > 513 (=13L) 14 > 25 24D > 50D			 > part 11.01
		0	1	
	schwarz black zwart noir	braun brown bruin brun	beige beige beige beige	
	6 6,0 mm	●	●	●
	8 8,0 mm		●	
	9 10,0 mm		●	

DUO-TOP 1004.    



	2	3		
	per KG by kg per kg par kg	per 50 Paar by 50 pair per 50 paar par 50 pairs		
	505 (=5L) > 513 (=13L) 14 > 25 24D > 50D			 > part 11.01
		0	1	
	schwarz black zwart noir	braun brown bruin brun	karamell toffee karamel caramel	
	6 6,0 mm	●	●	●

VKL 115.



- kg

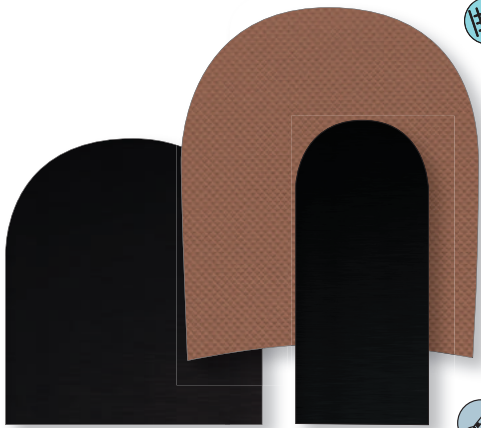

0	1	5
VKL glatt smooth glad lisse + Gummi rubber rubber caoutchouc	VKL glatt smooth glad lisse + Leder leather leder cuir	VKL Diamant diamant diamant diamant + Gummi rubber rubber caoutchouc
4,5 mm	4,5 mm	4,5 mm
1,2 mm	1,2 mm	1,2 mm

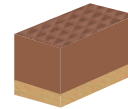
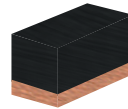
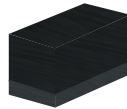

> part 11.01

0	1	0	1	0	1	4
schwarz black zwart noir	braun brown bruin brun	schwarz black zwart noir	braun brown bruin brun	schwarz black zwart noir	braun brown bruin brun	beige beige beige beige

505 > 513

008 > 025

024D > 050D

GUM-TOP 1009.



100%



> part 11.01

2	3
per KG by kg per kg par kg	per 50 Paar by 50 pair per 50 paar par 50 pairs

6
6,0 mm

0	1
schwarz black zwart noir	braun brown bruin brun

505 > 513

14 > 25

24D > 50D

CREPINA SOFT 1005.



Shore A60

CREPINA HARD 1006.



Shore A95

100%



2	3
per KG by kg per kg par kg	per 50 Paar by 50 pair per 50 paar par 50 pairs



6
6,0 mm



in 16 Farben
all 16 colours
alle 16 kleuren
toutes les 16 couleurs



505 > 513	●
14 > 25	●
24D > 50D	●



> part 11.01





CREPINA SOFT, CREPINA HARD

109	111	166	197	181	105	189	187
weiß white wit blanc	hellgrau light grey lichtgrijs gris clair	mittelgrau medium grey middelgrijs gris moyen	dunkelgrau dark grey donkergrijs gris foncé	schwarz black zwart noir	hellbeige light beige lichtbeige beige clair	arena	tierra
135	185	122	198	146	106	178	159
beige	taupe antelope leverbruin gabardine	hellbraun light brown lichtbruin brun clair	otter	dunkelbraun dark brown donkerbruin brun foncé	rot red rood rouge	dunkelblau dark blue donkerblauw bleu foncé	dunkelgrün dark green donkergroen vert foncé

CREPINA SOFT 1356.     10

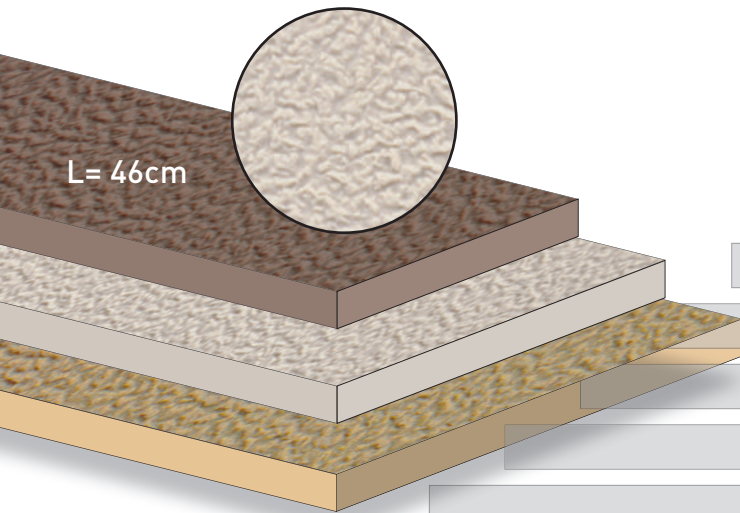
CREPINA HARD 1357.     10



 **6**
6 mm



in 16 Farben
all 16 colours
alle 16 kleuren
toutes les 16 couleurs

30	30 mm	•
40	40 mm	•
50	50 mm	•
60	60 mm	•
70	70 mm	•
70	70 mm	*
80	80 mm	•
90	90 mm	•
99	100 mm	•

*

1x	2x	1x	2x	1x	1x	2x	1x	1x
109	105	122	135	166	178	187	189	198

* farblich sortiert / colour assorted / kleurassortiment / assort. de couleurs:
SOFT: 1356670AS
HARD: 1357670AS

DIAMANTINO FINE 135365.   10

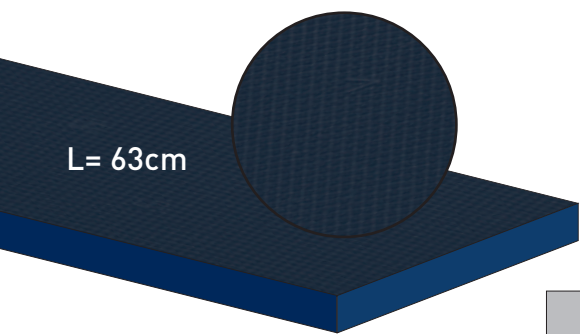

 **6**
6 mm



 **5**
blau
blue
blauw
bleu

60	60 mm	•
70	70 mm	•
80	80 mm	•
85	85 mm	•
90	90 mm	•

CROWN 1354.

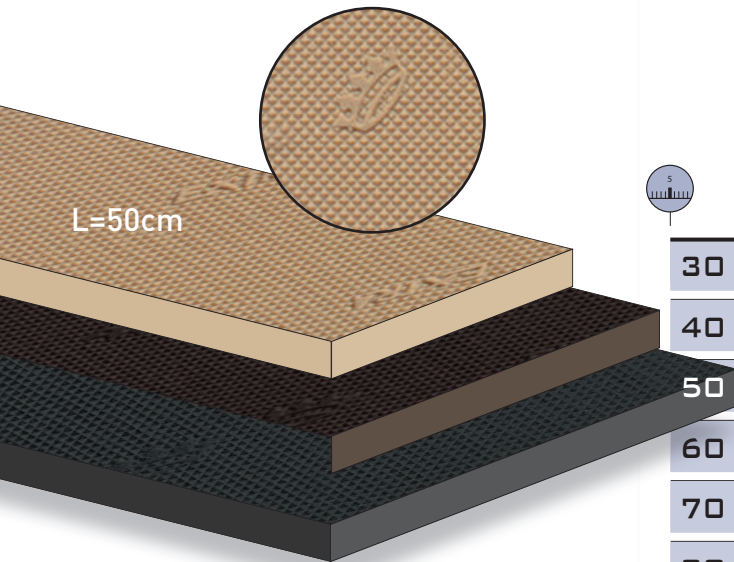

6	8	9
6 mm	8 mm	10 mm
		5



0	1	4	1	1
schwarz black zwart noir	braun brown bruin brun	beige beige beige beige	braun brown bruin brun	braun brown bruin brun



30	30 mm	•	•	•	•	•
40	40 mm	•	•	•	•	•
50	50 mm	•	•	•	•	•
60	60 mm	•	•	•	•	•
70	70 mm	•	•	•	•	•
80	80 mm	•	•	•	•	•
90	90 mm	•	•	•	•	•
99	100 mm	•	•	•	•	•

MEXICO DIAMANTINO 13536.

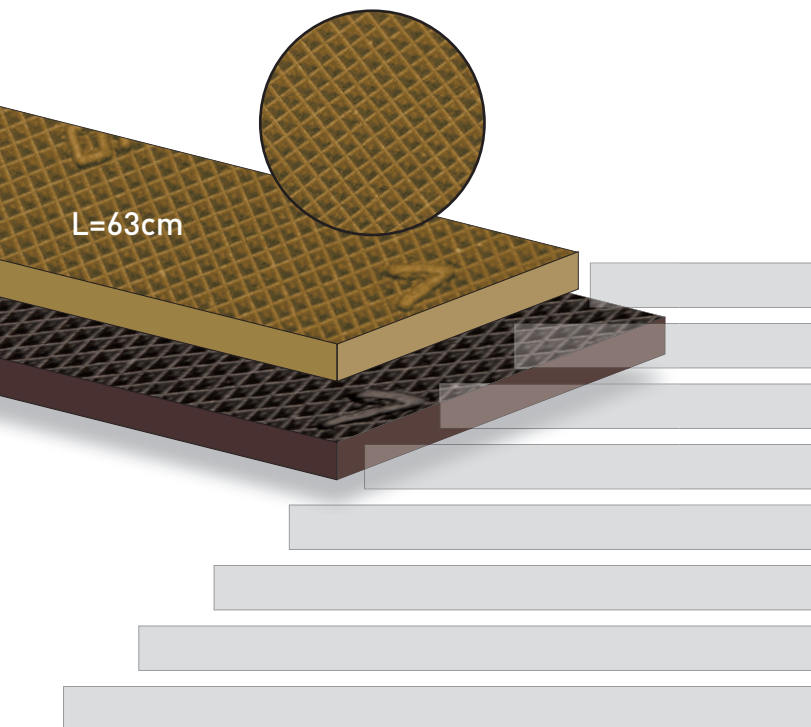

6
6 mm



0	1	7
schwarz black zwart noir	braun brown bruin brun	karamell toffee karamel caramel



30	30 mm	•	•	•
40	40 mm	•	•	•
50	50 mm	•	•	•
60	60 mm	•	•	•
70	70 mm	•	•	•
80	80 mm	•	•	•
90	90 mm	•	•	•
99	100 mm	•	•	•



		0		1		5		
		VKL +	4,5mm 1,2mm	VKL +	4,5mm 1,2mm	VKL-D +	4,5mm 1,2mm	
		Gummi rubber rubber caoutchouc		Leder leather leder cuir		Gummi rubber rubber caoutchouc		
		0	1	0	1	0	1	4
		schwarz black zwart noir	braun brown bruin brun	schwarz black zwart noir	braun brown bruin brun	schwarz black zwart noir	braun brown bruin brun	beige beige beige beige
15	15 mm	•	•	•	•	•	•	•
20	20 mm	•	•	•	•	•	•	•
25	25 mm	•	•	•	•	•	•	•
30	30 mm	•	•	•	•	•	•	•
35	35 mm	•	•	•	•	•	•	•
40	40 mm	•	•	•	•	•	•	•
50	50 mm	•	•	•	•	•	•	•
60	60 mm	•	•	•	•	•	•	•

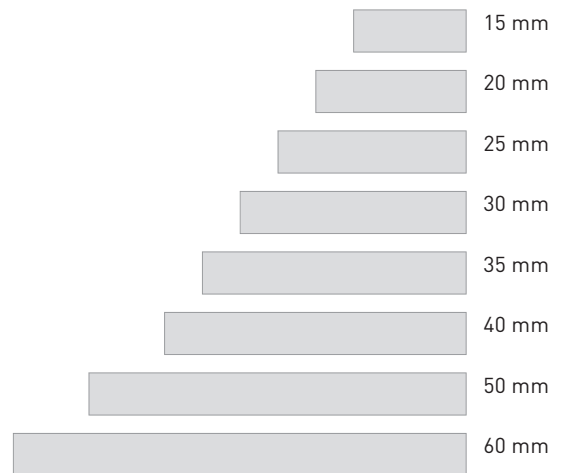
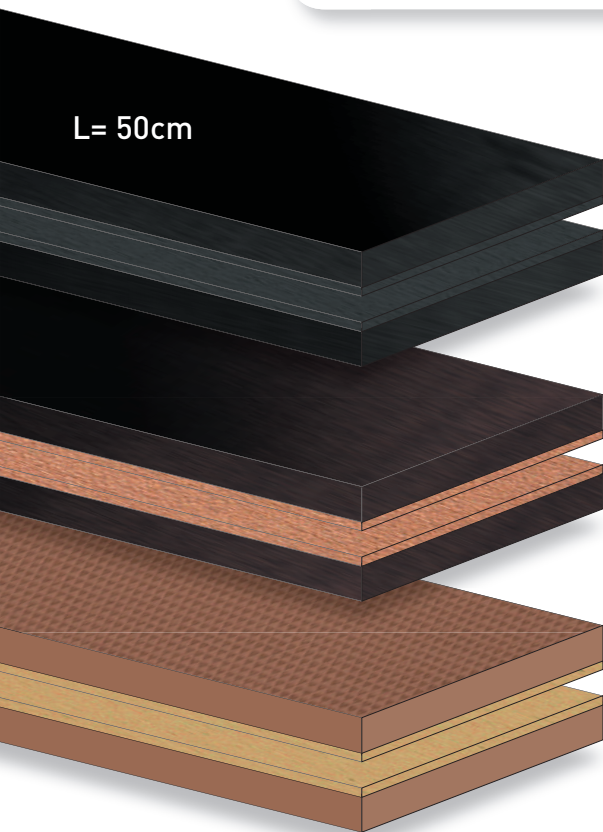

DUO-TOP 1355.

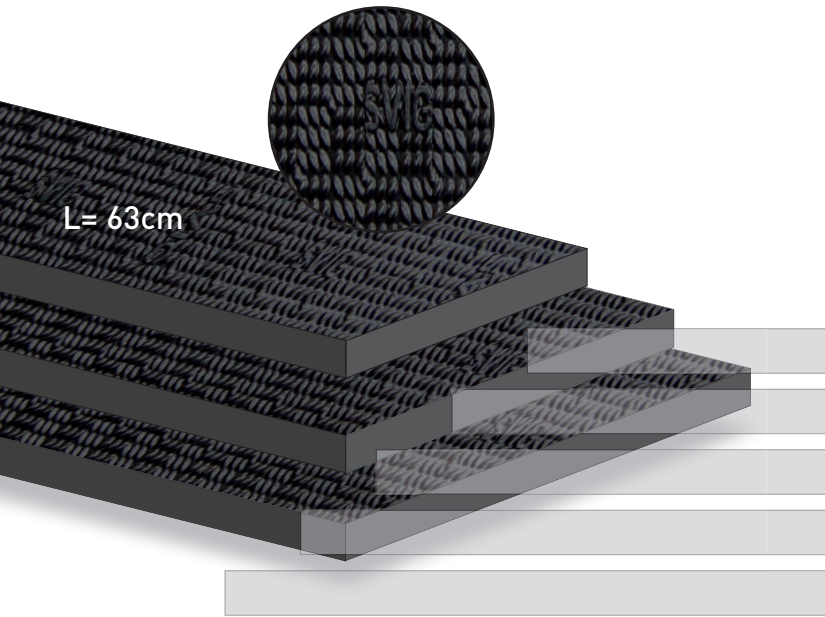

		6		
		6 mm		
		0	1	7
		schwarz black zwart noir	braun brown bruin brun	karamell toffee karamel caramel
40	40 mm	•	•	•
50	50 mm	•	•	•
60	60 mm	•	•	•
70	70 mm	•	•	•
80	80 mm	•	•	•

GUM-TOP 1352.

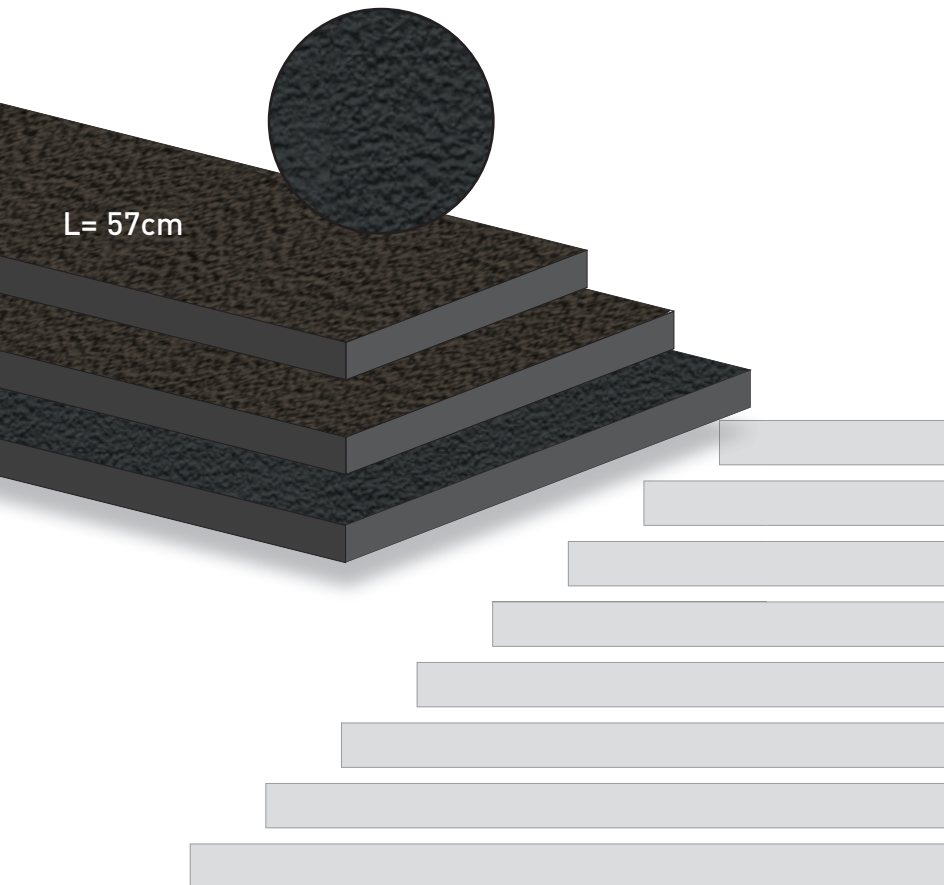

		6	
		6 mm	
		0	1
		schwarz black zwart noir	braun brown bruin brun
30	30 mm	•	•
40	40 mm	•	•
50	50 mm	•	•
60	60 mm	•	•
70	70 mm	•	•
80	80 mm	•	•
90	90 mm	•	•
99	100 mm	•	•

CREPINA 1431.

ABSATZ - HEEL - HAK - TALON

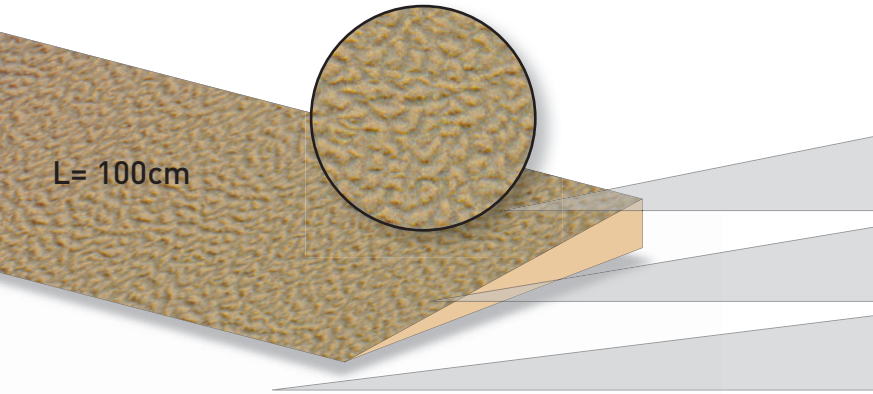

		> page 2.8	
		in 5 Farben	105, 109,
		all 5 colours	
		alle 5 kleuren	135, 146,
		les 5 couleurs	181
05	10 x 50 mm	•	
06	10 x 60 mm	•	
08	10 x 80 mm	•	

CROWN 1421.

ABSATZ - HEEL - HAK - TALON

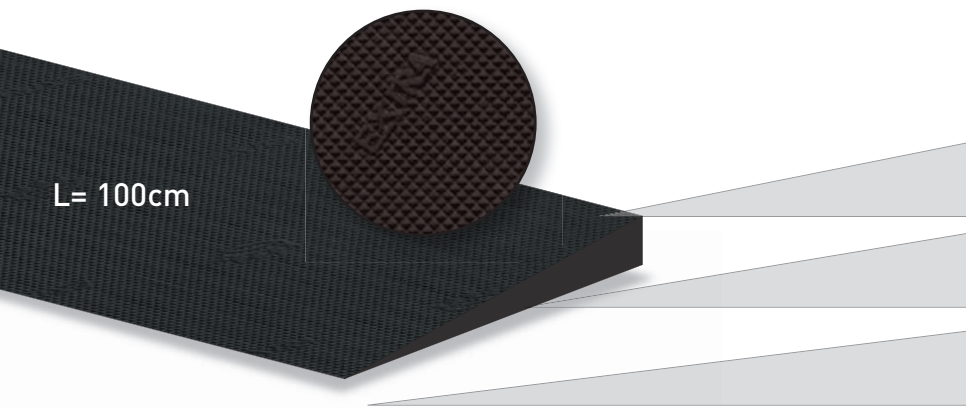

		0	1
		schwarz	braun
		black	brown
		zwart	bruin
		noir	brun
05	10 x 50 mm	•	•
06	10 x 60 mm	•	•
08	10 x 80 mm	•	•

STRONG 1441.

ABSATZ - HEEL - HAK - TALON



		0	1
		schwarz	braun
		black	brown
		zwart	bruin
		noir	brun
06	15 x 60 mm	•	•

TRESS 1410.

ZEHE - TOE - TEEN - ORTEIL

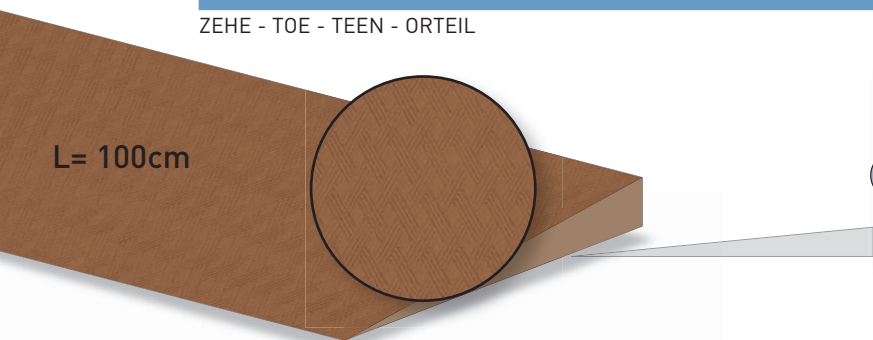

		0	1	4
		schwarz	braun	beige
		black	brown	beige
		zwart	bruin	beige
		noir	brun	beige
44	4 x 40 mm	•	•	•

2.05

1/2 SOHLEN
1/2 SOLES
1/2 ZOLEN
1/2 SEMELLES



RODI 15041. 

NEU
NEW
NIEUW
NOUVEAU

 10

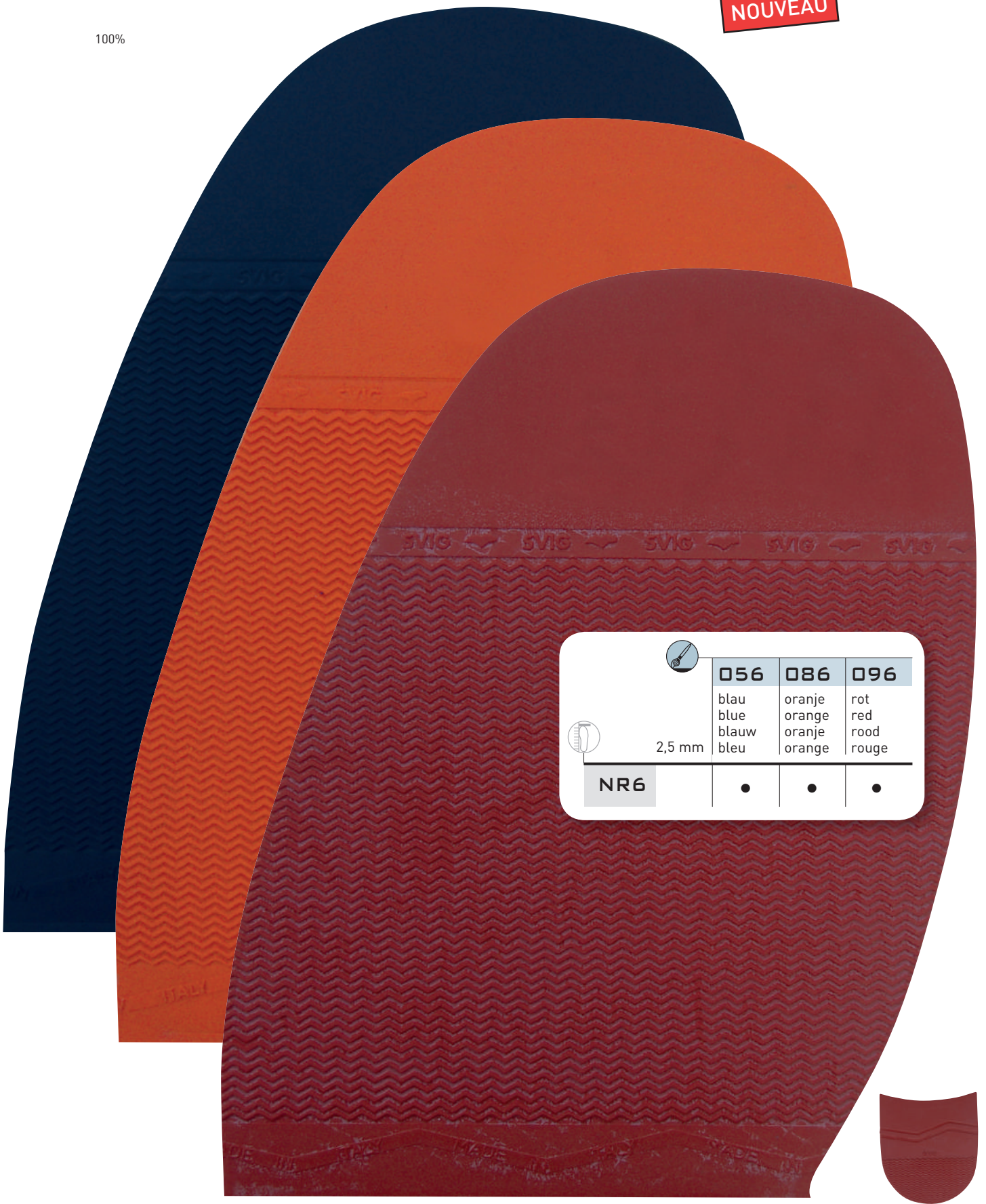
100%



	056	086	096
	blau blue blauw bleu	oranje orange oranje orange	rot red rood rouge
 2,5 mm			
NR6	•	•	•



> page 2.5

TRAPPER 15043.



**NEU
NEW
NIEUW
NOUVEAU**

 10



100%



	055	085	095
	blau blue blauw bleu	oranje orange oranje orange	rot red rood rouge
	NR5	•	•



> page 2.5

2.05

1/2 SOHLEN
1/2 SOLES
1/2 ZOLEN
1/2 SEMELLES

LAURA 1502.



20p.



2			5			6		
Damen breit 'D-L'			Herren normal			Herren breit 'L'		
women wide			men normal			men wide		
dames breed			heren normaal			heren breed		
dames large			hommes normal			hommes large		
39-41			43-46			43-46		



0	1	7	0	1	7	0	1	7
schwarz	braun	d.beige	schwarz	braun	d. beige	schwarz	braun	d. beige
black	brown	d. beige	black	brown	d. beige	black	brown	d. beige
zwart	bruin	d. beige	zwart	bruin	d. beige	zwart	bruin	d. beige
noir	brun	beige f.	noir	brun	beige f.	noir	brun	beige f.



20	2,0 mm	•	•	•	•	•	•	•	•
25	2,5 mm	•	•	•	•	•	•	•	•
30	3,0 mm	•	•	•	•	•	•	•	•
40	4,0 mm	•	•	•	•	•	•	•	•

100%

5



200%

2

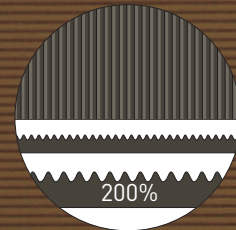

200%

6

MONTE ROSA 1503.

20p.

3,5 mm



		0	1	7
		schwarz black zwart noir	braun brown bruin brun	karamell toffee karamel caramel
03	3	●	●	●
05	5	●	●	●



> page 2.7

FLYING MAN 15039.

20p.

3,5 mm



		0		
		schwarz black zwart noir		
		5	6	
		Herren normal men normal heren normaal hommes normal 43-46	Herren extra breit men extra wide heren extra breed hommes extra large 43-46	
35	3,5 mm	●	●	

2.05

1/2 SOHLEN
1/2 SOLES
1/2 ZOLEN
1/2 SEMELLES

Vielfalt von 2 Platten (links/rechts) pro Größe
Produced per 2 sheets (left/right) per size
Veelvoud van 2 platen (links/rechts) per maat
Production par 2 plaques (gauche/droite) par taille

DUO-TOP 1507.



0 > 6

in 8 Größe DO bis H6
all 8 sizes DO to H6
alle 8 maten DO tot H6
les 8 pointures DO jusqu' à H6



0	1	7
schwarz black zwart noir	braun brown bruin brun	karamell toffee karamel caramel



18

1,8 mm



CROWN 1505.



20p.

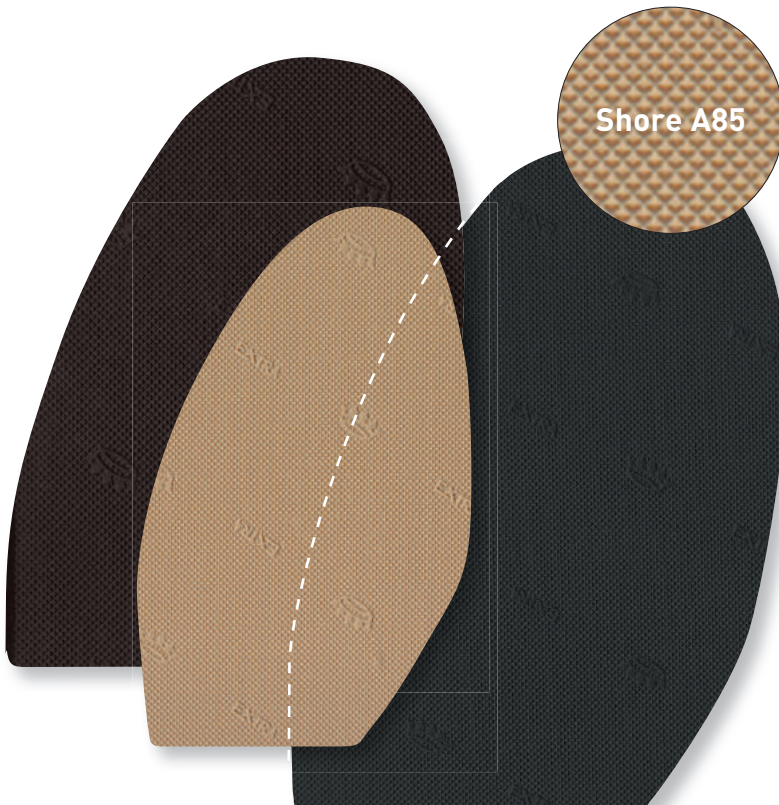

0 > 6

in 8 Größe DO bis H6
all 8 sizes DO to H6
alle 8 maten DO tot H6
les 8 pointures DO jusqu' à H6



0	1	4
schwarz black zwart noir	braun brown bruin brun	beige beige beige beige



18

1,8 mm



25

2,5 mm



30

3,0 mm



35

3,5 mm



40

4,0 mm



50

5,0 mm



(1/2) SOHLEN
 (1/2) SOLES
 (1/2) ZOLEN
 (1/2) SEMELLES

CREPINA SOFT 1508.

Vielfalt von 2 Platten (links/rechts) pro Größe
 Produced per 2 sheets (left/right) per size
 Veelvoud van 2 platen (links/rechts) per maat
 Production par 2 plaques (gauche/droite) par taille

Laufsohlen mit Krepp-Profil; sehr abriebfest
 Rubber sole, soft, profile crêpe; very good abrasion resistance
 Loopzolen in zacht rubber, met crêpe-profiel; zeer goede slijtvastheid
 Semelles en caoutchouc souple, avec profil crêpe; très bonne résistance à l'abrasion



□ > 6 > part 11.01

in 8 Größe DO bis H6
 all 8 sizes DO to H6
 alle 8 maten DO tot H6
 les 8 pointures DO jusqu' à H6

> page 2.8

□	1
in 16 Farben all 16 colours alle 16 kleuren toutes les 16 clrs	schwarz black zwart noir
	braun brown bruin brun

20	2 mm	•		
30	3 mm		•	•
40	4 mm	•		
50	5 mm		•	•
60	6 mm	•		

E	F
Länge 31cm length 31cm lengte 31cm longueur 31cm	Länge 35cm length 35cm lengte 35cm longueur 35cm

> page 2.8

16 Farben/colours/
kleuren/ couleurs

20	2 mm	•
40	4 mm	•
60	6 mm	•

FEATHER 152.7180.

91 x 58 cm

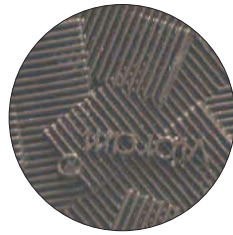
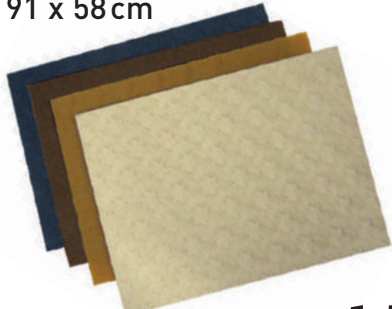

		40
		4mm
□	■	●
1	■	●

MANDORLO 152.8316.

126 x 70 cm

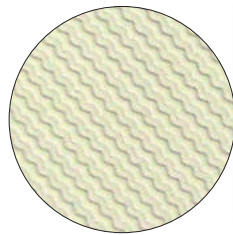
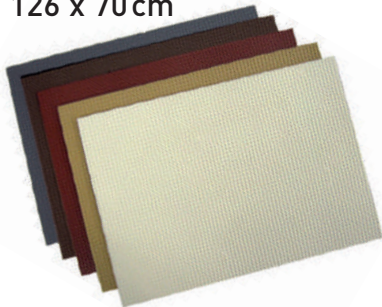

		050	060	080	100
		5mm	6mm	8mm	10mm
□	■	●	●	●	●
1	■	●	●	●	●

CLIVIA 152.8350.

126 x 70 cm

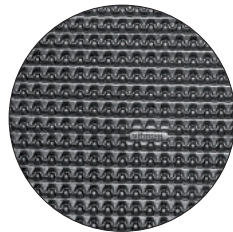
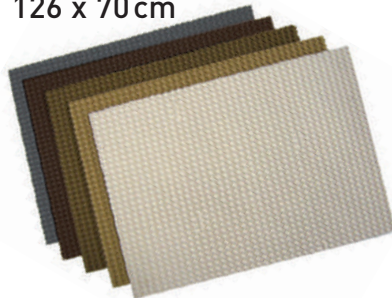

		60	80
		6mm	8mm
□	■	●	●
1	■	●	●

TEQUILGEMMA 152.7673.

112 x 85 cm

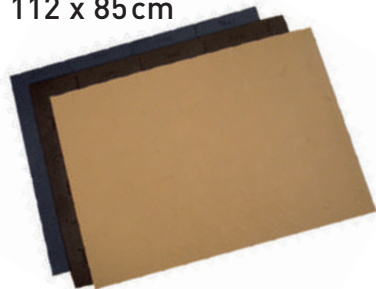

		18
		1,8mm
□	■	●
1	■	●

GRIP 152.75.

93 x 64 cm

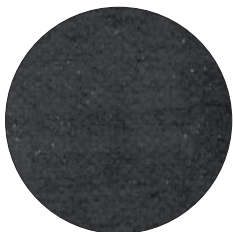
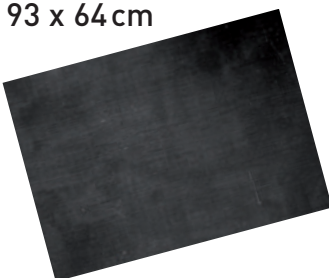

		20	40
		2mm	4mm
100	■	●	
090	■		●

schwarz
 black
 zwart
 noir

braun
 brown
 bruin
 brun





beige
 beige
 beige
 beige

weiß
 white
 wit
 blanc

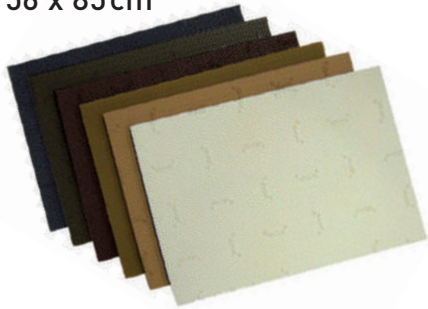
DUPLA 152.7179.

56 x 85 cm





		↓ 5	
		050 5mm	060 6mm
0		●	●
1		●	●
4		●	●
6			●
75	 capuccino		●

CILIEGIO MORFLEX 152.8365.

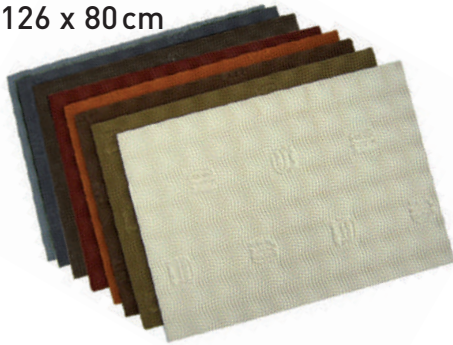
126 x 80 cm





		↓ 5	
		060 6mm	080 8mm
0		●	●
1		●	●
6		●	

NEWFLEX 152.8860.

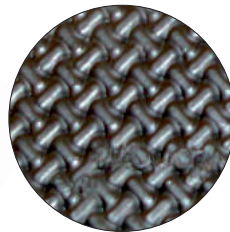
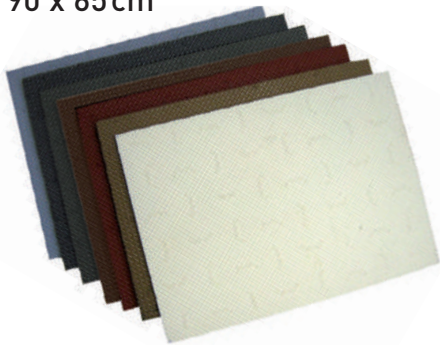
90 x 65 cm





		↓ 5			
		040 4mm	060 6mm	080 8mm	100 10mm
0		●	●	●	●
1			●	●	●

SUPER NEWFLEX 152.8868.

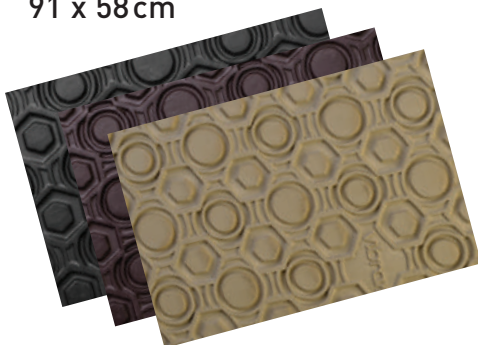
91 x 58 cm









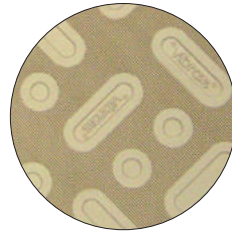
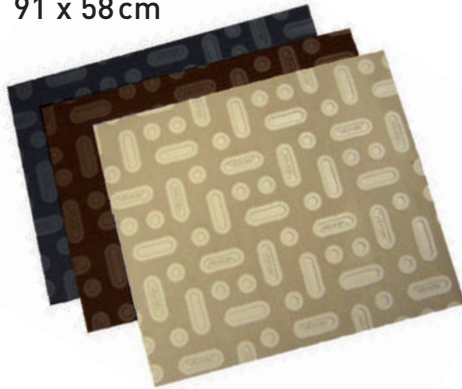

		↓ 5	
		40 4mm	60 6mm
0		●	●
1		●	●
4		●	●

SIXTY 152.7149.  

91 x 58 cm









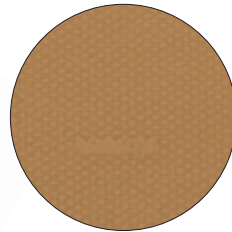
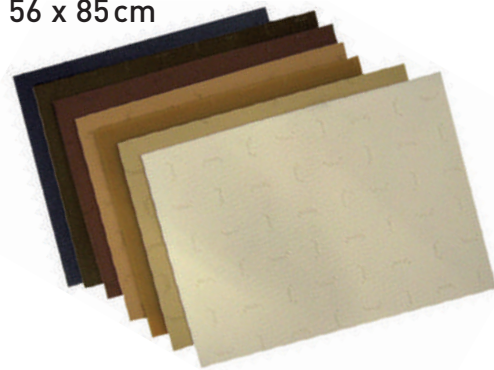

		30 3mm	
			
	1		
	4		

GEMMA 152.7163.  

56 x 85 cm









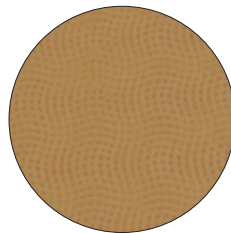
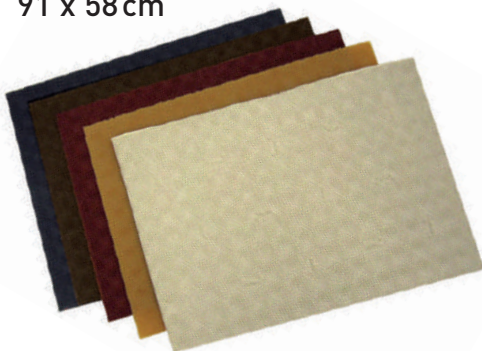



		30 3mm		40 4mm		60 6mm	
							
	1						
	7						

CHERRY 152.7175.  

91 x 58 cm









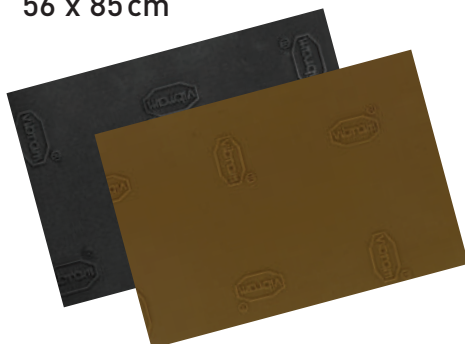

		40 4mm		60 6mm	
					
	1				
	4				

COMP NUVOLA 750P 152.750P.  

56 x 85 cm



		060 6mm	
			
	1		
	4		

2.07

1/1 SOHLEN
1/1 SOLES
1/1 ZOLEN
1/1 SEMELLES

VIBRAM

1p.

WINTER CITY 152.056C.



NEU
NEW
NIEUW
NOUVEAU

		38	40	42	44	46
		38	40	42	44	46
<input type="checkbox"/>		<input type="checkbox"/>	<input type="checkbox"/>	<input type="checkbox"/>	<input type="checkbox"/>	<input type="checkbox"/>

BREITHORN 152.1012.



		39	41	43	45	47
		39/40	41/42	43/44	45/46	47/48
<input type="checkbox"/>		<input type="checkbox"/>	<input type="checkbox"/>	<input type="checkbox"/>	<input type="checkbox"/>	<input type="checkbox"/>

TETON 152.1014.



		37	39	41	43	45
		37/38	39/40	41/42	43/44	45/46
<input type="checkbox"/>		<input type="checkbox"/>	<input type="checkbox"/>	<input type="checkbox"/>	<input type="checkbox"/>	<input type="checkbox"/>

IZALCO 152.1030.

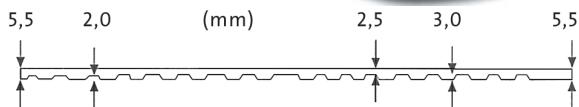

		36	38	40	42	44	46
		36/37	38/39	40/41	42/43	44/45	46/47
<input type="checkbox"/>		<input type="checkbox"/>	<input type="checkbox"/>	<input type="checkbox"/>	<input type="checkbox"/>	<input type="checkbox"/>	<input type="checkbox"/>
1		<input type="checkbox"/>	<input type="checkbox"/>	<input type="checkbox"/>	<input type="checkbox"/>	<input type="checkbox"/>	<input type="checkbox"/>

ROCCIA UOMO 152.1105/s.

Grip

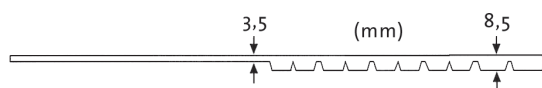

		35	37	39	41	43	45	47
		35/36	37/38	39/40	41/42	43/44	45/46	47/48
<input type="checkbox"/>		<input type="checkbox"/>	<input type="checkbox"/>	<input type="checkbox"/>	<input type="checkbox"/>	<input type="checkbox"/>	<input type="checkbox"/>	<input type="checkbox"/>



> page 2.29

AFT®

Advanced Foot Technology

2.07

1/1 SOHLEN
1/1 SOLES
1/1 ZOLEN
1/1 SEMELLES

MONTAGNA BLOCK 152.1132.

Grip

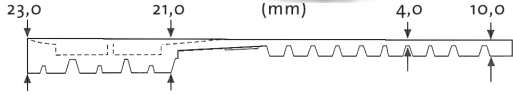

		35	37	39	41	43	45	47	49	51
		35/36	37/38	39/40	41/42	43/44	45/46	47/48	49/50	51/52
<input type="checkbox"/>		•	•	•	•	•	•	•	•	•
1		•	•	•	•	•	•	•	•	•

MONTAGNA BLOCK 152.1133.

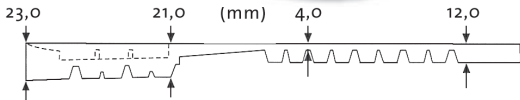

		33	35	37	39	41	43	45	47
		33/34	35/36	37/38	39/40	41/42	43/44	45/46	47/48
<input type="checkbox"/>		•	•	•	•	•	•	•	•

ROCCIA BLOCK 152.1136.

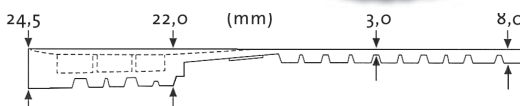

		35	37	39	41	43	45	47	49
		35/36	37/38	39/40	41/42	43/44	45/46	47/48	49/50
4		•	•	•	•	•	•	•	•

MONTAGNA BL.29 152.1149.

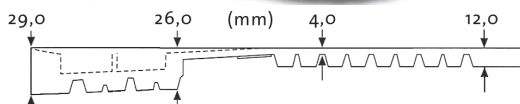

		35	37	39	41	43	45	47	49
		35/36	37/38	39/40	41/42	43/44	45/46	47/48	49/50
<input type="checkbox"/>		•	•	•	•	•	•	•	•

JANKUAT 152.1220.

Grip

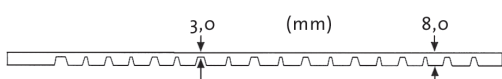

		35	37	39	41	43	45	47
		35/36	37/38	39/40	41/42	43/44	45/46	47/48
<input type="checkbox"/>		•	•	•	•	•	•	•
1		•	•	•	•	•	•	•

schwarz
black
zwart
noir

braun
brown
bruin
brun

beige
beige
beige
beige

weiß
white
wit
blanc

VIBRAM

1p.

SASS MAOR 152.1230.



	41	43	45
	41/42	43/44	45/46
<input type="checkbox"/>	<input type="checkbox"/>	<input type="checkbox"/>	<input type="checkbox"/>

USHBA 152.1485.



NEU
NEW
NIEU
NOUVEAU

	38 > 46	47
	38 > 46	47,5
<input type="checkbox"/>	<input type="checkbox"/>	<input type="checkbox"/>

MOMBELLO 152.1685.



	078	091	113
	41/42	43/45	46/48
<input type="checkbox"/>	<input type="checkbox"/>	<input type="checkbox"/>	<input type="checkbox"/>

CAMBRIDGE 152.2002.

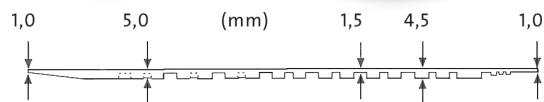

	030	050	070	090	110	130
	35/37	38/40	41/42	43/44	45/46	47/48
<input type="checkbox"/>	<input type="checkbox"/>	<input type="checkbox"/>	<input type="checkbox"/>	<input type="checkbox"/>	<input type="checkbox"/>	<input type="checkbox"/>
6	<input type="checkbox"/>	<input type="checkbox"/>	<input type="checkbox"/>	<input type="checkbox"/>	<input type="checkbox"/>	<input type="checkbox"/>

ETON 152.2055S.



	05	07	09	11	13
	38/40	41/42	43/44	45/46	47/48
<input type="checkbox"/>	<input type="checkbox"/>	<input type="checkbox"/>	<input type="checkbox"/>	<input type="checkbox"/>	<input type="checkbox"/>
1	<input type="checkbox"/>	<input type="checkbox"/>	<input type="checkbox"/>	<input type="checkbox"/>	<input type="checkbox"/>

> page 2.29

2.07

1/1 SOHLEN
1/1 SOLES
1/1 ZOLEN
1/1 SEMELLES

LIENZ 152.2094.



	05	07	09	11
	38/40	41/42	43/44	45/46
□	●	●	●	●
1	●	●	●	●

LIVERPOOL 152.2600.

gumlite®

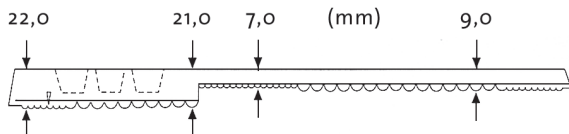

	35	37	39	41	43	45	47
	35/36	37/38	39/40	41/42	43/44	45/46	47/49
□	●	●	●	●	●	●	●
1	●	●	●	●	●	●	●

ATHENA 152.2609.

gumlite®



	□	
		unysize 39/46
□	●	
1	●	
4	●	

ODESSA 152.2640.

gumlite®

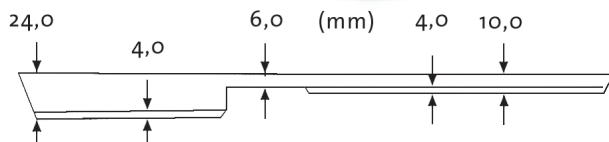



	37	39	41	43	45
	37/38	39/40	41/42	43/44	45/46
□	●	●	●	●	●
1	●	●	●	●	●

DURBAN 152.2644.

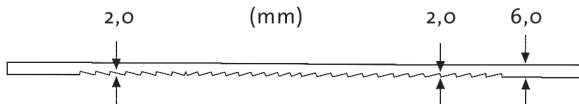
gumlite®





		35	37	39	41	43	45
		35/36	37/38	39/40	41/42	43/44	45/46
<input type="checkbox"/>		●	●	●	●	●	●
1		●	●	●	●	●	●

LIPSIA 152.2653.

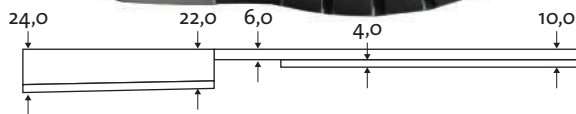
gumlite®





		41	45
		41/44	45/47
<input type="checkbox"/>		●	●
1		●	●

SPRINGS 152.2655/S.

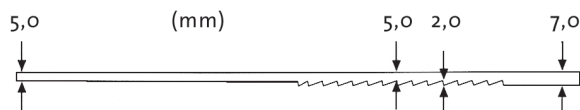
gumlite®





		35	37	39	41	43	45	47
		35/36	37/38	39/40	41/42	43/44	45/46	47/48
<input type="checkbox"/>		●	●	●	●	●	●	●
1		●	●	●	●	●	●	●

FUNKY ORTHO 152.2667.

gumlite®



		41	45
		41/44	45/47
<input type="checkbox"/>		●	●
1		●	●

2.07

1/1 SOHLEN
1/1 SOLES
1/1 ZOLEN
1/1 SEMELLES









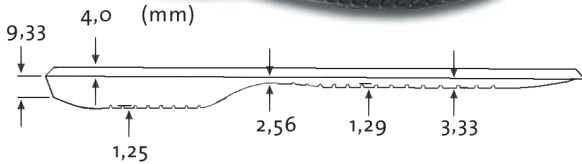















VIBRAM

 1p.

HEIDELBERG 152.2668.  

gumlite®

















		37	39	41	43	45	47
		37/38	39/40	41/42	43/44	45/46	47/48
							
							
							

MINSK 152.2678.  











Grip



		37	39	41	43	45
		37/38	39/40	41/42	43/44	45/46
						
						









AQUAGUM DONNA 152.2690.  



		35	39	43
		35/38	39/42	43/46
				
				

AQUAGUM UOMO 152.2691.  



		39	43
		39/42	43/46
			
			

2.08

1/2 SOHLEN
1/2 SOLES
1/2 ZOLEN
1/2 SEMELLES

VIBRAM

1p.

SIMON 152.2027.



		39	43	47
		39/42	43/46	47/50
□		●	●	●
1		●	●	●

MORTARA 152.2333.

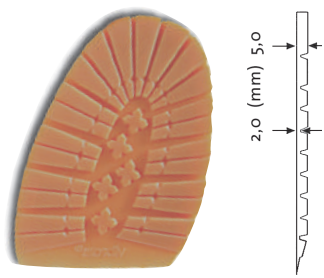

		41	43	45	47
		41/42	43/44	45/46	47/50
□		●	●	●	●
1		●	●	●	●
4		●	●	●	●
7		●	●	●	●

ANGERA 152.2336.



		35	38	41	44	47
		35/37	38/40	41/43	44/46	47/50
□		●	●	●	●	●
1		●	●	●	●	●
4		●	●	●	●	●

STRESA 152.2337.



		39	43	47	49
		39/42	43/46	47/48	49/52
□		●	●	●	●
1		●	●	●	●

SIMONA 152.3928.



		34	37	40
		34/36	37/39	40/42
□		●	●	●
1		●	●	●

schwarz
black
zwart
noir

braun
brown
bruin
brun

beige
beige
beige
beige

karamell
toffee
karamel
caramel



GRIZZLY 152.2024.

1/2 SOHLE - 1/2 SOLE - 1/2 ZOOL - 1/2 SEMELLE



ARIEL 152.2342.

1/2 SOHLE - 1/2 SOLE - 1/2 ZOOL - 1/2 SEMELLE



GRIZZLY 152.5424.

FORMABSATZ - MOULDED HEEL - GEVORMDE HAK - TALON MOULÉ



	01	03
	nr1	nr3
□	■	●
1	■	●

ARIEL 152.5342.

FORMABSATZ - MOULDED HEEL - GEVORMDE HAK - TALON MOULÉ



	00	01	03
	00	01	03
□	■	●	●
1	■	●	●
4	■	●	●
6	□	●	●

LONG HAUL 152.0516.

10



KS
Profillangsohle
Profile long sole
Profielzool
Semelle profilée

KT
Formabsatz
moulded heel
gevormde hak
talon moulé

**NEU
NEW
NIEU
NOUVEAU**

	06	09	12	14
	37/38	43/44	47/48	50/55
□	■	●	●	●
1	■	●	●	●

ROCCIA 152.1105/T.



Grip

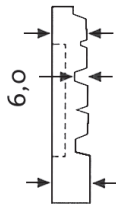

> page 2.21



	33	36	39	41	43	45
	33/35	36/38	39/40	41/42	43/44	45/47

<input type="checkbox"/>		<input type="checkbox"/>	<input type="checkbox"/>	<input type="checkbox"/>	<input type="checkbox"/>	<input type="checkbox"/>
--------------------------	--	--------------------------	--------------------------	--------------------------	--------------------------	--------------------------

ROCCIA 152.1205.

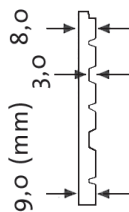

	39	41	43	45	48
	39/40	41/42	43/44	45/47	48/50

<input type="checkbox"/>		<input type="checkbox"/>	<input type="checkbox"/>	<input type="checkbox"/>	<input type="checkbox"/>
1		<input type="checkbox"/>	<input type="checkbox"/>	<input type="checkbox"/>	<input type="checkbox"/>
4		<input type="checkbox"/>	<input type="checkbox"/>	<input type="checkbox"/>	<input type="checkbox"/>
7		<input type="checkbox"/>	<input type="checkbox"/>	<input type="checkbox"/>	<input type="checkbox"/>

ETON 152.2055T.



> page 2.23



	05	07	09	11	13
	05/06	07/08	09/10	11/12	13/14

<input type="checkbox"/>		<input type="checkbox"/>	<input type="checkbox"/>	<input type="checkbox"/>	<input type="checkbox"/>
1		<input type="checkbox"/>	<input type="checkbox"/>	<input type="checkbox"/>	<input type="checkbox"/>

SPRINGS 152.2655/T.



gumlite®

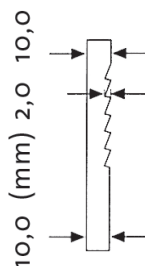

	35	37	39	41	43	45
	35/36	37/38	39/40	41/42	43/44	45/46

<input type="checkbox"/>		<input type="checkbox"/>	<input type="checkbox"/>	<input type="checkbox"/>	<input type="checkbox"/>	<input type="checkbox"/>
1		<input type="checkbox"/>	<input type="checkbox"/>	<input type="checkbox"/>	<input type="checkbox"/>	<input type="checkbox"/>

EXPLOSION 152.5340.



1p.



		20	40
		020	040
□		●	●
1		●	●

TOP 152.5350.



1p.



		M00	M01	M02	M03	M04
		M00	M01	M02	M03	M04
□		●	●	●	●	●
1		●	●	●	●	●
4		●	●			

MARTA 152.5721.



1p.



		M01	M02	M03	M04
		M01	M02	M03	M04
□		●	●	●	●
1		●	●	●	●
4		●	●	●	●

2.10

PROFILLANGSOHLEN
 PROFILE LONG SOLES
 PROFIELZOLEN
 SEMELLES PROFILÉES

YETI 1530.



orthopädic
 orthopaedic
 orthopédisch
 orthopédique

UNISIZE		
	0	1
	schwarz black zwart noir	braun brown bruin brun
1	•	•
2	•	•

B-TECH 1540.



	00	01	03	04	05	07	09
	•	•	transp.	•	•	•	•
02 35cm	•	•	•	•	•	•	•

SCOOTER 1541.



	36	39	42	45	48
	36/38	39/41	42/44	45/47	48/50
00	•	•	•	•	•
03 transp.	•	•	•	•	•

URBAN 1542.



	02	03
	31,5cm	35,5cm
00	•	•
03 transp.	•	•

**FRÄSTECHNIK, EINLAGEN-ROHLINGE
MILLING TECHNIQUES, ORTHOPEDIC FOOT SUPPORTS
FREESTECHNIEK, STEUNZOLEN
TECHNIQUE À FRAISER, SEMELLES ORTHOPÉDIQUES**

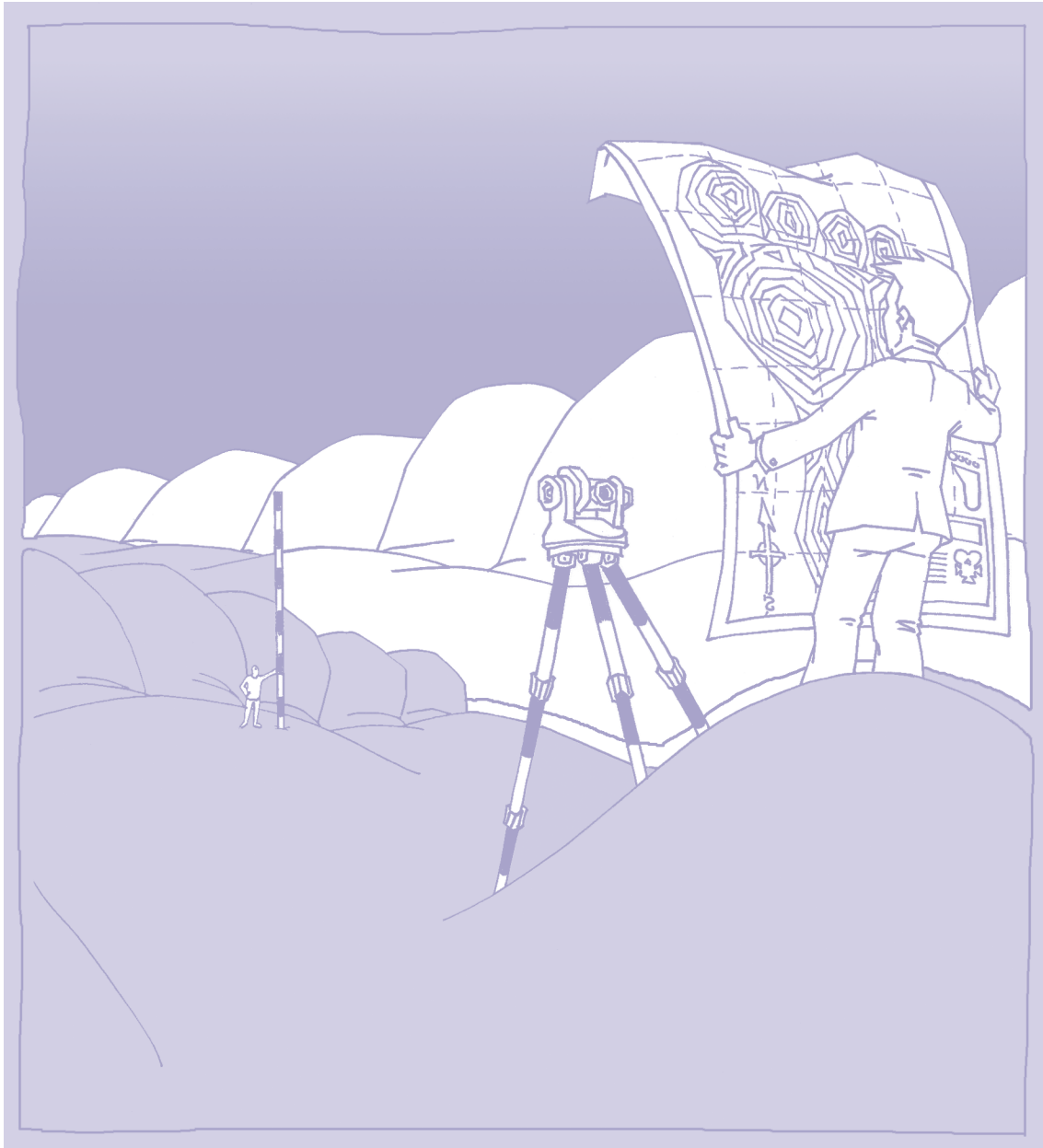

AFT[®]

AFT-International.com



3.01	FRÄSTECHNIK MILLING TECHNIQUES FREESTECHNIEK TECHNIQUE À FRAISER	3.2
3.02	D3D-CONCEPT DYNAMIC 3-DIMENSIONAL CONCEPT	3.16
3.03	EIGENE PRODUKTION OUR OWN PRODUCTION EIGEN FABRIKAAT PROPRE FABRICATION SPORT	3.24 3.28 3.30
3.04	PELOTTEN - STÜTZEN - FERSENKISSEN PADS - SUPPORTS - HEELCUSHIONS PELOTTEN - INBOUWDELEN - HIELKUSSENS PELOTTES - SUPPORTS - TALONETTES	3.32
3.05	BIRKO SCHALENFORMEN BIRKO SHELL FORMS BIRKO SCHAALVORMEN BIRKO FORMES DE COQUILLE	3.44

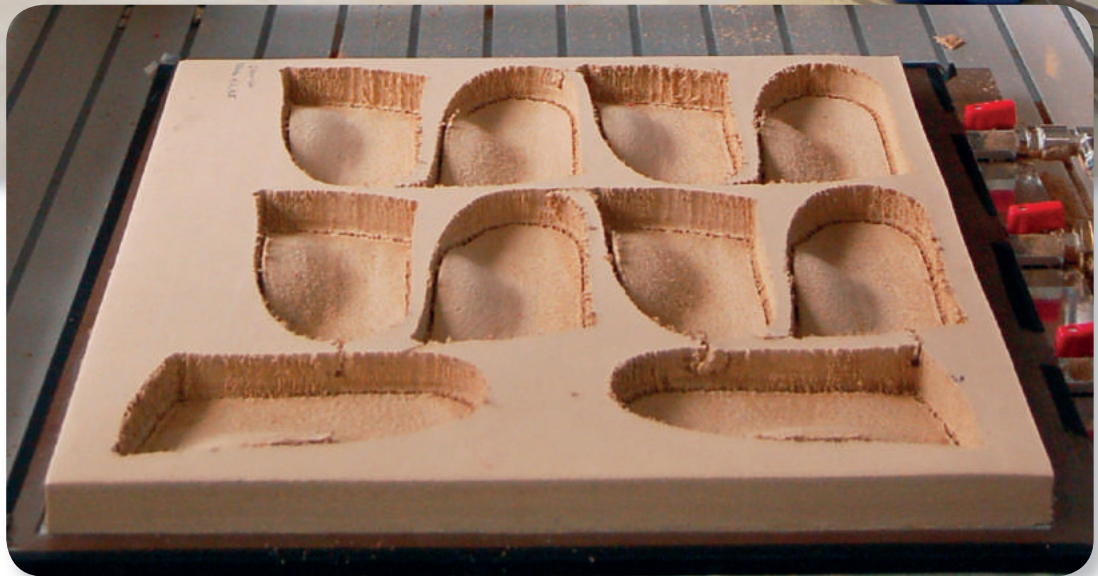

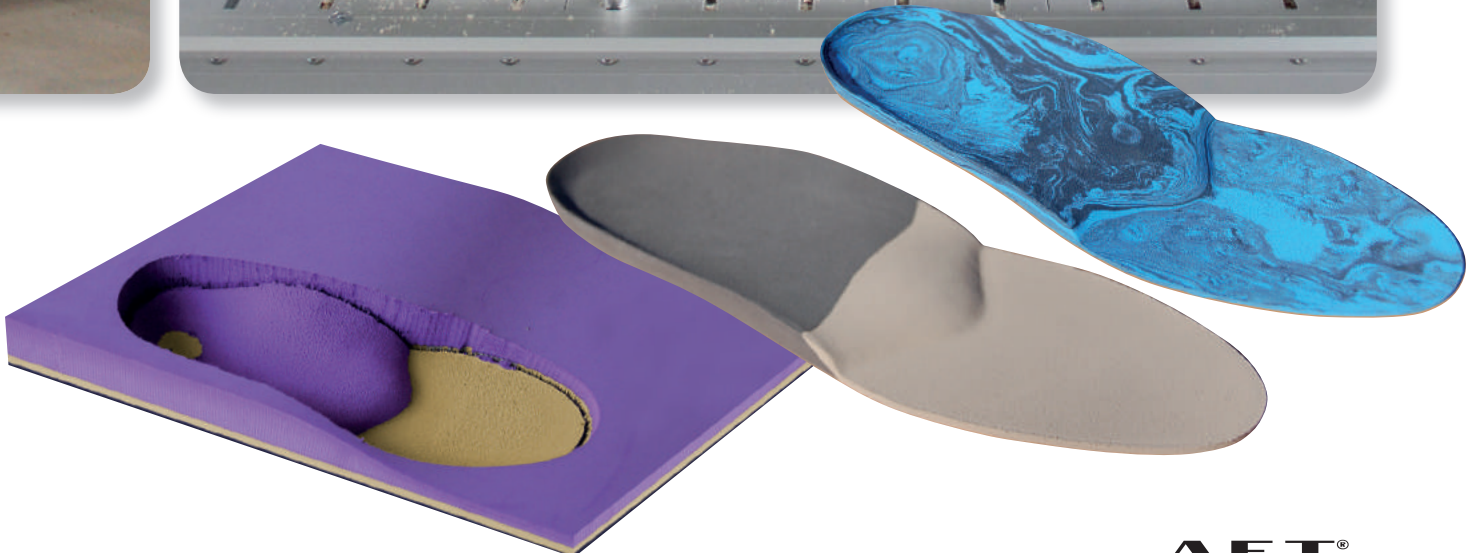
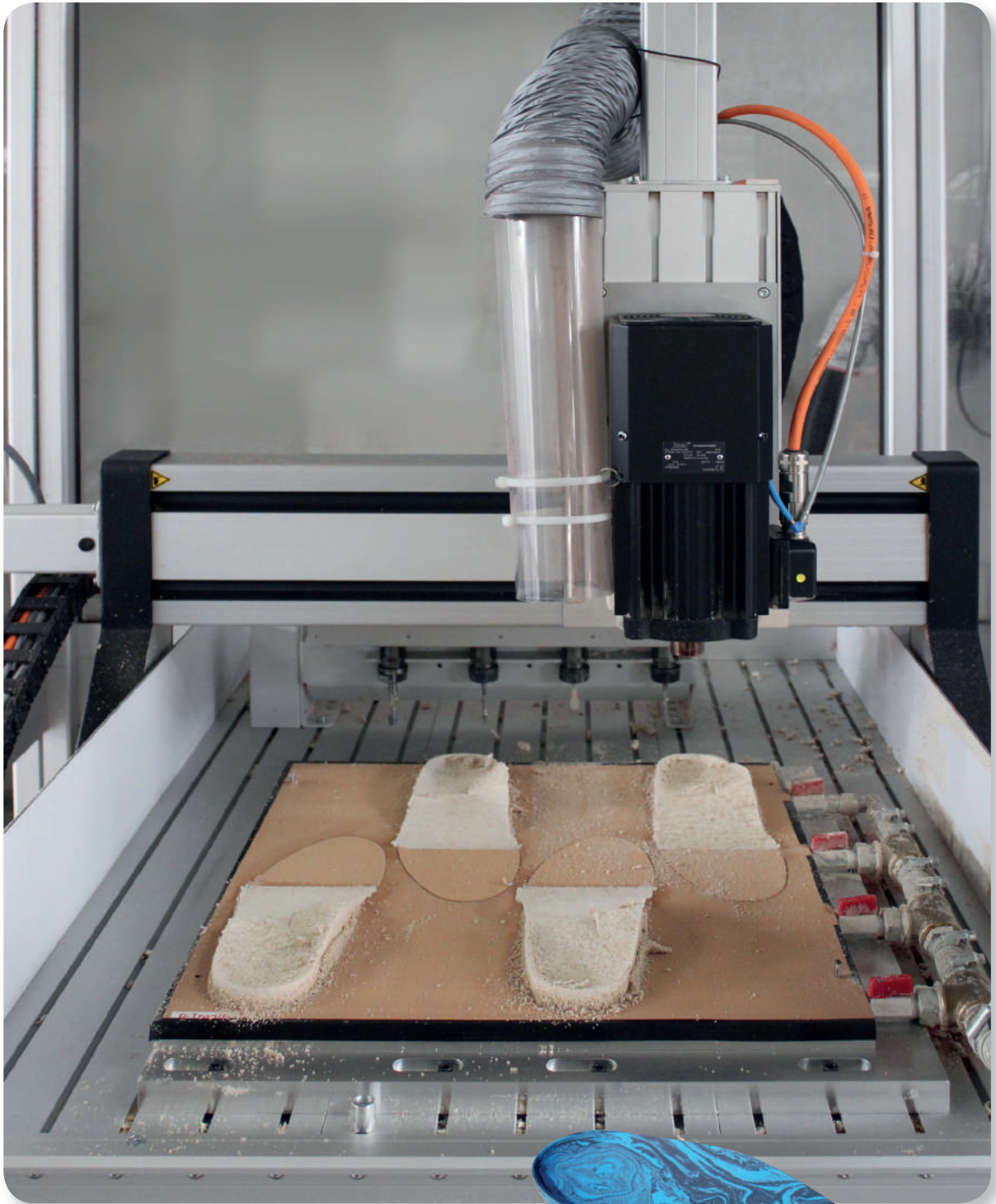

KEILE
STRIPES
STROKEN
BANDES

UNI-FORM

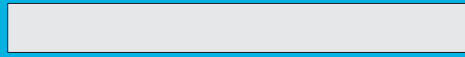

shore	15mm	20mm	25mm	30mm	35mm	40mm
	20>60	20>60	20>60	20> 70	20>60	20>60

> part 1

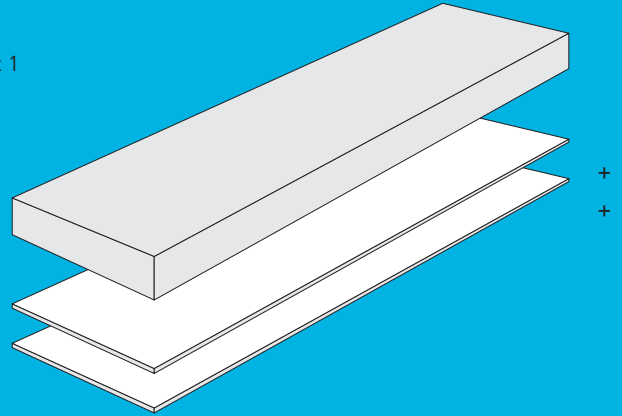

ORTHO-FORM



30>60	30mm	5/25	
60	35mm	8/27	
30> 50	40mm	10/30	

> page 3.6

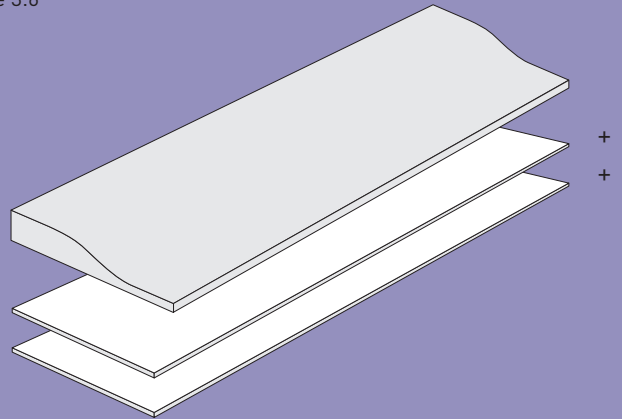

COMBI-FORM



25mm	30mm
------	------

> page 3.10

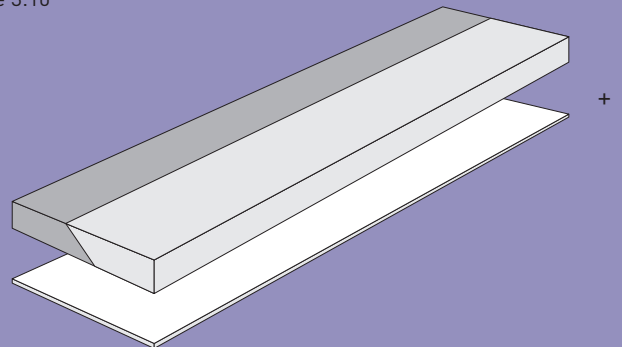

SPECIALS ('BROODJES')

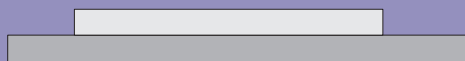

> page 3.12

+ EXTRA COMFORT/STIFFENING/BOTTOM SOLE

> page 3.7

BLOCK
BLOCK
BLOK
BLOC

1/2 BLOCK
1/2 BLOCK
1/2 BLOK
1/2 BLOC

FRÄSROHLINGE
MILLING SOLES
FREESZOLEN
SEM. A FRAISER

END PRODUKT
END PRODUCT
EIND PRODUCT
PRODUIT FINAL

 > page 3.13

STANDARD*: 35 x 25 cm

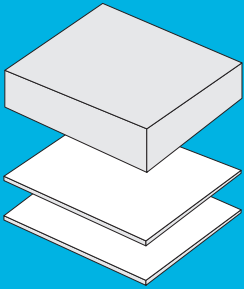

STANDARD*: 31 x 12,5 cm
35 x 13 cm

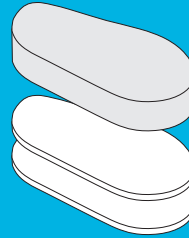
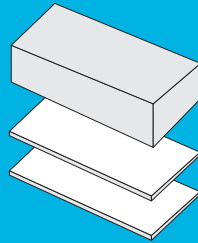

STANDARD*: 35 x 25 cm

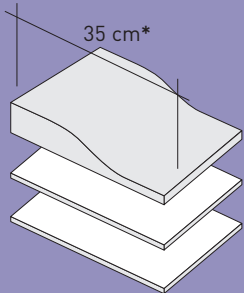

STANDARD*: 31 x 12,5 cm
35 x 13 cm

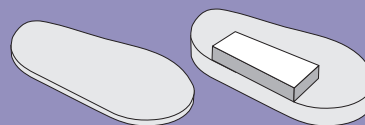
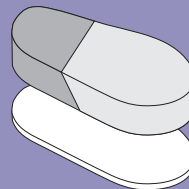
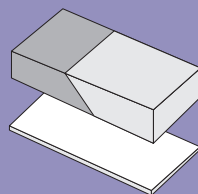
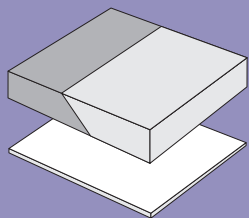
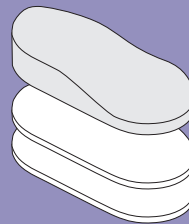
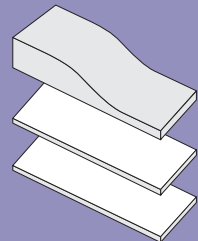

* andere Abmessungen sind möglich
other dimensions are possible
andere afmetingen zijn mogelijk
autres dimensions sont possibles

ORTHO-FORM

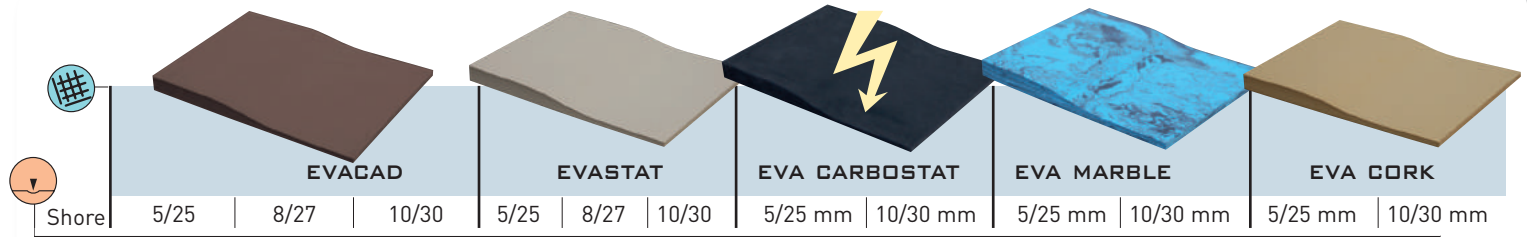

Shore	EVAGAD			EVA STAT			EVA CARBOSTAT		EVA MARBLE		EVA CORK	
	5/25	8/27	10/30	5/25	8/27	10/30	5/25 mm	10/30 mm	5/25 mm	10/30 mm	5/25 mm	10/30 mm
25	09		87 09									
30	87 98 72		87 98 78 09 76 81	09	09	09		81				
35	09	15	78 81 09			81						
40	21 81 01 09 78 65	21 15	21 81 15 09 78 76 65		89	89		81		38 32 45 48 41		
45	28 71	09 46 28 81	46 28 71	09 81 87		09 81 87						
50	28 46 81 78	28 81	28 21 81 78 01 14 06			87 78		81		38 32 45		
55												
60	81 78 46 85	29 78 85 76		09 81 87								

shore	ELASTOFLEX		HIGHFLEX	
	5/25 mm	10/30 mm	5/25 mm	10/30 mm
15	101 176	101 176		
20	174	174		
25			172	172

shore	EXTRAFOAM (Extrafoam, Multicolour, Aqua, Marble)	SUPERSOFT SOFTAIR TERMOLAST
	25 bis to t/m à 60	5/25 mm

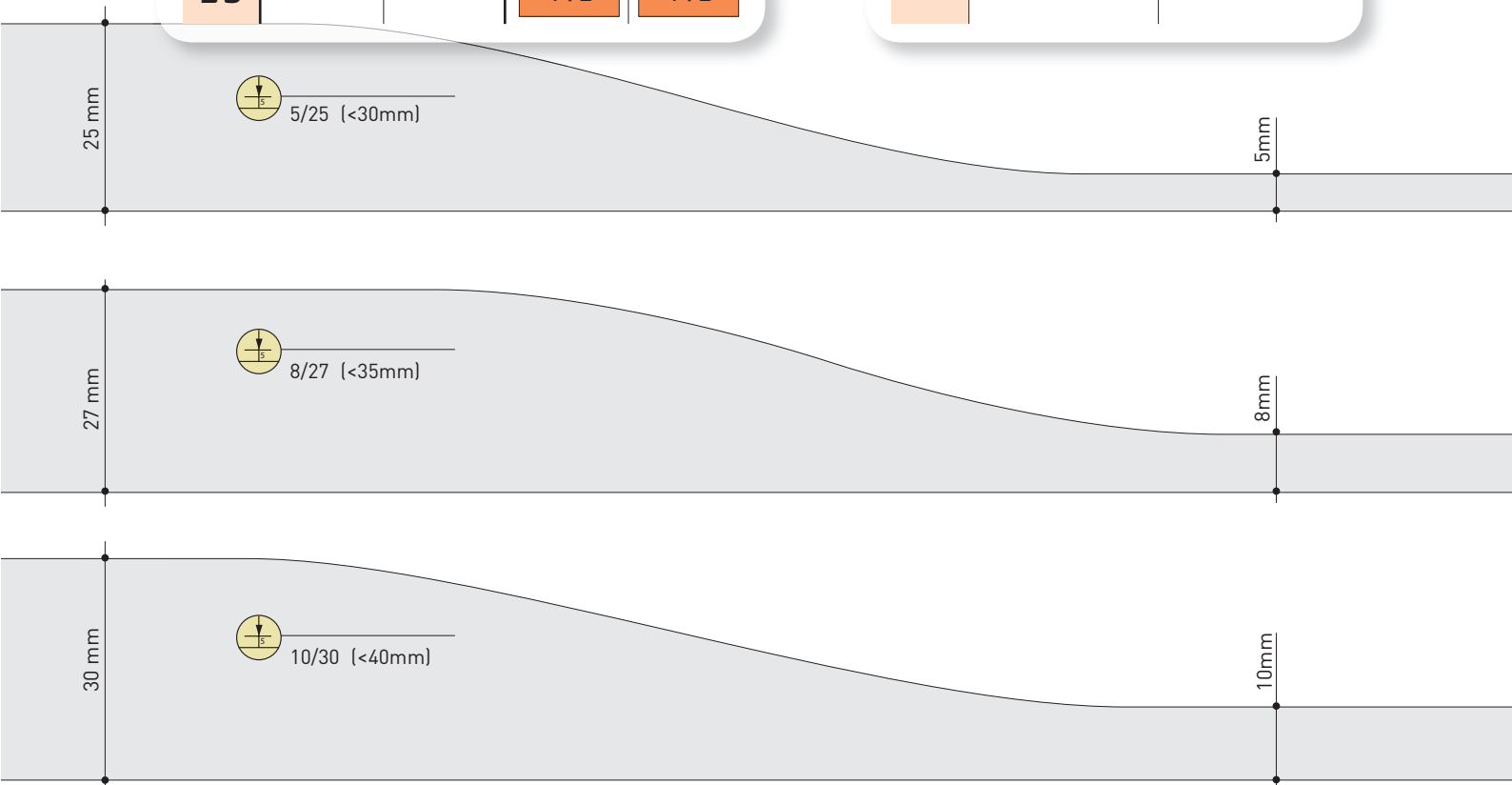

EXTRA COMFORT/STIFFENING

Wählen Sie falls erwünscht eine zweite Schicht für extra Komfort oder Verstärkung
 Choose if desired a second layer for extra comfort or strengthening
 Kies indien gewenst een tweede laag voor extra comfort of versteviging
 Choisissez si désiré une deuxième couche pour plus de confort ou renforcement



BRANDSOHL - BOTTOM SOLE - GROND PATROON - PREMIÈRE

Wählen Sie falls erwünscht ein Brandsohlenmaterial
 Choose if desired a bottom sole material
 Kies indien gewenst een materiaal voor grondpatronen
 Choisissez si désiré un matériel pour premières



DURALUX beige DURALUX black DURALITE beige	EVACAD Shore70 HARDAIR Shore60
1,2mm	2mm

ORTHO-FORM

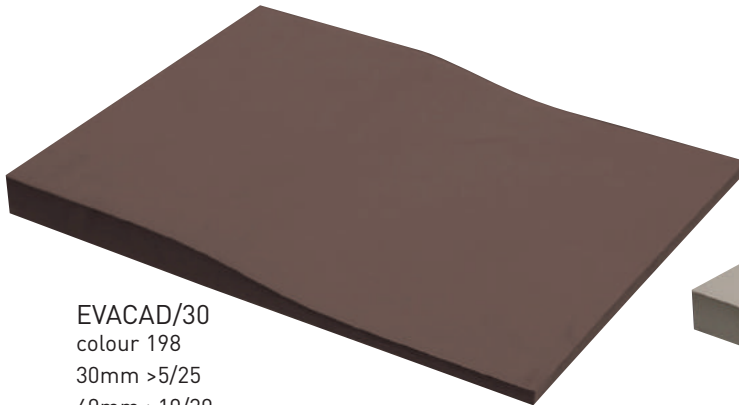

EVACAD/30
colour 198
30mm >5/25
40mm >10/30

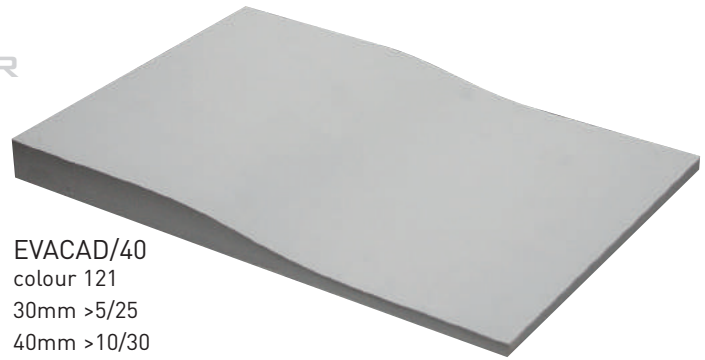

EVACAD/40
colour 121
30mm >5/25
40mm >10/30

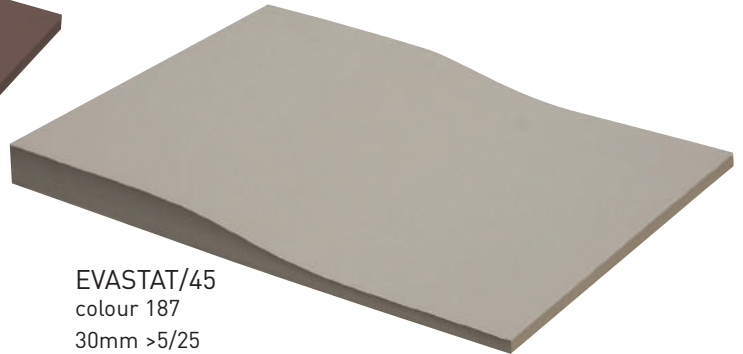

EVASTAT/45
colour 187
30mm >5/25
40mm >10/30



EVASTAT/30
colour 109
30mm >5/25
40mm >10/30

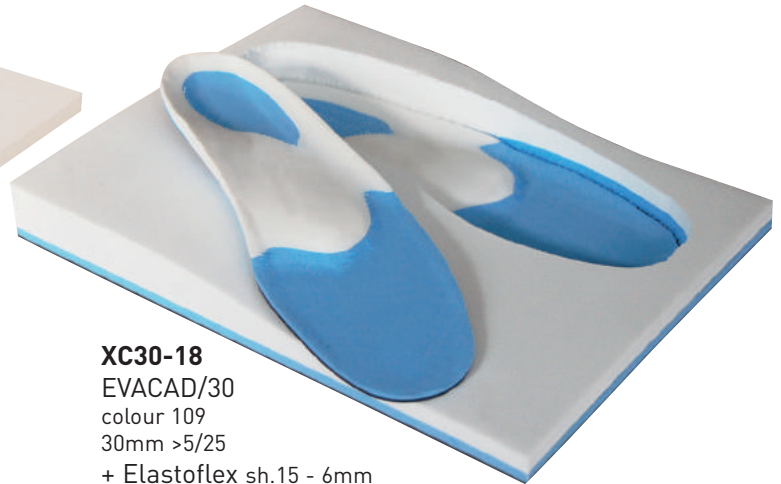

XC30-18
EVACAD/30
colour 109
30mm >5/25
+ Elastoflex sh.15 - 6mm
+ Evacad/70 - 2mm

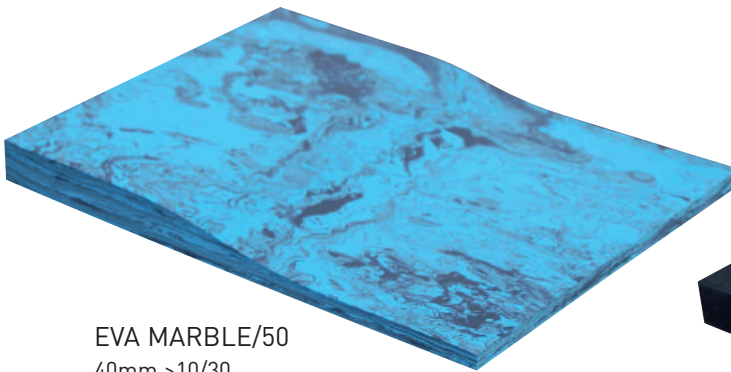

EVA MARBLE/50
40mm >10/30



EVA CARBOSTAT/30/40/50
40mm >10/30



EVACAD, EVASTAT

109	114	115	187	189	121	128	129	181
weiß white wit blanc	elfenbein ivory ivoor ivoir	beige beige beige beige	tierra	arena	hellgrau light grey lichtgrijs gris clair	dunkelgrau dark grey donkergrijs gris foncé	anthrazit anthracite antraciet anthracite	schwarz black zwart noir

Beispiele - examples - voorbeelden - exemples

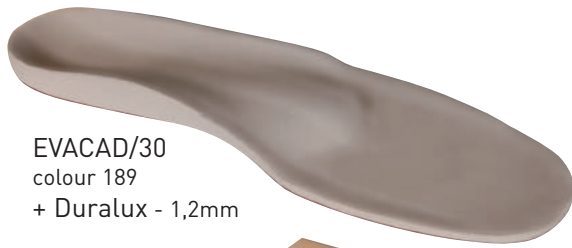

EVACAD/30
colour 189
+ Duralux - 1,2mm

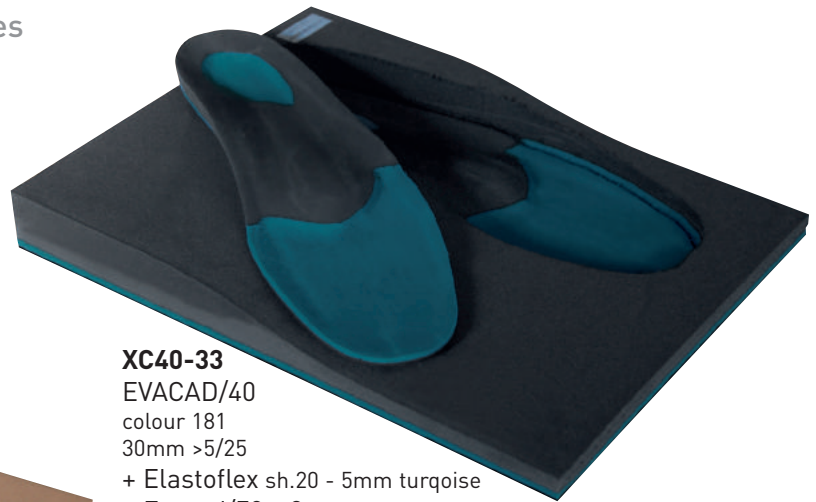

XC40-33
EVACAD/40
colour 181
30mm >5/25
+ Elastoflex sh.20 - 5mm turquoise
+ Evacad/70 - 2mm

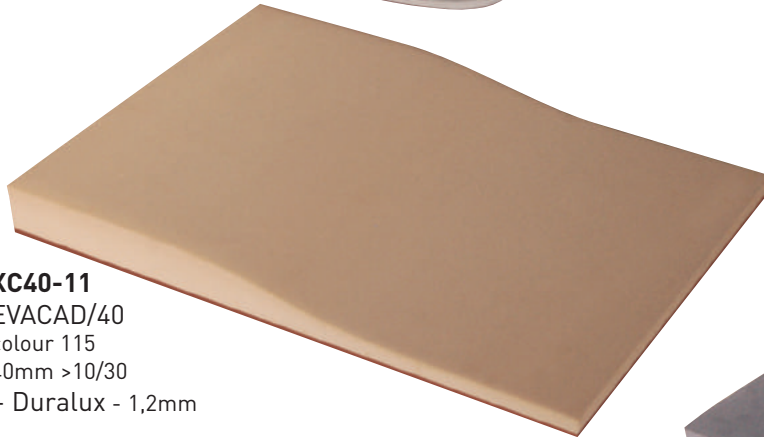

XC40-11
EVACAD/40
colour 115
40mm >10/30
+ Duralux - 1,2mm



XC50-23
EVACAD/50
colour 128
30mm >5/25
+ Highflex sh.25 - 4mm
+ Evacad/70 - 2mm

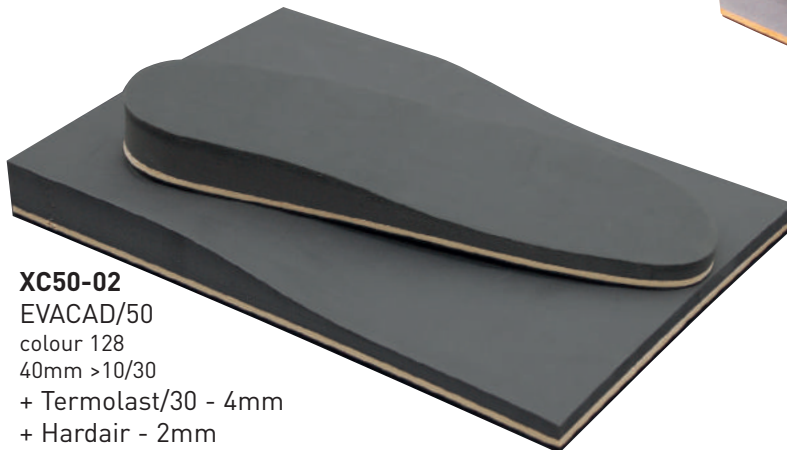

XC50-02
EVACAD/50
colour 128
40mm >10/30
+ Termolast/30 - 4mm
+ Hardair - 2mm

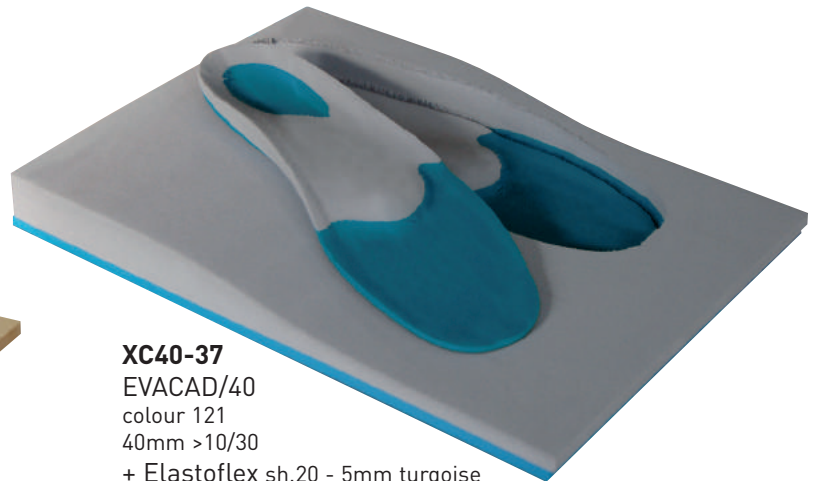

XC40-37
EVACAD/40
colour 121
40mm >10/30
+ Elastoflex sh.20 - 5mm turquoise
+ Evacad/70 - 2mm



EVA CORK/55
30mm >5/25
40mm >10/30

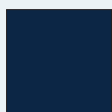
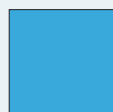
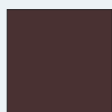
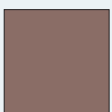
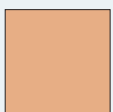

101

hautfarbe
skin
huidskleur
couleur chair

198

otter
otter
loutre
otter

146

dunkelbraun
dark brown
donkerbruin
brun foncé

171

pistache

176

hellblau
light blue
lichtblauw
bleu clair

178

dunkelblau
dark blue
donkerblauw
bleu foncé

106

rot
red
rood
rouge

172

orange
orange
oranje
orange

165

gelb
yellow
geel
jaune

COMBI-FORM

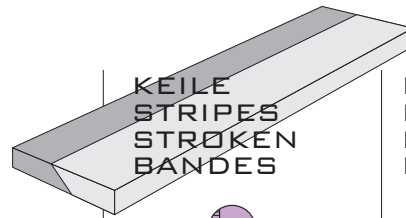

BLOCK
BLOCK
BLOK
BLOC

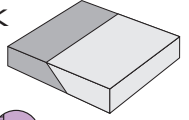

25 or 30mm



 50/50%	25 or 30mm				
	30mm	187 shore 30	121 shore 40	32 x 180cm 71CS-103-32	32 x 25cm 77CS-103-0020
	30mm	187 shore 30	121 shore 40	36 x 180cm 71CS-103-36	36 x 25cm 77CS-103-0063
	30mm	187 shore 30	128 shore 50	32 x 175cm 71CS-101-32	32 x 25cm 77CS-101-0020
	30mm	187 shore 30	128 shore 50	36 x 175cm 71CS-101-36	36 x 25cm 77CS-101-0063
	30mm	121 shore 35	125 shore 50	36 x 175cm 71CS-108-39	36 x 25cm 77CS-108-0063
	30mm	121 shore 40	128 shore 60	36 x 164cm 71CS-102-36	36 x 25cm 77CS-102-0063
	30mm	121 shore 40	128 shore 60	40 x 164cm 71CS-102-40	
 60/40%	25mm	109 shore 30	178 shore 50	31 x 175cm 71CY-501-31	31 x 25cm 77CY-501-0064
	25mm	109 shore 30	178 shore 50	36 x 175cm 71CY-501-36	36 x 25cm 77CY-501-0063
	25mm	109 shore 40	128 shore 60	31 x 164cm 71CY-502-31	31 x 25cm 77CY-502-0064
	25mm	109 shore 40	128 shore 60	36 x 164cm 71CY-502-36	36 x 25cm 77CY-502-0063
	25mm	114 shore 30	178 shore 40	31 x 185cm 71CY-507-31	
	30mm	176 (Elastoflex) shore 15	178 shore 35	33 x 190cm 71CY-505-33	33 x 25cm 77CY-505-0029
	30mm	187 shore 30	146 shore 50	36 x 175cm 71CY-503-36	36 x 1cm 77CY-503-0125
	30mm	198 shore 35	146 shore 55	33 x 168cm 71CY-506-33	33 x 25cm 77CY-506-0025
SPECIAL TRIVULCANIZED	38→10mm			35 x 160cm 71CV-450-135	33 x 25cm 77CV-450-129
		shore 45 - 30>2mm shore 25 - 6mm shore 55 - 2mm			

PDN GERADE
 PDN STRAIGHT
 PDN RECHT
 PDN DROIT

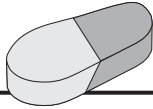

PDN DIAGONAL
 PDN DIAGONAL
 PDN DIAGONAAL
 PDN DIAGONAL

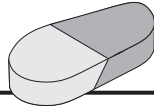

PDN2
77CS-101-00P2
 PDN3
77CS-101-00P3

32 x 25cm
77CS-101-02P2D
 36 x 25cm
77CS-101-02P3D

PDN2
77CY-501-00P2
 PDN3
77CY-501-00P3
 PDN2
77CY-502-00P2
 PDN3
77CY-502-00P3

31 x 25cm
77CY-501-02P2D
 36 x 25cm
77CY-501-02P3D

77CV-450-129
 TRIVULCANIZED

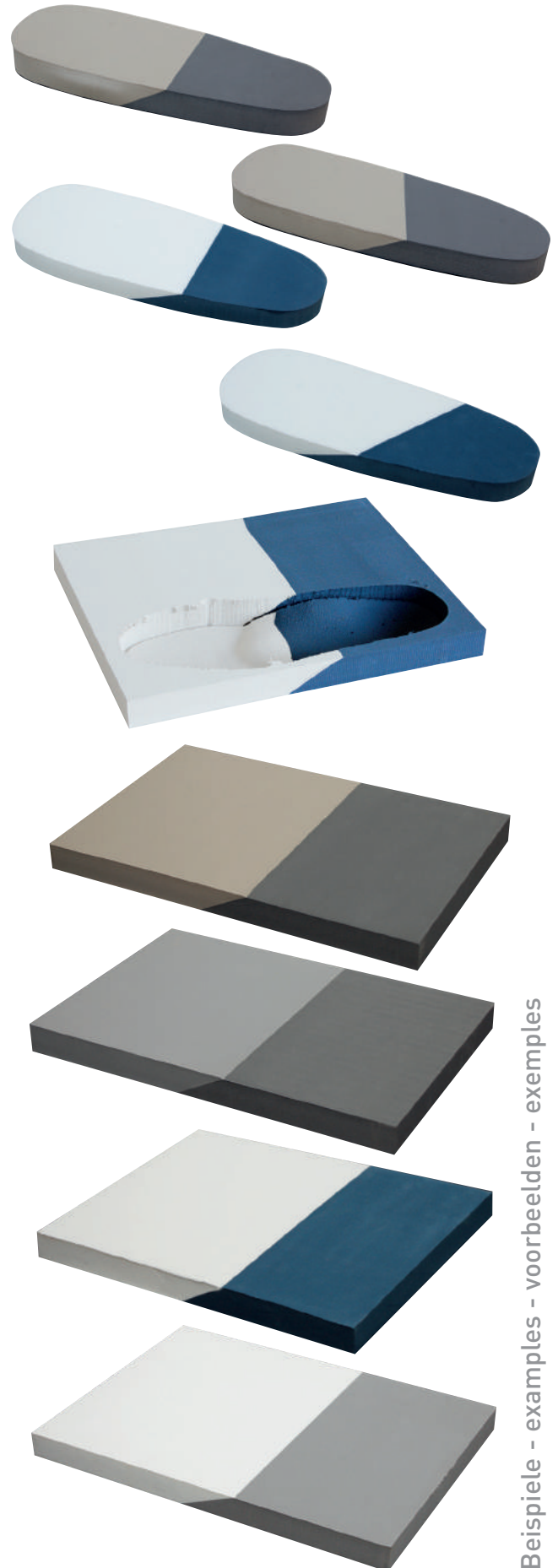
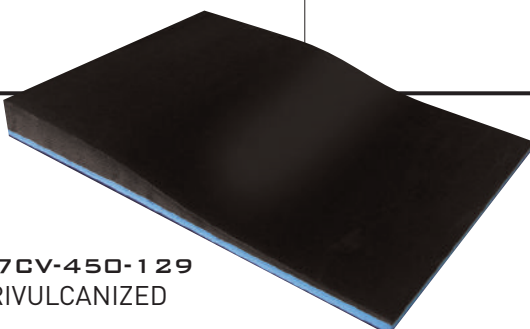

Beispiele - examples - voorbeelden - exemples

SPECIALS

Diese 'Fräsblöcke' bestehen aus 1 oder mehrere Materialien in der jeweiligen Shore-Härte Ihrer Wahl, verklebt mit Brandsohlenmaterial wie z.B. Duralux.

These 'millingblocks' consist of 1 or more layers in materials of various shore values of your choice, glued on a bottom sole in for example Duralux.

Dit zijn 'freesblokken' bestaande uit 1 of meerdere lagen in verschillende materialen met een shorewaarde naar keuze, verlijmd op een grondpatroon in bv. Duralux.

Ce sont des 'blocs à fraiser' en 1 ou plusieurs couches (matières au choix), collé sur une matériel pour première, comme par exemple Duralux.



Alle Materialien (Shore + Stärke + Farbe) nach Wahl
All material (Shore + thickness + colour) of your choice
Alle materialen (Shore + dikte + kleur) naar keuze
Tous les matériaux (Shore + épaisseur + couleur) à votre choix

MILLING SOLES

FRÄSROHLINGE
FREESZOLEN
SEM. A FRAISER



BIO		35 > 50
FINN		35 > 48
PDN		1 > 3



Beispiele - examples - voorbeelden - exemples



UNI-FORM
Evacad/40 - 40mm - colour 121
BIO



COMBI-FORM
Bloc 4630 - 30mm, BIO
+ Duralux - 1,2mm

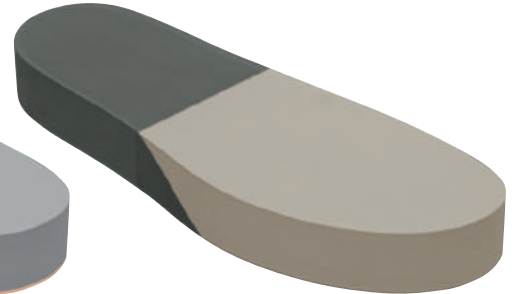

COMBI-FORM
Bloc 3530 - 30mm, BIO

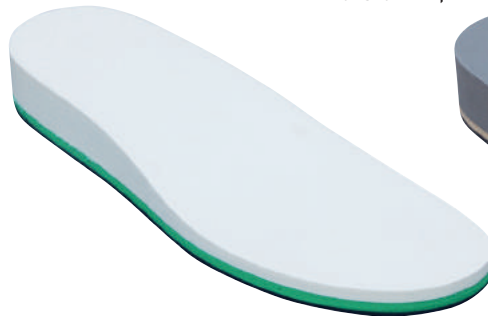

ORTHO-FORM XEM-12
5/25 Extrafoam sh35 - white, BIO
+ Extrafoam sh25 - green - 5mm
+ Extrafoam sh50 - dark blue - 2mm



ORTHO-FORM XC50-02
10/30 EVACAD/50 - dark gray 128, BIO
+ Termolast/30 - 4mm
+ Hardair - black - 2mm



ORTHO-FORM
10/30 EVA MARBLE/50 - pink, BIO



ORTHO-FORM XK45-08
10/30 EVA CORK/45, BIO
+ Duralux 1,2mm



ORTHO-FORM
10/30 EVA MARBLE/40 - black
BIO



Beispiele - examples - voorbeelden - exemples

OHNE PELOTTE
 WITHOUT PAD
 ZONDER PELOT
 SANS PELOTTE



20503
 EVA CORK/45
 + Duralux



20505
 EVA CORK/45
 + rundcrouete leather



20502
 rubber cork
 + Duralux



20504
 rubber cork
 + rundcrouete leather



7520513
 EVACAD/60

MIT PELOTTE
 WITH PAD
 MET PELOT
 AVEC PELOTTE



20523
 EVA CORK/45
 + termolast retrocap. steun
 + rundcrouete leather



20589
 EVA CORK/45
 + drop pad
 + Duralux 1,2mm + Reflex 3mm

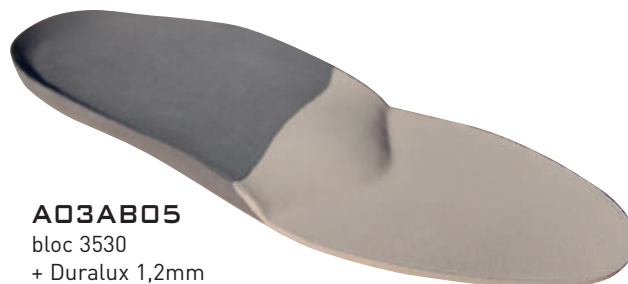

A03AB05
 bloc 3530
 + Duralux 1,2mm

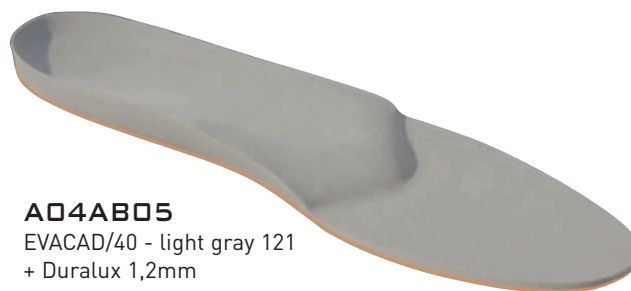

A04AB05
 EVACAD/40 - light gray 121
 + Duralux 1,2mm



A05AB05
 EVA MARBLE/50 - marine blue
 + Duralux 1,2mm



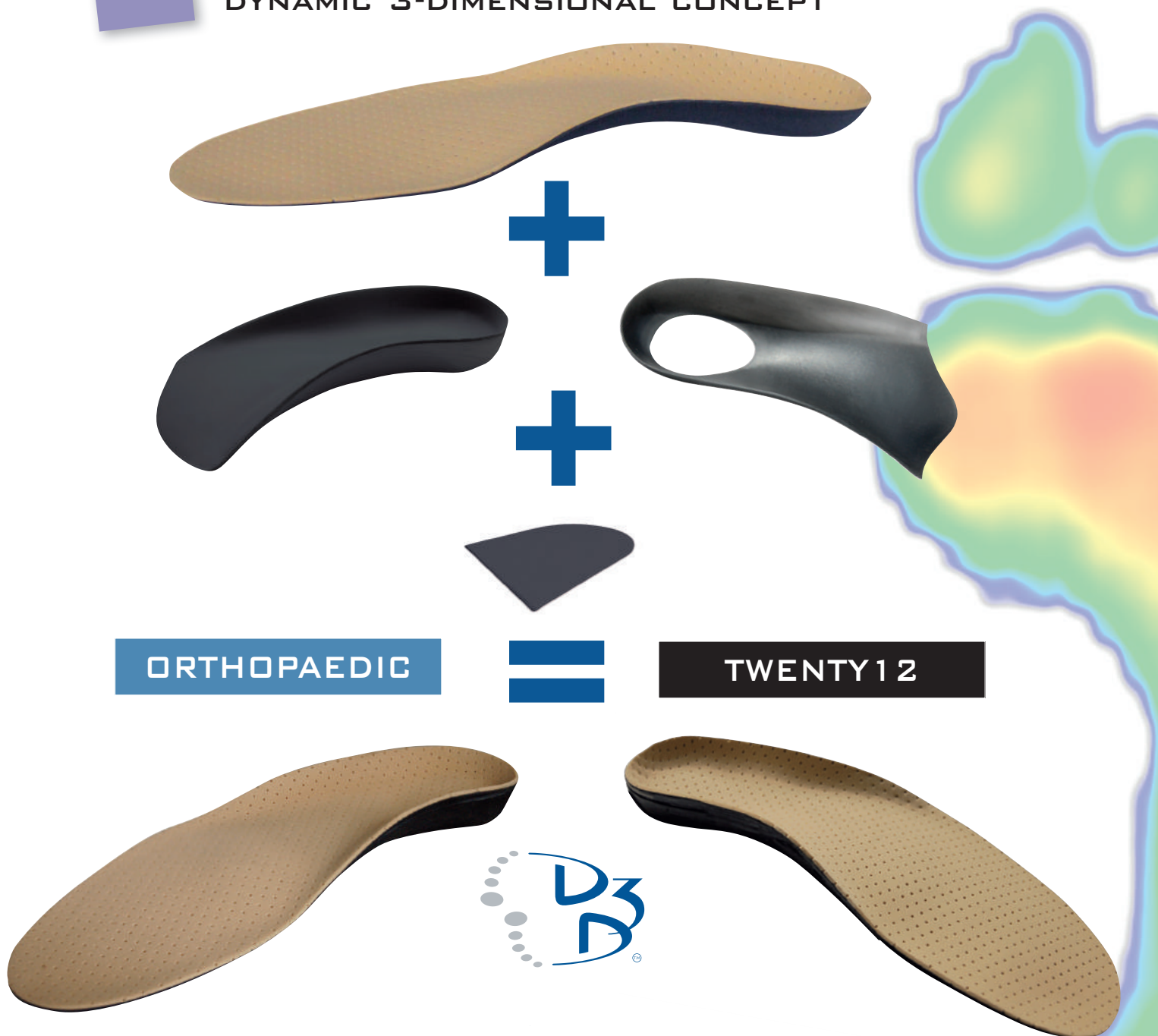

DYNAMIC 3-DIMENSIONAL CONCEPT

D3D is an automated system based on footscan® measurements and calculations that provides a proposal for insoles with a modular construction and external added corrections. D3D insoles exist for a whole range of people, from diabetics to top athletes, and can be used for daily life as well as for (intensive) sports activities, both preventive as curative.

Die Basis-Einlagen, Decksohlen und Korrektur-elemente können zu einer perfekten Einlage für den Benutzer und dessen Aktivitäten kombiniert werden.

Combineer de basiszolen, bovenzolen en correctie-elementen om een perfecte steunzool te maken, aangepast aan de activiteiten van de gebruiker.

Combinez les supports de base, les semelles de recouvrement et les corrections pour créer une semelle orthopédique parfaitement adaptée aux activités du client.



footscan®

Step 1: footscan® pressure measurement

The high recording speed of the footscan systems, up to 500 frames of data per second, allows a highly accurate analysis of the pressure distribution. This will give you a clear view on the movement of the foot and its mechanics.

To meet the demands of different users, Rsscan International developed several software and hardware packages. Hardware packages available from entry level/0,5mplate/300Hz up to hi-end level 500Hz/3D interface box/2m plate.

Step 2: orthotic proposal via footscan software

The footscan software decides which different modules to combine in order to obtain the best fitting D3D orthotics. The composition made by the software is only a proposition and can be altered by the user based upon his own experience.

The D3D concept is build-in in the footscan® Gait Software package (available levels: Basic, Clinical & Scientific), which is specially developed to analyze the static and dynamic plantar foot pressures. This software also offers a lot of graphs and figures to make an adequate diagnosis. It is available on all footscan® pressure plate systems.

Step 3: fabrication of the footscan® orthotics (insole)

The different modules are molded out of the best EVA material. The various basic inlays, top layers and correction elements can be combined, glued and scoured to make a perfect insole for the customers' activity requirements.

The footscan® D3D orthotics can predict and reduce lower limb injuries.

A study of the Britannia Royal Naval College (Dartmouth, UK) concludes that injury rate of military professionals can be predicted and reduced with the RSscan footscan® D3D-system. This was the first and largest randomised controlled study ever undertaken worldwide to compare orthotic use with injury reduction. A reduced injury rate of 31% was found!

Reference: **Foot Orthoses in the Prevention of Injury in Initial Military Training - A Randomized Controlled Trial**
Andrew Franklyn-Miller, MBBS, Cassie Wilson, z PhD - James Bilzon, z PhD, and Paul McCrory, y PhD

1

TOP COVER - DECKSOHLE - BOVENZOOL - SEMELLE DE RECOUVREMENT



7801.212	7801.254	7801.121	7801.017	7801.010	7801.028	7801.039	7801.035	7801.051	7801.070
Elastoflex light blue Sh.A15 5mm diabetic/low hardness/very high elasticity UK sizes 1-15	Highflex orange Sh.A25 5mm sport/very high rebounding effect UK sizes 1-15	Termolast skin colour Sh. 20A - 40C 5mm diabetic/comfort UK sizes 1-13	Extrafoam green Sh. 25A - 45C 5mm diabetic/comfort UK sizes 1-13	Extrafoam light grey Sh. 25A - 45C 5mm comfort UK sizes 4-15	Extrafoam blue Sh. 35A - 55C 5mm comfort/sport/ <70 kg UK sizes 1-15	Extrafoam red Sh.50A - 70C 5mm high perform./ >70kg UK sizes 1-15	Extrafoam dark blue Sh. 50A - 70C 3,5mm high perform./ >70kg UK sizes 1-15	Hardair + Termolast Perfo black + beige Sh. 60A + sh.30A 5mm diabetic/stability UK sizes 2-15	Hardair black Sh. 60A - 80C 2,5mm extra thin sport/high perform UK sizes 2-15

2

BASIC INLAY - BASIS EINLAGE - BASISZOOL - SUPPORT DE BASE

D3D ORTHOPAEDIC INSOLES



7803.221F Termolast skin colour Shore 30A - 45C diabetic/comfort UK sizes F1-15 / N2-15	7803.028N 7803.028F Extrafoam blue Shore 35A - 55C comfort/sport/<70kg UK sizes F1-15 / N2-15	7803.040N 7803.040F Softair black Shore 45A - 65C comfort/high performance UK sizes F1-15 / N2-15	7803.036N 7803.036F Extrafoam white Shore 50A - 70C high performance/>70kg UK sizes F1-15 / N2-15	7803.100N 7803.100F It-Air Cork cork Shore 60A - 80C very high perform./heavy persons UK sizes F1-15 / N2-15
---	---	---	---	--

D3D TWENTY12 BLACK

N = high arch, hohes Fuß-Gewölbe, hoog gewelf, voûte prononcée
F = low arch, tiefes Fuß-Gewölbe, laag gewelf, voûte basse

NOTE:
 shoe size equals top cover size. Always order top cover size.
 shell size = -1 size.

7803.500N
7803.500F
 black polypropylen shell
 ultra thin, ultra stable, ultra fit
 UK sizes 2-13



SIZES - GRÖSSEN - MATEN - POINTURES



Also deliverable
in very big sizes



CORRECTION - KORREKTURELEMENT - CORRECTIE - ÉLÉMENT DE CORRECTION

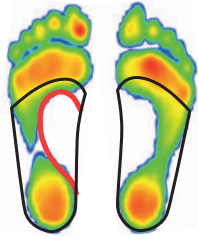

FOREFOOT
ANTI-PRONATION

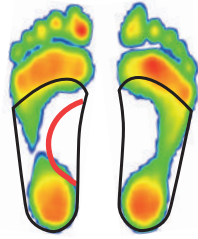

MIDFOOT
SUPPORT

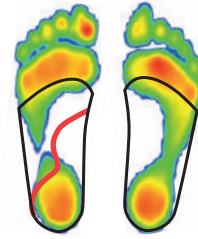

REARFOOT
ANTI-PRONATION

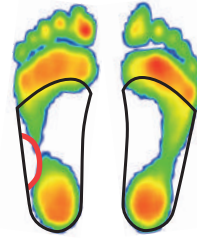

ANTI-SUPINATION
SUPPORT



CURVED - GEBOGENE - GEBOGEN - COURBÉ

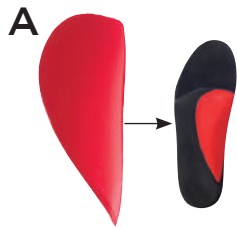

7806.039.A

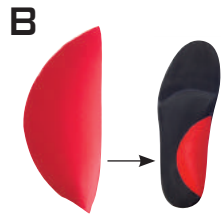

7806.039.B

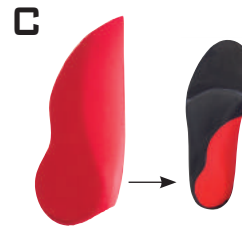

7806.039.C

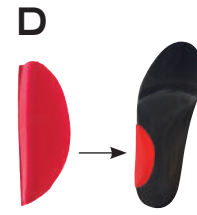

7806.039.D

Extrafoam, red
Shore 50A - 70C

FLAT - FLACH - VLAK - PLAT

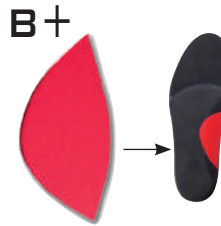

7830.2902.B (136p)
7830.2904.B (136p)
7832.2902.B
7832.2904.B

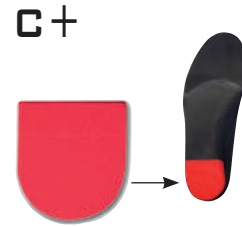

7830.3902.C (94p)
7830.3904.C (94p)
7832.3902.C
7832.3904.C

Extrafoam, red
2mm, Shore 35A - 55C
4mm, Shore 50A - 70C
2mm, Shore 35A - 55C
4mm, Shore 50A - 70C



7830.6002.A (110p)
7832.6002.A

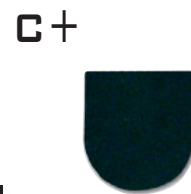

7830.6002.C (138p)
7830.6004.C (141p)
7832.6002.C
7832.6004.C



7830.6002.DF (114p)
7832.6002.DF
Noène, black
2mm
4mm
2mm
4mm



PER 5 PAIRS
CUT AND PACKED PER SHEET (quantity/pack)
CUT AND PACKED PER 10 PAIRS

ORTHOPAEDIC INSOLES

examples - Beispielen - voorbeelden - exemples

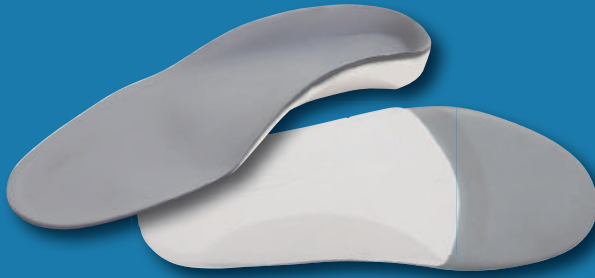

SPORT
75 D3 232 N/F

Cover: Extrafoam grey
Base: Extrafoam white
Shore: 50

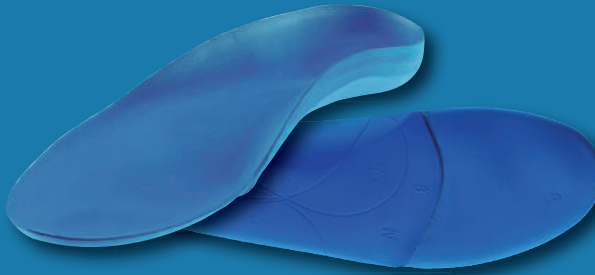

SPORT
75 D3 102 N/F

Cover: Extrafoam royal blue
Base: Extrafoam blue
Shore: 35



SPORT
75 D3 203 N/F

Cover: Extrafoam red
Base: Extrafoam white
Shore: 50

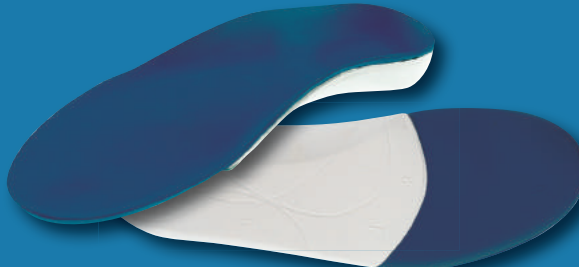

SPORT
75 D3 204 N/F

Cover: Extrafoam dark blue
Base: Extrafoam white
Shore: 50



DUO LAYER • DIABET
75 D3 409 N/F

Cover: Hardair + Termolast Perfo
Base: Softair
Shore: 45A - 65C

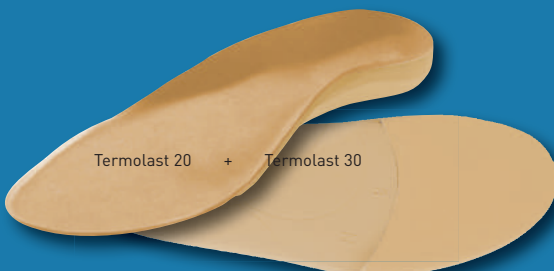

DIABET
75 D3 307 N/F

Cover: Termolast 20
Base: Termolast 30
Shore: 30



KIDS
75D3-701FR
75D3-701NR



KIDS
75P13240

Half sole
Kurzsohlig
Halfzool
Semelle courte



KIDS
75P11240

Full sole
Langsohlig
Langzoolig
Semelle entière



KIDS



Colour differences between print and original product are possible.
Farbabweichungen zwischen dem Farbdruck und dem Originalprodukt sind möglich.
Kleurverschillen tussen het drukwerk en het origineel product zijn mogelijk.
Des différences de couleur entre l'imprimerie et le produit originale sont possible.

TWENTY12 INSOLES

Beispiele - examples - voorbeelden - exemples



75 D3B021 N/F
Cover: Termolast
Base: 'Black'
Shore: 20



75 D3B017 N/F
Cover: Extrafoam green
Base: 'Black'
Shore: 25



75 D3B010 N/F
Cover: Extrafoam grey
Base: 'Black'
Shore: 25



75 D3B060 N/F
Cover: EVA marble black
Base: 'Black'
Shore: 30



75 D3B028 N/F
Cover: Extrafoam blue
Base: 'Black'
Shore: 35



75 D3B039 N/F
Cover: Extrafoam red
Base: 'Black'
Shore: 50



75 D3B035 N/F
Cover: Extrafoam dark blue
Base: 'Black'
Shore: 50



75 D3B051 N/F
Cover: Duolayer
Base: 'Black'



75 D3B070 N/F
Cover: Hardair black
Base: 'Black'
Shore: 60



- ULTRA THIN
- ULTRA STABLE
- ULTRA FIT
- TIMESAVING PRODUCTION

7803.500N
7803.500F



D3D SLIM ELEGANT INSOLES

Insoles based on the D3D lasts, perfectly suited for fine classic shoes.
 Einlagen basierend auf den D3D Leisten, ideal für klassische, feine Schuhe.
 Steunzolen gebaseerd op de D3D-leesten, perfect in fijne klassieke schoenen.
 Semelles à base des formes D3D, parfait pour des chaussures classiques.

Beispiele - examples - voorbeelden - exemples

**SLIM SKAI • SMOOTH****75L28N01****75L28F01**

Cover: 4/4 Skai

Intermediate layer: Elegant / Elegant-Heelspur

Base: Softair

New Top cover for the Slim Skai elegant insole!

The new Thermytex cover is our latest generation of synthetic cover materials, with a much higher quality than the former Skai. Its main added value is **high absorption of humidity!**

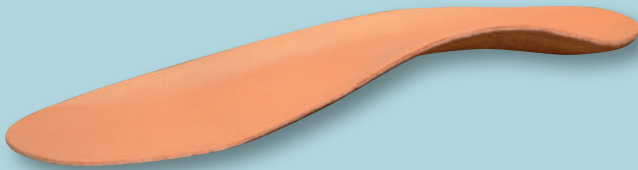
**SLIM LEATHER • STYLE****75L11N01****75L11F01**

Cover: 4/4 full sole in leather

Intermediate layer: Elegant / Elegant-Heelspur

Base: 1/2 Suetex, middle brown

**SLIM PPT ULTRALUX • CUSHIONING****75L34N01****75L34F01**

Cover: 4/4 PPT Ultralux, blue, 1,6mm

Intermediate layer: Elegant / Elegant-Heelspur

Base: 1/2 Suetex, dark blue

**SLIM EVA • STIFF****75L26N01****75L26F01**

Cover: 4/4 Hardair 2 mm, dark blue

Intermediate layer: Elegant / Elegant-Heelspur

Base: 1/2 hard-air 1.5 mm, dark blue

N = high arch, hohes Fuß-Gewölbe, hoog gewelf, voûte prononcée
F = low arch, tiefes Fuß-Gewölbe, laag gewelf, voûte basse



sizes 35-40

Ladies

sizes 41-47

Gentlemen

ZWISCHENSCHICHT - INTERMEDIATE LAYER - TUSSENBOWW - INTERCALAIRE

EXTRA ELEGANT

		7522.401	7522.402	7522.403
		weiß, hart white, hard wit, hard blanc, dur	beige, weich beige, soft beige, soepel beige, souple	opaque, Fersenspurn opaque, heel spur opaque, hielspoor opaque, épine calcanéenne
35	35/36	•	•	•
37	37/38	•	•	•
39	39/40	•	•	•
41	41/42	•	•	•
43	43/44	•	•	•
45	45/46	•	•	•
47	47/48	•	•	



INTERMEDIATE LAYER 'ELEGANT-HEELSPUR'
 With cut-out for cushioning the heel zone while relieving the tendon. For insoles for patients with heel(calcaneal) spur.
 Can be used in all our Slim Elegant insoles.
 Also separately available in 2 different hardnesses.

BASIC SHELL LARGE

		7522.301
		+ Pelot + pads + pelot + pelotte
35	35	•
bis to t/m à	bis to t/m à	
46	46	



A DECKSOHLEN - COVER - BOVENBOUW - RECOUVREMENT: EXTRAFOAM

- 1** Wählen Sie Ihr Modell
Choose the model
Kies het model
Choisissez le modèle

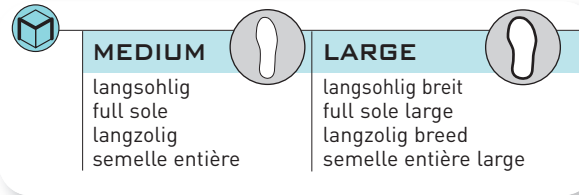

- 2** Wählen Sie das material/die Härte
Choose the material/hardness
Kies het materiaal/de hardheid
Choisissez le matériel/la dureté



- 3** Wählen Sie Ihre Farbe
Choose the colour
Kies de kleur
Choisissez la couleur

EXTRAFOAM, MULTICOLOUR, AQUA/MARBLE

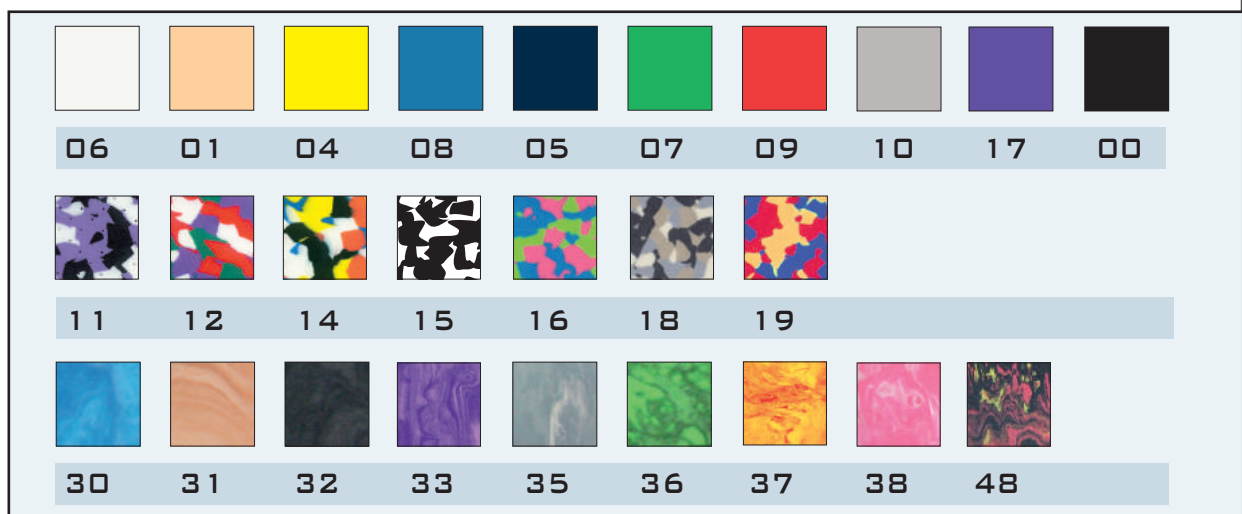

- 4** Wählen Sie die Stärke
Choose the thickness
Kies de dikte
Choisissez l'épaisseur

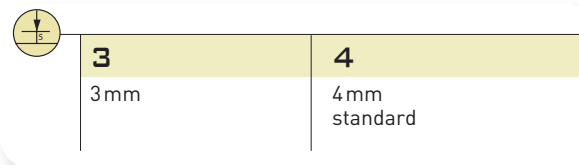

- 5** Wählen Sie die Ausführung
Choose the finish
Kies de afwerking
Choisissez la finition

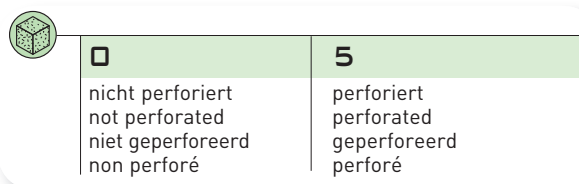

Farbabweichungen zwischen dem Farbdruk und dem Originalprodukt sind möglich.
Colour differences between print and original product are possible.
Kleurverschillen tussen het drukwerk en het origineel product zijn mogelijk.
Des différences de couleur entre l'imprimerie et la produit originale sont possible.

Stellen Sie Ihre eigenen **Sport** Einlagen zusammen.
 You can combine your own **Sport** inlays.
 U kunt zelf uw **Sport** steunzool samenstellen.
 Combinez vous-même votre semelle orthopédique **Sport**

B ZWISCHENSCHICHT - INTERMEDIATE LAYER - TUSSENBOUW - INTERCALAIRE

6 Versteifung
 Stiffening tissue
 Verstijvingsstof
 Renforcement

 > part 1		ohne without zonder sans
mit with met avec		

7 Wählen Sie die Pelotte
 Choose the pad
 Kies de pelot
 Choisissez le pelotte

	mit eingedrückte Pelotte with impressed pad met perspilot avec pelotte incorporée		mit gummi Pelotte with gummi pad met gummipilot avec pelotte gummi		ohne without zonder sans
---	--	--	---	---	-----------------------------------

8 Wählen Sie das Model und die Bauweise
 Choose the model and the construction
 Kies het model en de constructie
 Choisissez le model et la construction

	geöffnet open open ouvert	geschlossen closed dicht fermé
---	------------------------------------	---

C GRUNDLAGE - BASE - BASIS - BASE: EXTRAFOAM

9 Wählen Sie das material/die Härte
 Choose the material/hardness
 Kies het materiaal/de hardheid
 Choisissez le matériel/la dureté

 > page 1.12-1.15

10 Wählen Sie die Stärke
 Choose the thickness
 Kies de dikte
 Choisissez l'épaisseur

11 Wählen Sie Ihre Farbe oder Ihr gewünschte Farbkombination
 Choose the colour or a colour combination
 Kies de kleur of een kleurcombinatie
 Choisissez la couleur ou une combinaison de couleurs



Varia Standard

Varia geschliffen
 Varia levelled
 Varia geschuurd
 Varia égalisé

examples - Beispielen - voorbeelden - exemples →



**SPORT
NON PERFO 75ED1001**



**SPORT
PERFO 75FD1011**



**SPORT
PERFO OPEN 75FA3002**



**SPORT
75ED1019**
Langsohlig medium
Full sole medium
Langzilig medium
Semelle entière medium



**SPORT
75FE1009**
Langsohlig breit
Full sole large
Langzilig breed
Semelle entière large



**SPORT
75FD1036Z**
Medium flach geschliffen
Medium levelled
Medium vlak geschuurd
Medium égalisé

EINLAGEN SPORT
INLAYS
STEUNZOLEN
SEMELLES ORTHOPÉDIQUES



75VD1001
Varia Standard



75VD1006Z
Varia geschliffen
Varia levelled
Varia geschuurd
Varia égalisé



Beispiele - exemples - voorbeelden - exemples - KIDS



KIDS 75FD3002



KIDS 75D3701FR
75D3701NR

KIDS 75P13240
Kurzsohlig
Half sole
Halfzool
Semelle courte





KIDS 75P11245
Basis It-Air-Kork
It-Air-Cork Basis
Basis It-air-kurk
Base Liège It-air



KIDS 75P11240
Langsohlig
Full sole
Langzoolig
Semelle entière

A DECKSOHLEN - COVER - BOVENBOUW - RECOUVREMENT

- 1** Wählen Sie Ihr Modell
Choose the model
Kies het model
Choisissez le modèle

	ELEGANT		MEDIUM	
	langsohlig full sole langzilig semelle entière		langsohlig medium A full sole medium A langzilig medium A semelle entière medium A	

- 2** Wählen Sie die Decksohle
Choose the covering
Kies de bekleding
Choisissez le revêtement



- 3** Wählen Sie die Ausführung
Choose the finish
Kies de afwerking
Choisissez la finition

	0	5
	nicht perforiert not perforated niet geperforeerd non perforé	perforiert perforated geperforeerd perforé

B ZWISCHENSCHICHT - INTERMEDIATE LAYER - TUSSENBOUW - INTERCALAIRE

- 4** Wählen Sie die Größe
Choose the size
Kies de maat
Choisissez la pointure

**EXTRA ELEGANT
7522.401**

weiß, hart
white, hard
wit, hard
blanc, dur



	35	47
	35/36	47/48

- 5** Wählen Sie die Pelotte
Choose the pad
Kies de pelot
Choisissez le pelotte

		mit gummi Pelotte with gummi pad met gummipelot avec pelotte gummi	ohne without zonder sans
---	--	---	-----------------------------------

- 6** Wählen Sie das Pelotte-Modell und -Bauweise
Choose the pad model and -construction
Kies het pelotmodel en -constructie
Choisissez le model et la construction de la pelotte

	geöffnet open open ouvert	geschlossen closed dicht fermé
---	------------------------------------	---



Stellen Sie Ihre eigenen **Elegant** Einlagen zusammen.
 You can combine your own **Elegant** inlays.
 U kunt zelf uw **Elegant** steunzool samenstellen.
 Combinez vous-même votre semelle orthopédique **Elegant**



GRUNDLAGE - BASE - BASIS - BASE

7 Wählen Sie Ihr Modell
 Choose the model
 Kies het model
 Choisissez le modèle



9 Wählen Sie das material/die Härte
 Choose the material/hardness
 Kies het materiaal/de hardheid
 Choisissez le matériel/la dureté



10 Wählen Sie die Stärke
 Choose the thickness
 Kies de dikte
 Choisissez l'épaisseur



11 Wählen Sie Ihre Farbe
 Choose the colour
 Kies de kleur
 Choisissez la couleur



4/4

langsohlig
 full sole
 langzilig
 semelle entière

3/4

kurzsohlig
 half sole
 kortzilig
 semelle courte



> part 1
 > part 5



Beispiele - examples - voorbeelden - exemples

A DECKSOHLEN - COVER - BOVENBOUW - RECOUVREMENT: WALKCROUPON

mit Walkledercroupon bezogen
covered with Walkcroupon
bekleed met walkcroupon
revêtues de croupon à mouler

Wählen Sie Ihr Modell
Choose the model
Kies het model
Choisissez le modèle



MEDIUM

langsohlig
full sole
langzilig
semelle entière



LARGE

langsohlig breit
full sole large
langzilig breed
semelle entière large



B ZWISCHENSCHICHT - INTERMEDIATE LAYER - TUSSENBOUW - INTERCALAIRE

nicht verfügbar / not applicable / niet van toepassing / non applicable

C GRUNDLAGE - BASE - BASIS - BASE: CORK

Wählen Sie das Material und die Größe
Choose the material and size
Kies het materiaal en de maat
Choisissez le matériel et la pointure



7522.201

Naturkork
natural cork
natuurkurk
liège naturel



7522.201V

Naturkork + Versteiffung
natural cork + stiffening
natuurkurk + verstijving
liège naturel + renforcement



23

bis
to
t/m
à

47

23/24

bis
to
t/m
à

47/48



Beispiele - examples - voorbeelden - exemples

75K12020

4/4 medium Oberbau
4/4 medium upper
4/4 medium bovenbouw
4/4 medium recouvrement



75K12030

4/4 breit
4/4 large
4/4 breed
4/4 large



75K22080

breit mit Versteiffung
large with stiffening tissue
breed met verstijving
large avec toile thermocollante



75K1308

4/4 medium mit Tropfenform Pelotte
4/4 medium with drop pad
4/4 medium met druppel pelot
4/4 medium avec goutte talonette





Stellen Sie Ihre eigenen **Kork/Leder** Einlagen zusammen.
 You can combine your own **cork/leather** inlays.
 U kunt zelf uw **kurk/leder** steunzool samenstellen.
 Combinez vous-même votre semelle orthopédique **liège/cuir**.

A DECKSOHLEN - COVER - BOVENBOUW - RECOUVREMENT: CORK

latex kork Decksohle
 latex cork cover
 latex kurk bovenbouw
 recouvrement en liège mousse

Wählen Sie Ihr Modell
 Choose the model
 Kies het model
 Choisissez le modèle

		7522.001	7522.002
		Latex Kork latex cork moussekurk liège mousse 	Latex Kork mit Pelotte latex cork with pad moussekurk met pelot Liège mousse avec pelotte 
kein Gewölbe no vault geen gewelf sans voûte			35/36 >> 45/46
A	hohes Gewölbe pronounced vault hoog gewelf voûte prononcée	36A >> 42A	
B	Standard-Gewölbe standard vault normaal gewelf voûte standard	24B >> 46B	

7520001A
 hohes Gewölbe
 pronounced vault
 hoog gewelf
 voûte prononcée



7520001B
 Standard-Gewölbe
 standard vault
 normaal gewelf
 voûte standard



7520002
 mit Pelotte
 with pad
 met pelot
 avec pelottes



7520010
 geschliffen
 levelled
 geschuurd
 égalisé



Beispiele - exemples - voorbeelden - exemples

B ZWISCHENSCHICHT - INTERMEDIATE LAYER - TUSSENBOUW - INTERCALAIRE

nicht verfügbar / not applicable / niet van toepassing / non applicable

C GRUNDLAGE - BASE - BASIS - BASE: LEATHER

Spattleder / splitleather / rundscroûte / croûte de vachette



745061.

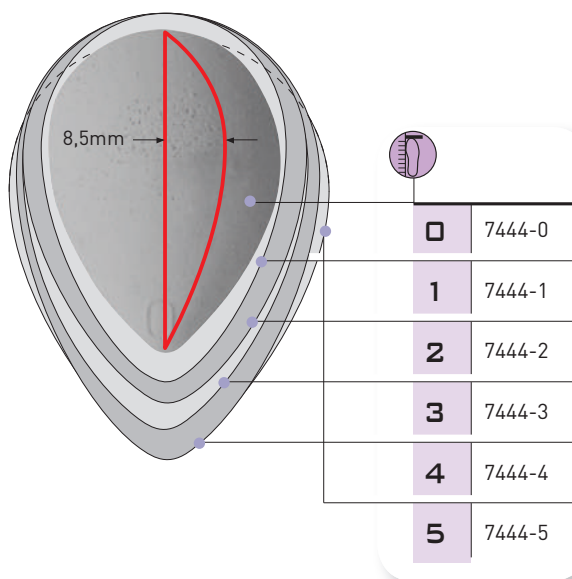

745301.

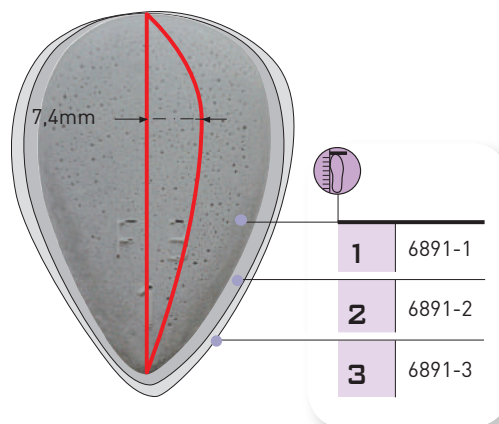

745091.

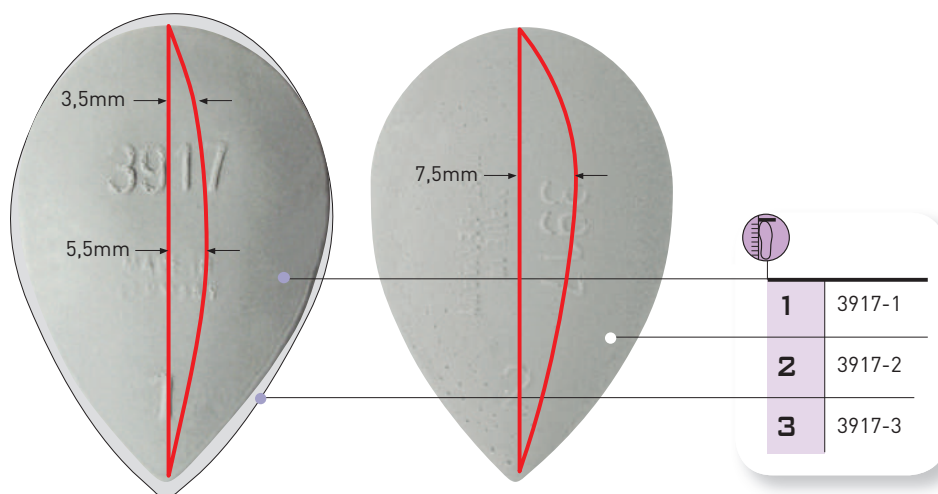

745331. 

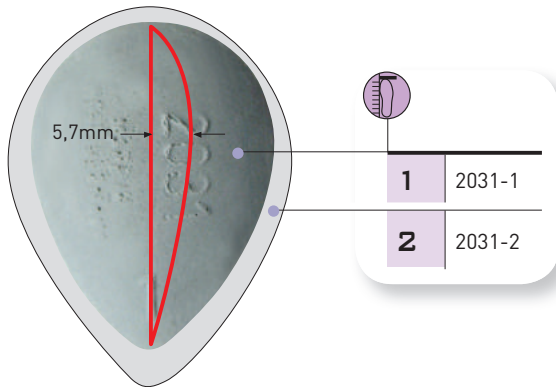

745341. 

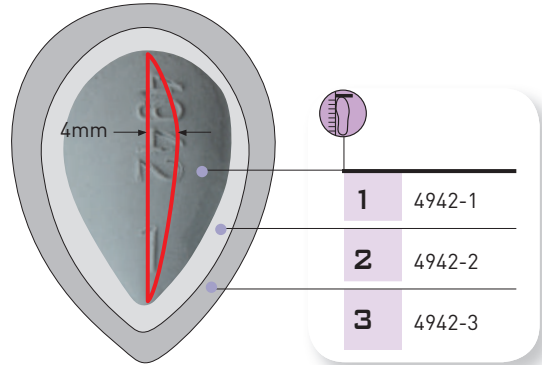

745370. 

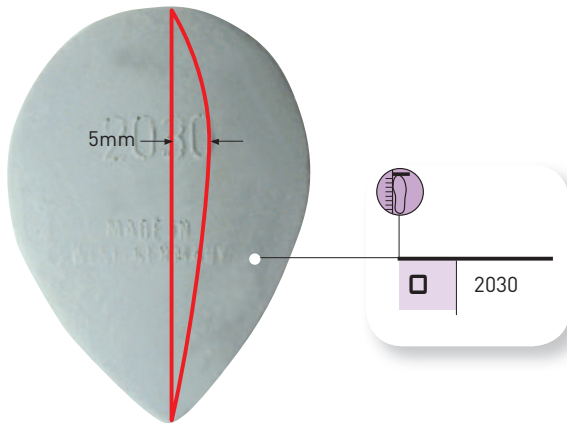

745228. 

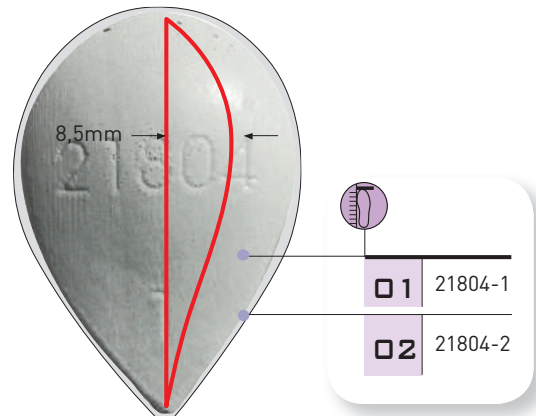



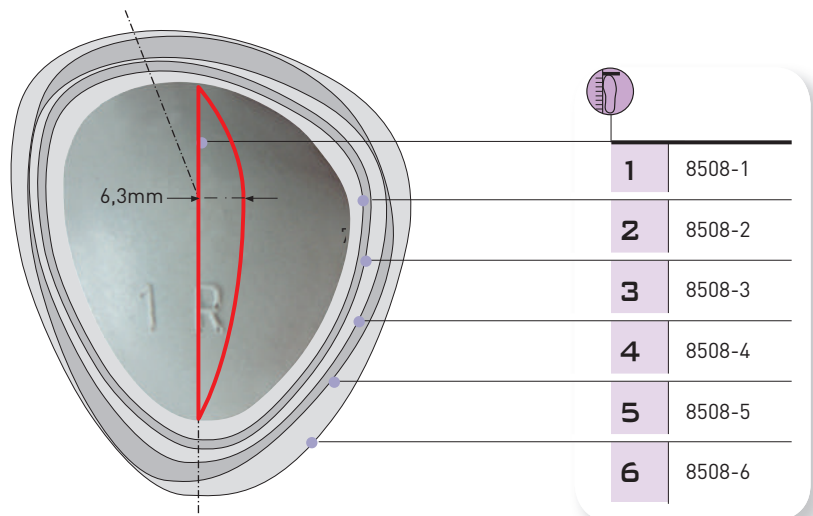

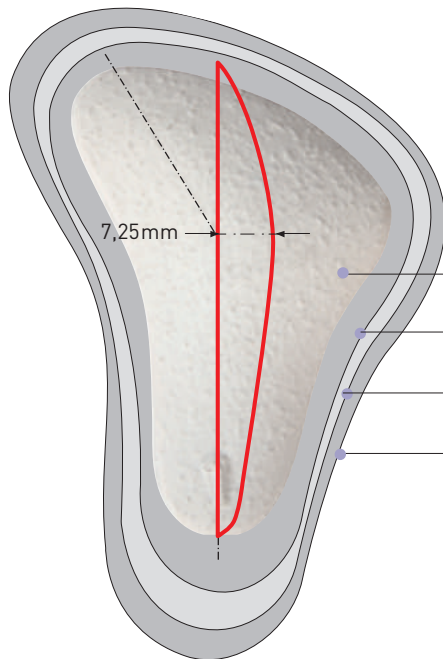

745151. 





74504.  

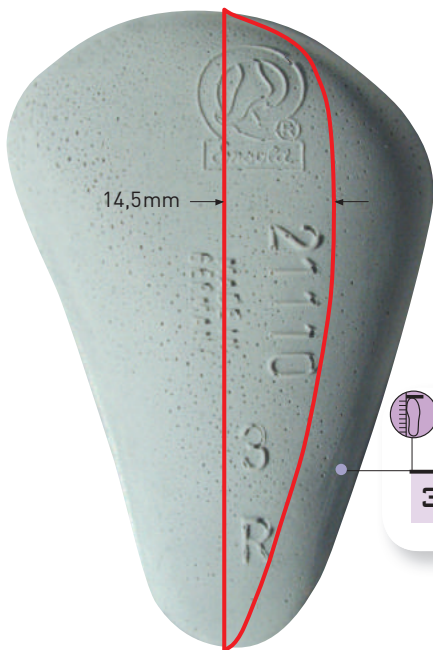

	1	3	4	5
	Latex latex latex latex	Gummi rosa rubber rosa rubber rosa caoutch. rosa	Gummi hart rubber hard rubber hard caoutch. dur	Gummi-Kork rubber cork rubberkurk liège caoutch.
				
1	7443-1	9020/060-1	9020/051-1	9020/015-1
2	7443-2	9020/060-2	9020/051-2	9020/015-2
3	7443-3	9020/060-3	9020/051-3	9020/015-3
4	7443-4	9020/060-4	9020/051-4	9020/015-4

745051. 



	3	21110/000-3
---	----------	-------------

745071. 

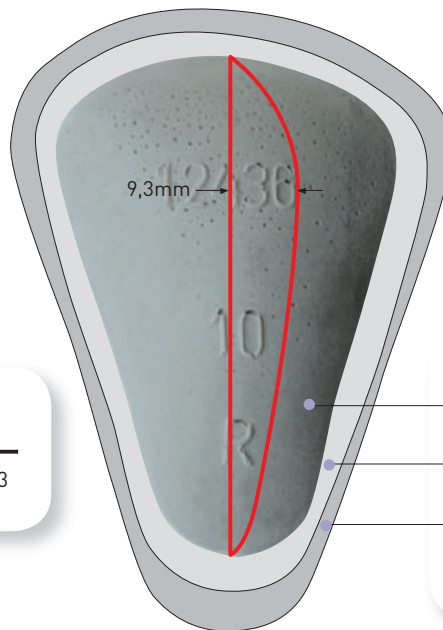

	10	12436-10
	11	12436-11
	12	12436-12



745101.

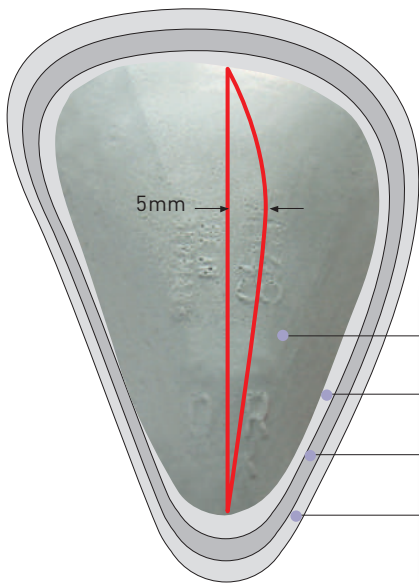

0	6648-0
1	6648-1
2	6648-2
3	6648-3

745131.

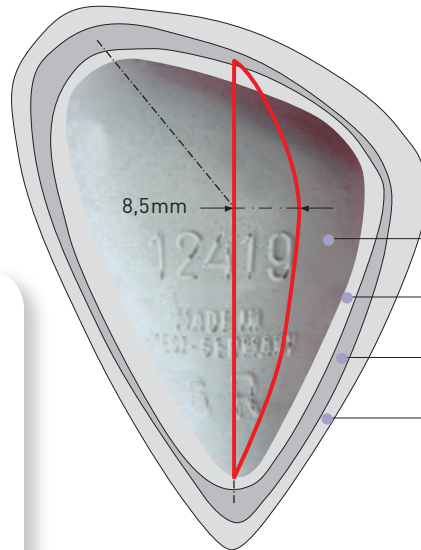

06	12419-6
07	12419-7
08	12419-8
09	12419-9

745361.

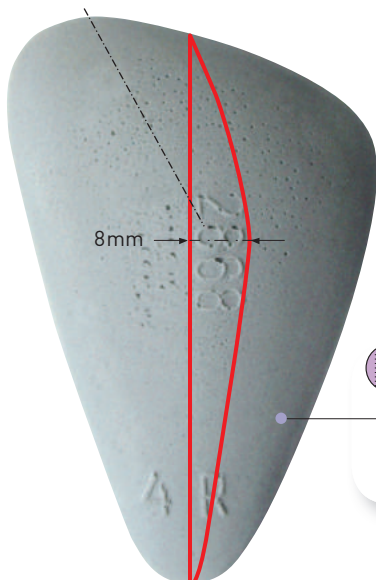

4	2868-4
---	--------

745191.

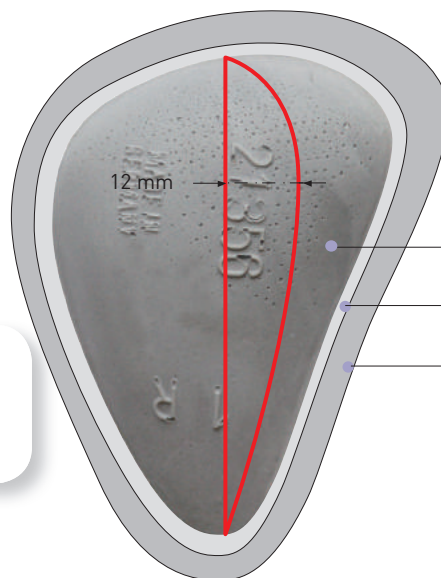

1	21356 -1
2	21356 -2
3	21356 -3

3.04

PELOTTEN
PADS
PELOTTEN
PELOTTES

745261. 

 25p.



745291. 

 25p.

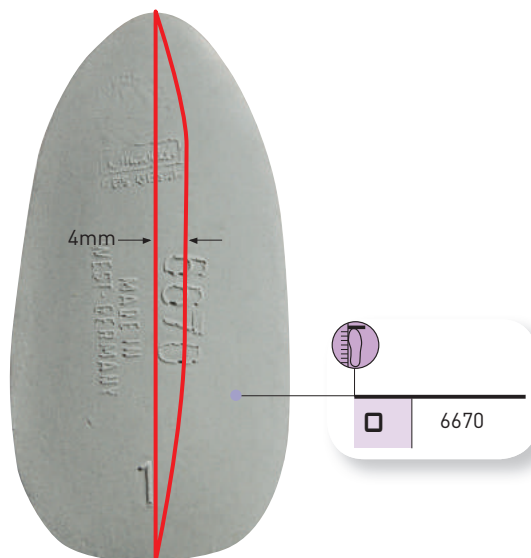

745281.

25p.



1	5594 -1
2	5594 -2
3	5594 -3

745111.



1	6222 24-27
2	6222 28-35
3	6222 3.5-8.0
4	6222 8.5-13.0
5	6222 13.5-18.0

745171.

25p.



1	21272-1
---	---------

745201.

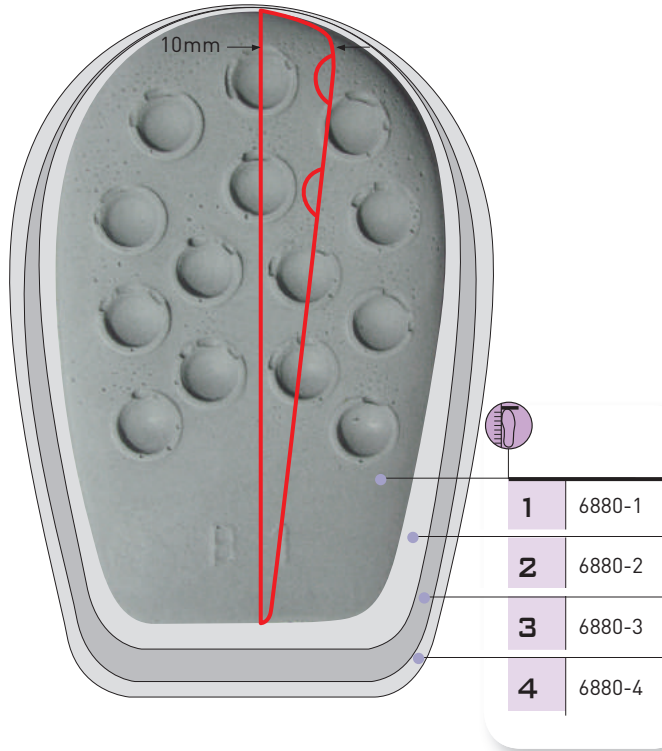

745221.

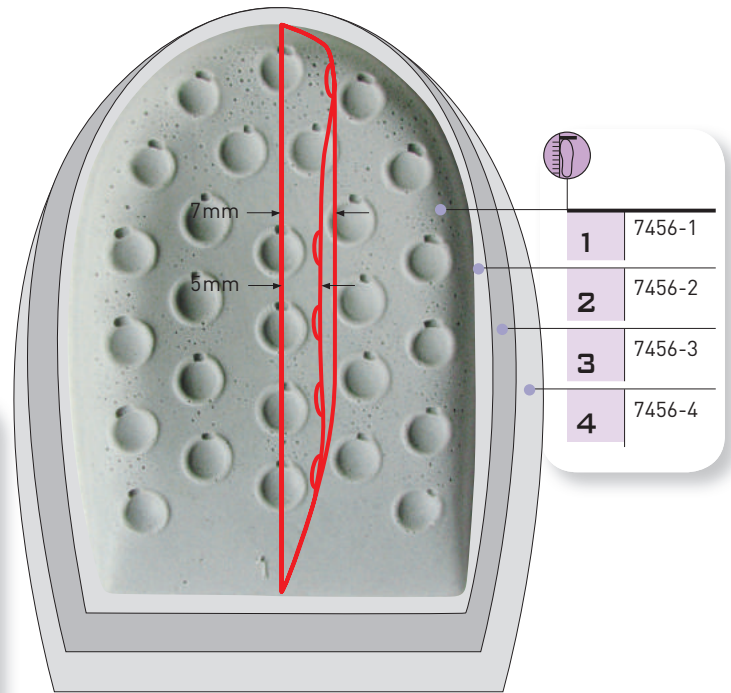

74560.

LATEX CARBOSAN PLATTEN - SHEET - PLAATJE - PLAQUE

60%

NEU
NEW
NIEUW
NOUVEAU

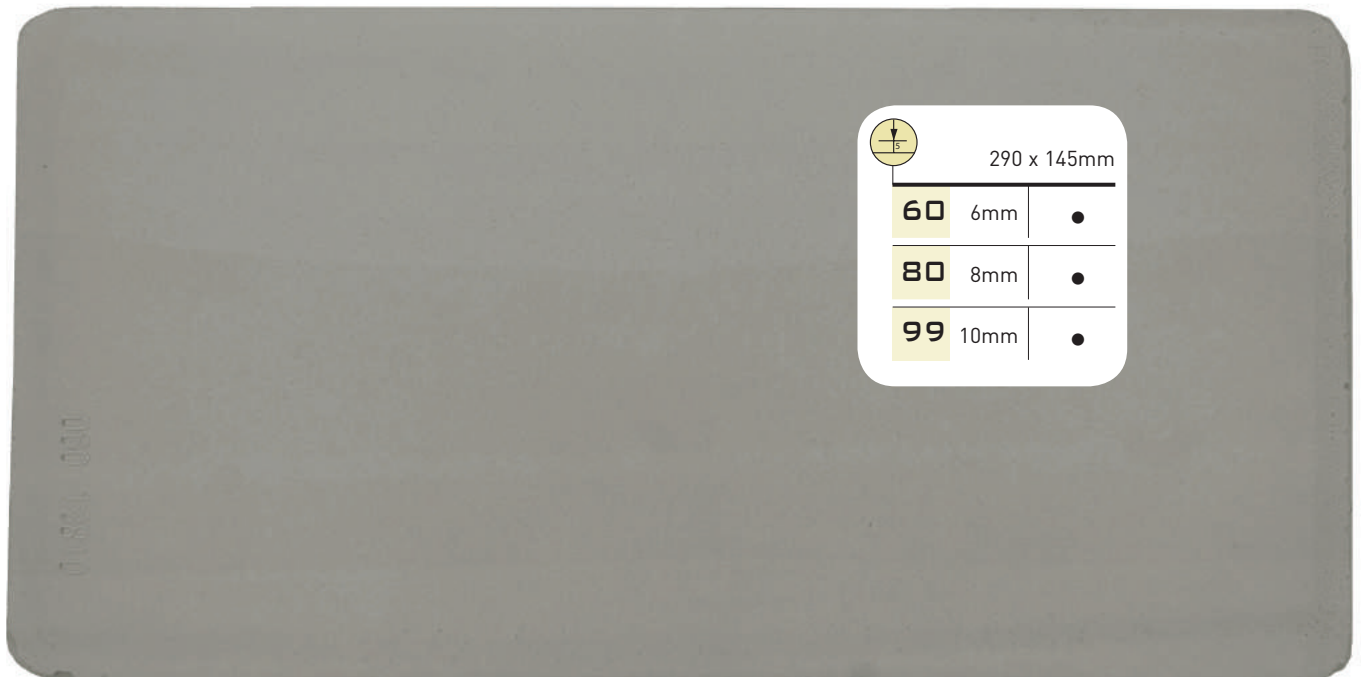



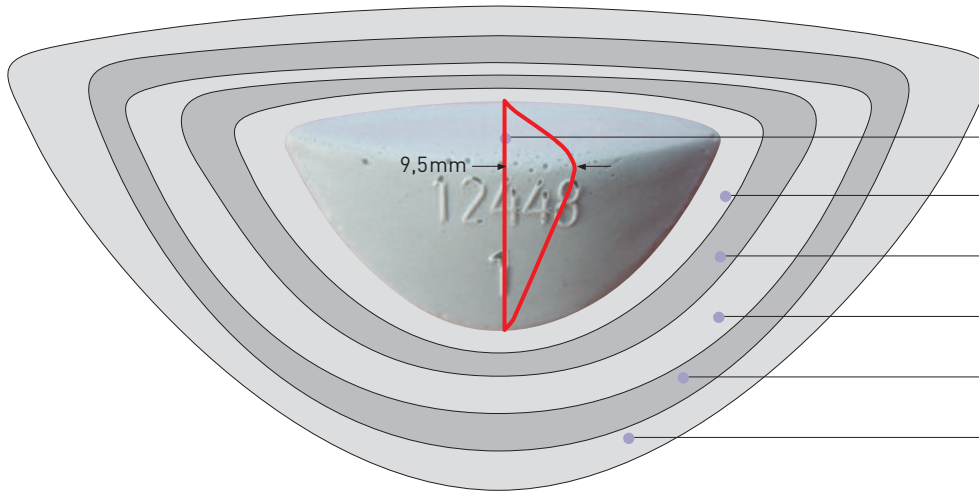

745141.

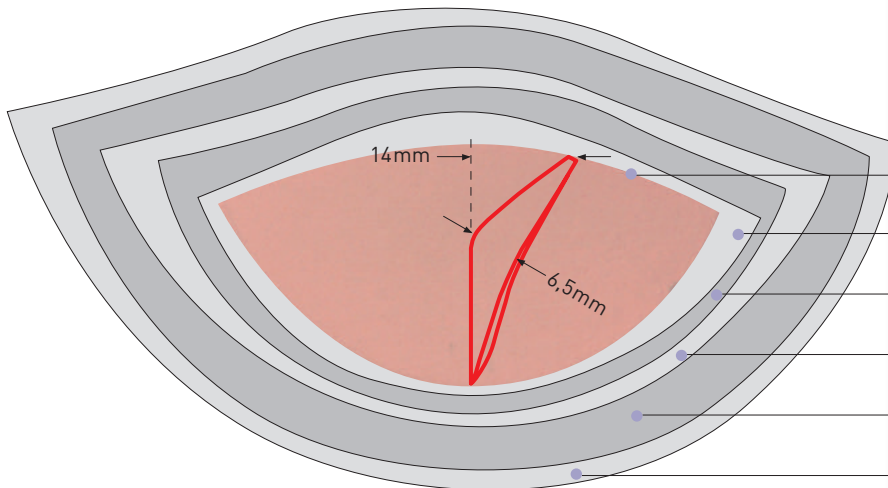

	
1	12448-1
2	12448-2
3	12448-3
4	12448-4
5	12448-5
6	12448-6

74516.



		
	3	4
	Gummi rosa rubber rosa rubber rosa cautch. rosa	Gummi hart rubber hard rubber hard caoutchouc dur
		
000	910/060-000	
001	910/060-00	
002	910/060-0	
1	910/060-1	910/020-1
2	910/060-2	910/020-2
3	910/060-3	910/020-3

745183.

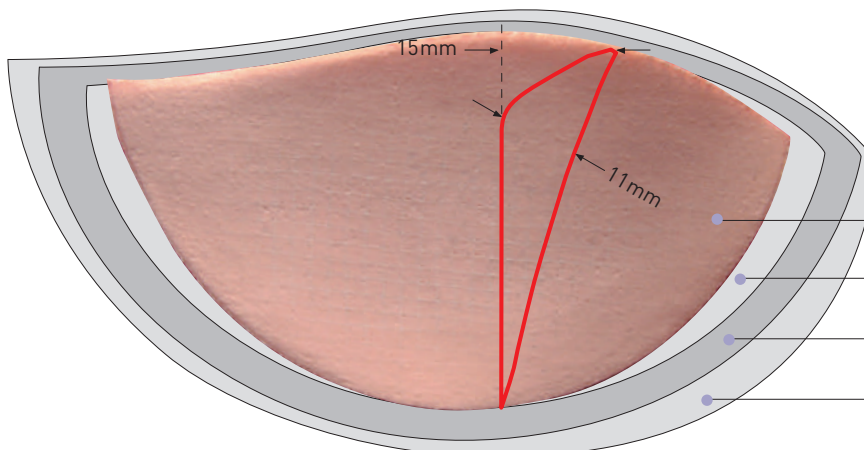

	
0	12734/060-0
1	12734/060-1
2	12734/060-2
3	12734/060-3

745001. 

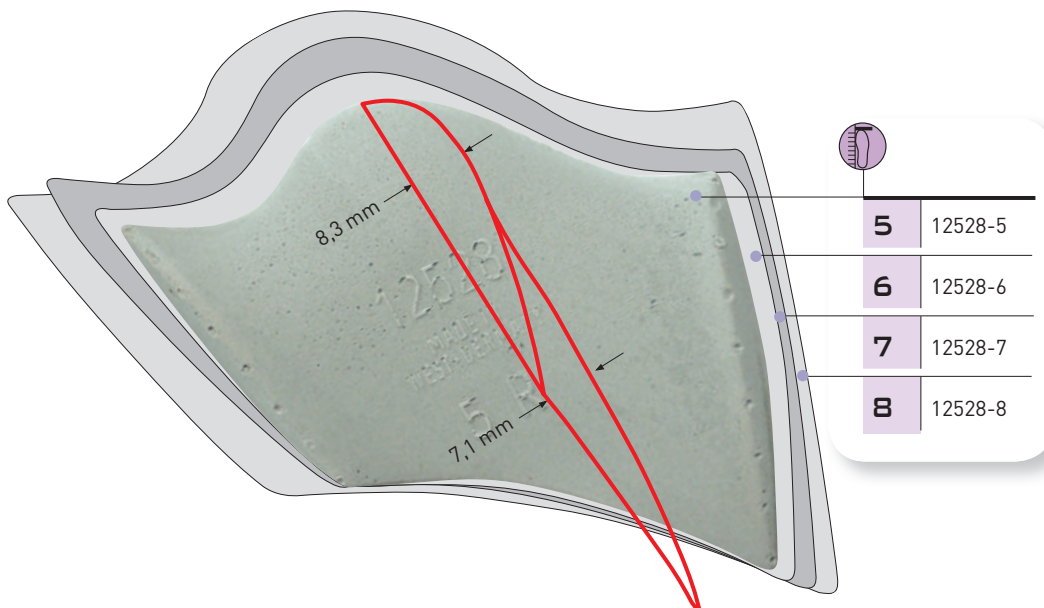

745011. 

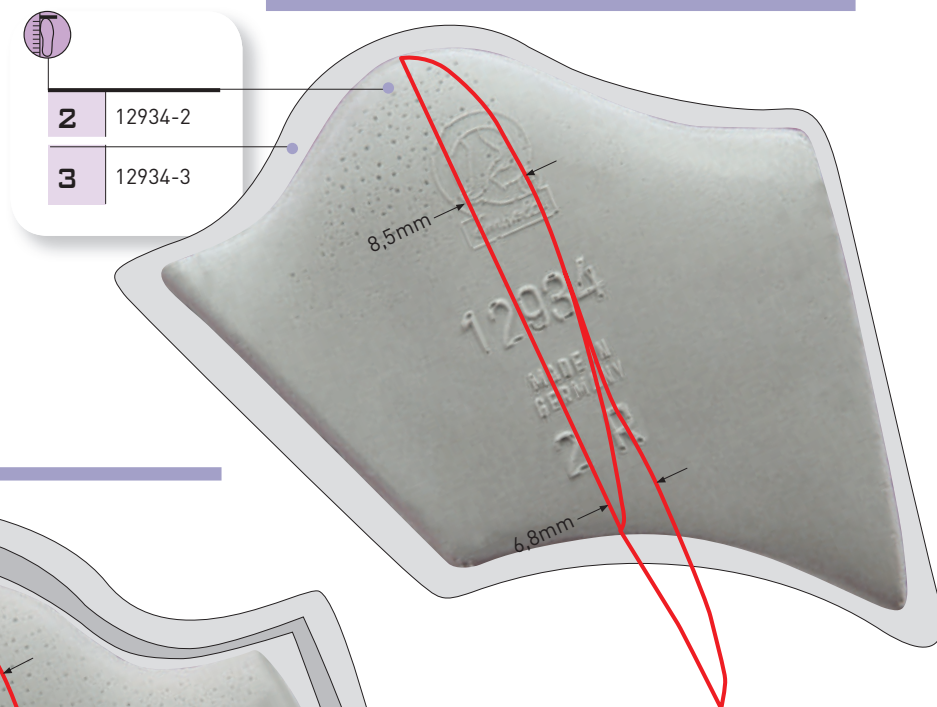

745021. 

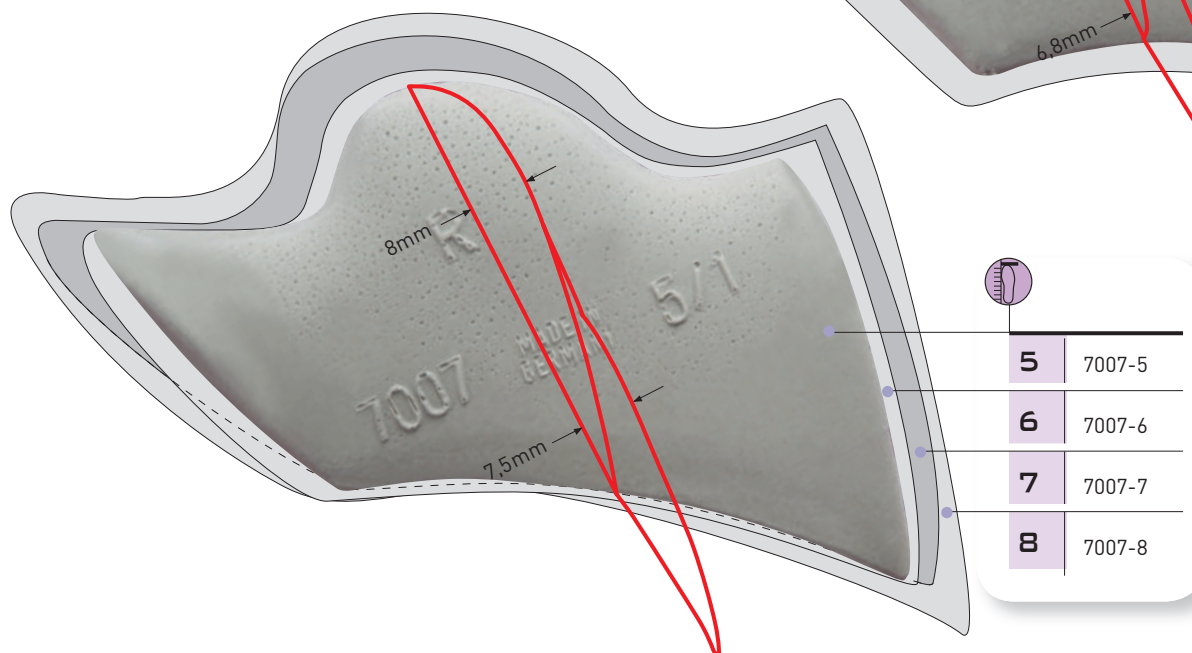

745271.

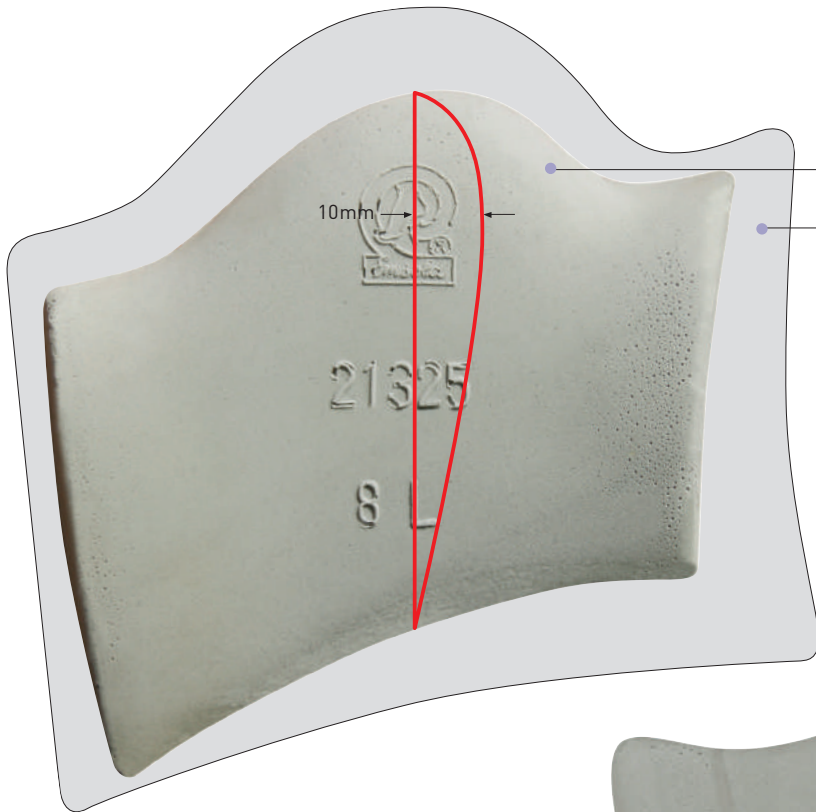

	8	21325-8
	9	21325-9

745321.

**NEU
NEW
NIEUW
NOUVEAU**

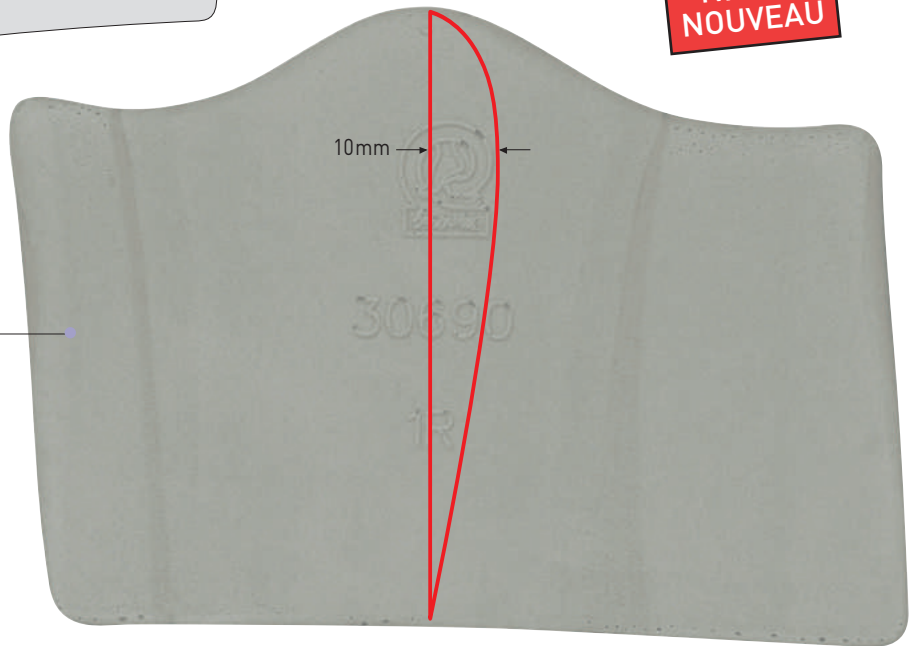

	1	30690
---	----------	-------

745401.

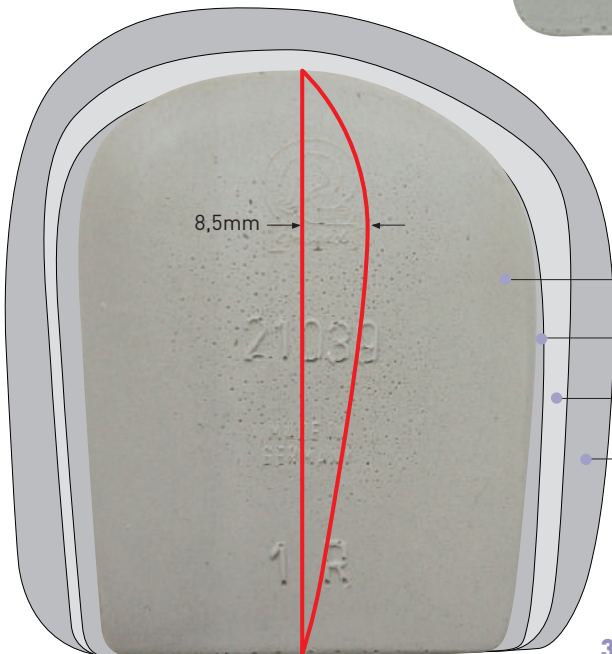

	1	21039-1
	2	21039-2
	3	21039-3
	4	21039-4

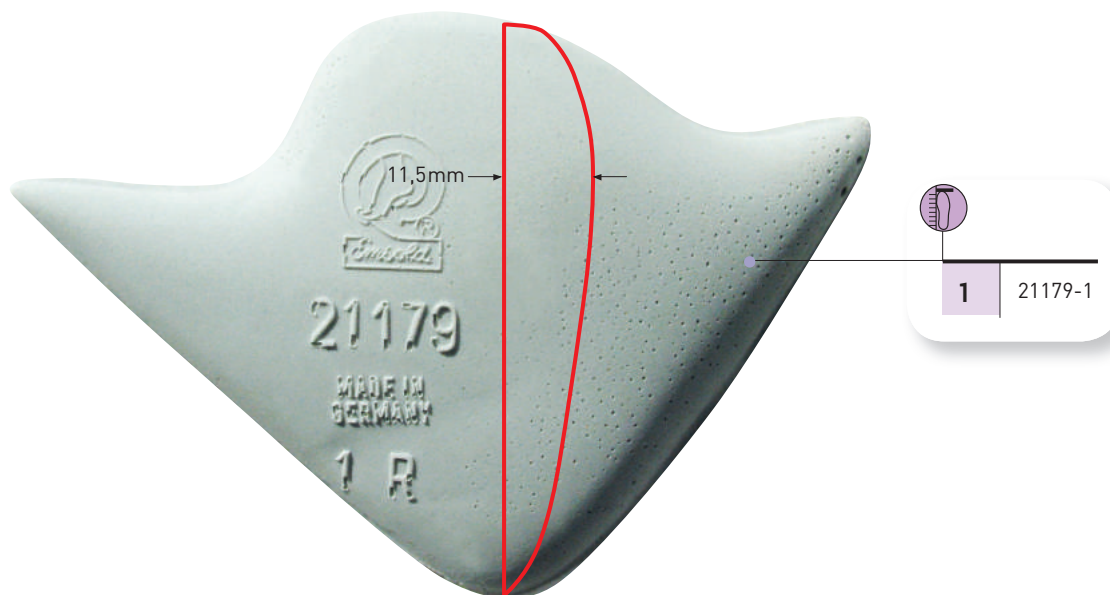
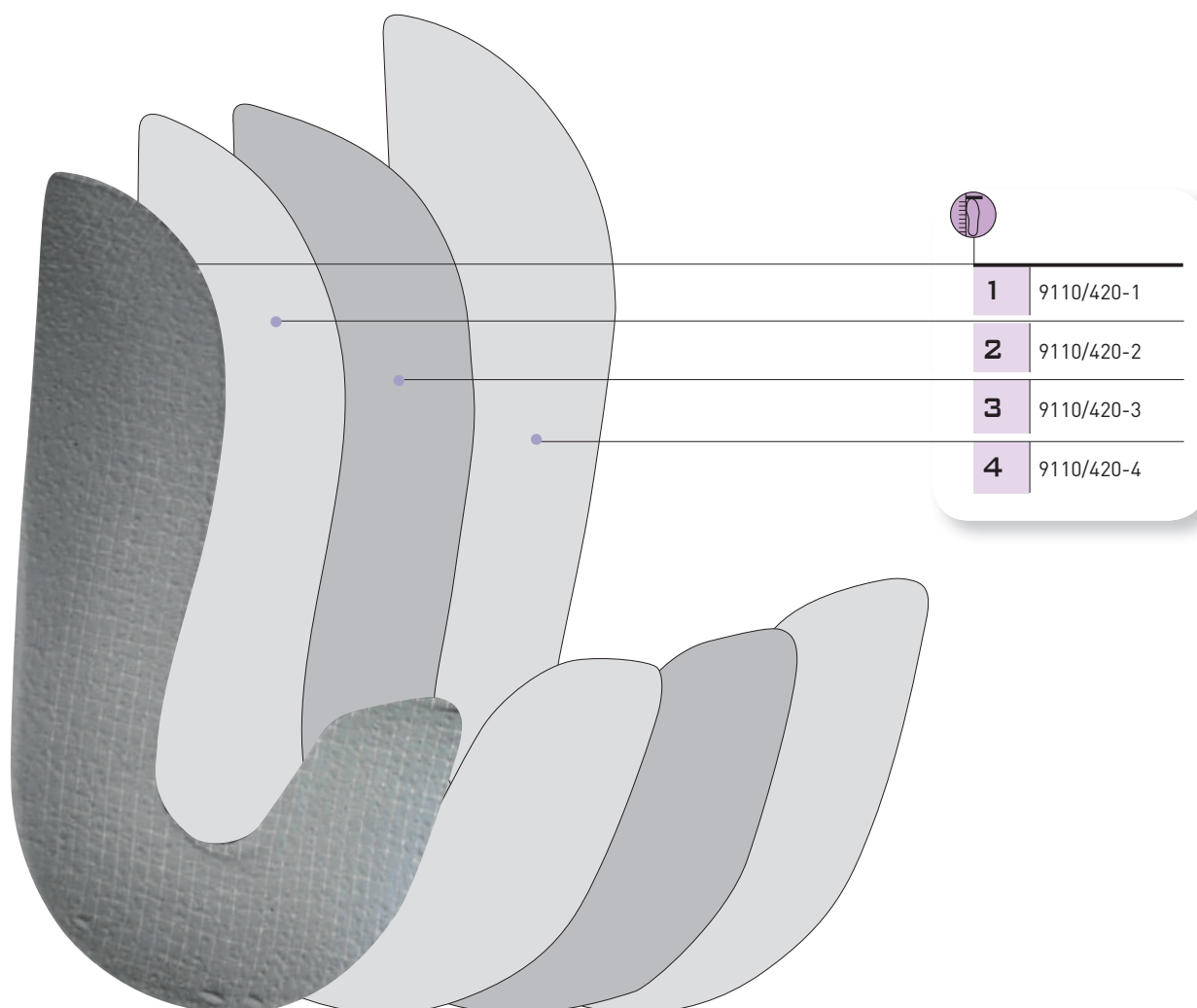
745031. 745254. 

745121.

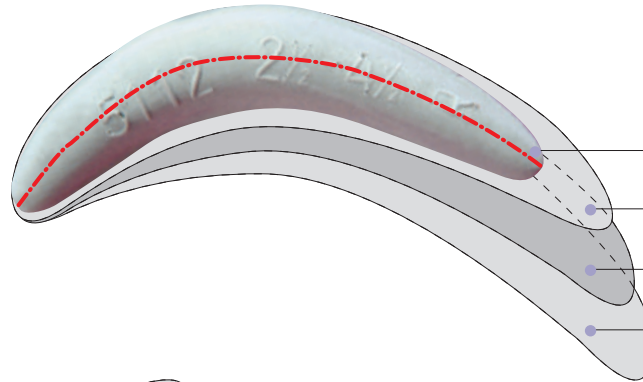

2	5112-2,5
5	5112-5,0
7	5112-7,5
9	5112-9,5

745351.

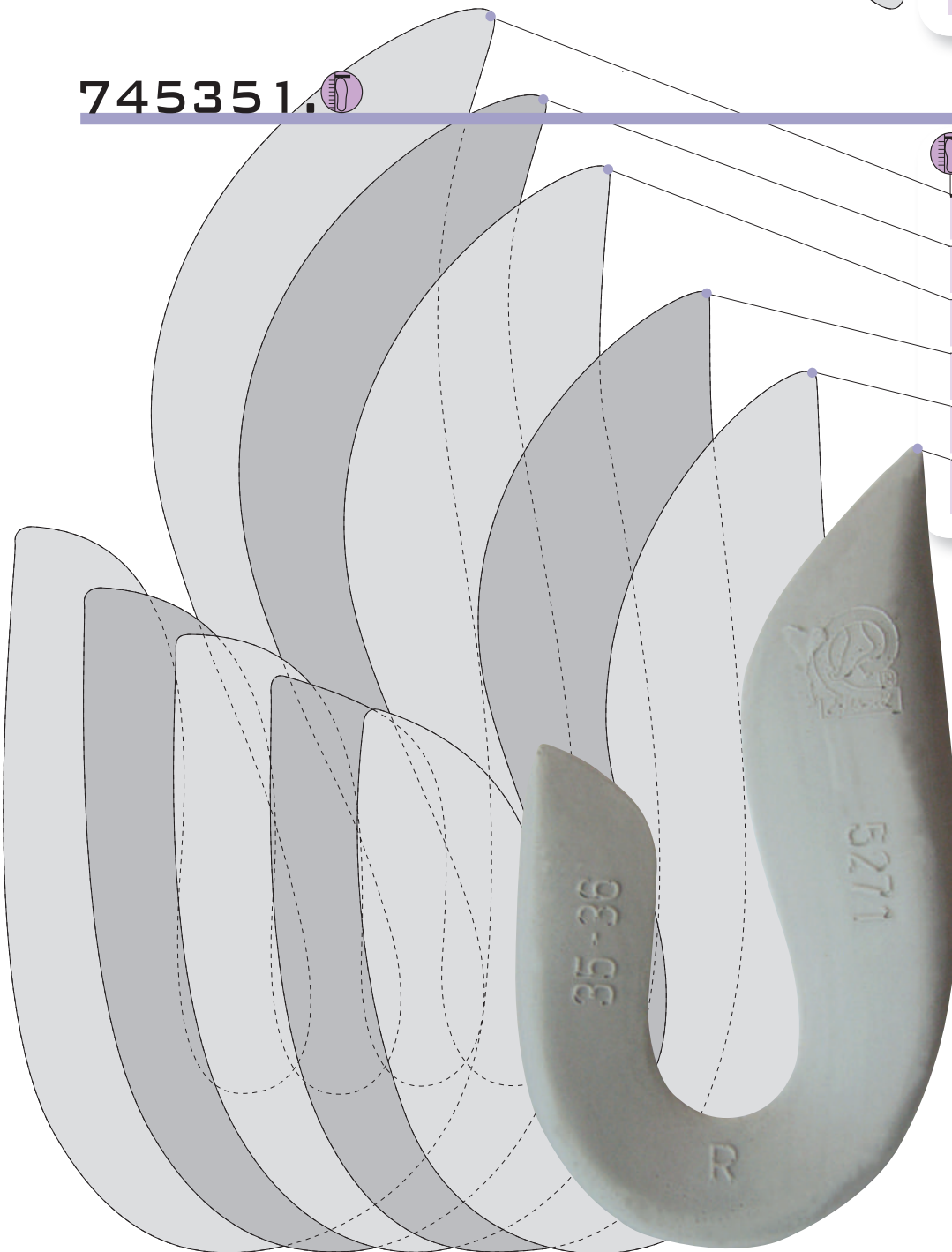

6	5271-45
5	5271-43
4	5271-41
3	5271-39
2	5271-37
1	5271-35



3.05

BIRKO SCHALENFORMEN
SHELL FORMS
SCHAALVORMEN
FORMES DE COQUILLE

1/2 BASIC 0410011.  

 1p.





	Kork cork kurk liège	
	63	64
	breit large breed large	normal normal normaal normal
24 > 50	●	
24 > 48		●

1/2 CONTACT 0410011.  

 1p.





	Kork cork kurk liège	Kork + Lederbezug cork + leather cover kurk + lederbekleding liège + recvr. en cuir
	83	85
	normal normal normaal normal	normal normal normaal normal
35 > 48	●	●

1/2 BALANCE 0410011.  

 1p.

TIEF - PRONOUNCED - DIEP - PRONONÇÉE





	Kork cork kurk liège		Kork + Lederbezug cork + leather cover kurk + lederbekleding liège + recvr. en cuir
	90	91	93
	breit large breed large	normal normal normaal normal	normal normal normaal normal
24 > 47	●	●	●

1/1 BASIC 0410010.  

 1p.



	Kork cork kurk liège
	87 normal normal normaal normal
	35 > 48

043007. 

 10p.

PELOTTEN/STÜTZEN - PADS/SUPPORTS - PELOTTEN/INBOUW - PELOTTES/SUPPORTS





	Kork cork kurk liège	Spreizfußpelotte splayfootpad spreidvoetpelot pelotte pied plat étalé	Stufenpelotte metatarsal pad retrocapitale pelot Pelottes rétrocapitales	Fersenkeile heel supinator hielsupinator supinateur talon	Gelenkteile wedge-top application gewelfverhoging prononciation voûte medial	Gelenkteile wedge-top application gewelfverhoging prononciation voûte lateral			
	4,0 cm	008	4,5 cm	011	6,0 cm	017	7,5 cm	020	6,0 cm
4,5 cm	009	5,5 cm	012	8,0 cm	018	9,5 cm	021	7,5 cm	024
5,0 cm	010	7,0 cm	013	9,5 cm	019	11,5 cm	022	9,5 cm	025

041000. 

PELOTTEN/STÜTZEN - PADS/SUPPORTS - PELOTTEN/INBOUW - PELOTTES/SUPPORTS

Latex Schaum
latex foam
latex-schuim
mousse latex



	041	042	043
		Spreizfußpelotte splayfootpad spreidvoetpelot pelotte pied plat étalé	Fersenkissen heel cushion hielkussen talonette
eine Größe one size één maat taille unique		50p.	20p.

0430070.



1

KORKPLATTE - CORK SHEET - KURKPLAAT - PLAQUE LIÈGE

45



		2	3
		Kork - weich cork - soft kurk - zacht liège - doux	Kork - hart cork - hard kurk - hard liège - dur
06	5mm	●	●
07	10mm	●	●

0420.



1

SOHLEN PLATTE - SOLE SHEET - ZOOPLAAT - PLAQUE SEMELLE

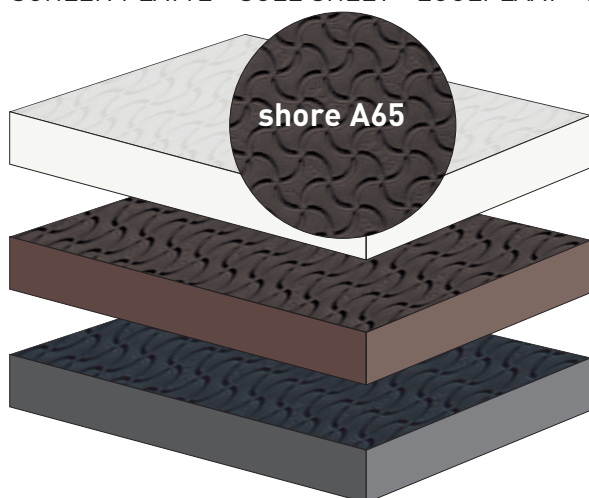

		0	1	6
		schwarz black zwart noir	braun brown bruin brun	weiß white wit blanc
07	7mm	●	●	●
10	10mm	●	●	●

04011.



1

KEILSTREIFEN - STRIPES - REPELS - BANDES BISEAUTÉES

90CM



		910	010	361
		schwarz black zwart noir	braun brown bruin brun	weiß white wit blanc
	10/70	●	●	●

CORK SCHALENFORMEN
BASE SHELL FORMS
 SCHAALVORMEN
 FORMES DE COQUILLE

03108.  

NEU
NEW
NIEUW
NOUVEAU

 1p.



SHELL

 **60**

shell
 shell
 shell
 shell

 **33/34 > 41/42**

●



NEU
NEW
NIEUW
NOUVEAU

MEDIUM

 **70**

normal
 normal
 normaal
 normal

 **36 > 48**

●



NEU
NEW
NIEUW
NOUVEAU

WIDE

 **80**

breit
 large
 breed
 large

 **36 > 48**

●

CHEMISCHE PRODUKTE
CHEMICAL PRODUCTS
CHEMISCHE PRODUCTEN
PRODUITS CHIMIQUES



AFT[®]
AFT-International.com

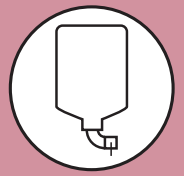

4.01	KLEBSTOFF GLUE LIJM COLLE	4.2
4.02	LEISTEN(SCHAUM) (RESIN FOR) LASTS LEESTEN(SCHUIM) (RÉSINE POUR) FORMES	4.4
4.03	WACHS/LÖSUNGSMITTEL WAX/SOLVENTS WAS/OPLOSMIDDELEN CIRE/SOLVANTS	4.6
4.04	RENIA	4.7



Rocket ist ein transparenter, einfach zu streichender Universalkleber mit perfekter Haftung, speziell für Schuhreparatur und Orthopädie geeignet.

Klebt: Gummi, Leder, PUR, TR-Material, Nylon, Textil, Holz usw. Kalt verarbeiten bei ca. 20°C. Die Flächen gut aufrauen, vom Schleifstaub befreien und beidseitig einstreichen. Der Klebstoff kann durch Wärmestrahlen jeglicher Art reaktiviert werden.

Rocket is a transparent, easy to smear universal neoprene glue with extra strong bond, especially developed for the shoe-repairer and the orthopaedist.

Glues: rubber, leather, thermorubber, nylon, textile, wood, etc. Cold glue at approx. 20°C. Roughen well, dust off and put on both sides. In case of extended waiting time, perfect adhesion can be accomplished by activating the glue.

Rocket is een transparante, gemakkelijk uit te strijken universele lijm met een perfecte hechting, speciaal ontwikkeld voor de schoenreparatie en de orthopedie.

Lijmt: rubber, leder, thermorubber, nylon, textiel, hout, enz. Koudlijmen bij ±20°C. Goed ruwen, afstoffen en beide zijden insmeren. Bij een te lange wachttijd kan men alsnog door activering zonder problemen perfect lijmen.

Rocket est une colle transparente, facile à enduire, avec une adhésion parfaite, spécialement développée pour l'orthopédie et la cordonnerie.

Colle: caoutchouc, cuir, caoutchouc TR, nylon, textile, bois, etc. Utiliser à froid à ±20°C. Carder à fond, dépolir et en-duire les deux côtés. En cas d'attente trop longue, le collage peut s'effectuer parfaitement après réactivation à chaud.



714

11,5kg

814

11,5kg

EXTRA FIX SLOW

transparenter Neopren-Kleber
transparent neoprene glue
transparante neopreenlijm
colle néoprène transparente

EXTRA FIX RAPID

transparenter Neopren-Kleber
transparent neoprene glue
transparante neopreenlijm
colle néoprène transparente

DAS UMWELTFREUNDLICHE MEHRWEGKANNEN-SYSTEM

- umweltfreundlich:* - keine Umweltverschmutzung durch leere Verpackungen und chemischen Abfall
sparsam: - keine Rückstände in der Kanne - bis zum letzten Tropfen verwertbar
Qualität: - der Klebstoff dickt durch Ventilregulierung nicht ein - immer einfach zu streichen
praktisch: - abfüllen war nie so praktisch
universell: - klebt alles ausser PVC

THE UNIQUE ECOLOGICAL SYSTEM WITH A RECYCLING PACKAGING

- ecological:* - no empty cans or chemical waste
economical: - no remainders in the can: usable until the last drop of glue
quality: - the glue can't get thicker in the can, thanks to the valvesystem
practical: - very practical to draw off with the unique tap
universal: - glues everything with exception of PVC

HET UNIEKE MILIEUVRIENDELIJKE SYSTEEM MET HERBRUIKBARE VERPAKKING

- milieuvriendelijk:* - geen lege bussen of chemisch afval meer
zuinig: - geen bodemresten: tot de laatste druppel bruikbaar
kwaliteit: - lijm kan niet indikken - blijft altijd vloeibaar tot de laatste druppel, dankzij het unieke ventielsysteem
praktisch: - gemakkelijk afvullen dankzij de unieke kraan
universeel: - lijmt alles met uitzondering van PVC

LE SYSTEME UNIQUE DE BIDONS ECOLOGIQUES ET RECYCLABLES

- écologique:* - plus de vidanges et restants chimiques à jeter
économique: - pas de dépôt: le bidon se vide jusqu'à la dernière goutte
qualité: - la colle reste toujours aussi liquide par le système de valve
pratique: - très pratique grâce à son robinet et système unique
universelle: - colle toutes matières, à l'exception de PVC

SLOW

OFFENE ZEIT
OPEN TIME
OPEN TIJD
TEMPS OUVERT

beim hammern:
by hammering:
bij hameren:
en martelant:
15-60 min.

beim pressen:
by pressing:
bij persen:
à la presse:
15-90 min.

RAPID

OFFENE ZEIT
OPEN TIME
OPEN TIJD
TEMPS OUVERT

beim hammern:
by hammering:
bij hameren:
en martelant:
3-30 min.

beim pressen:
by pressing:
bij persen:
à la presse:
3-45 min.

FIX 210.

1

TOLUOL FREE



		3	4
		EXTRA FIX SLOW	EXTRA FIX RAPID
		transparenter Neopren-Kleber transparent neoprene glue transparente neopreenlijm colle néoprène transparente	transparenter Neopren-Kleber transparent neoprene glue transparente neopreenlijm colle néoprène transparente
02	2kg	•	•
05	4kg	•	•
10	10kg	•	•

MIRACLE GLUE 20.

1

CYANOACRYLATE



	06	30	40
	V60	V300	FLEX
	2	5	5
	20 gr.	50 gr.	50 gr.
N/F	•	•	
D/E	•	•	
N/F/D/E		•	•

Ab 1000 Stück pro Sorte auch erhältlich mit eigenem Label.
As from 1000 pieces per type also available with your own label.
vanaf 1000 stuks per soort ook verkrijgbaar met eigen label.
A partir de 1000 pièces aussi en vente avec votre propre étiquette.

RESINFORM



Regal
rack
rek
étagère
6030000210

BAG-IN-BOX



revolutionär:

- praktisches Abfüllen
- Präzision beim Wiegen
- kein Schmutz, kein Schmierien

revolutionary:

- practical and fast
- easy to get a very precise weight
- no spilling

revolutionair:

- snel en superpraktisch
- precisie bij het wegen
- geen gemors

révolutionnaire:

- pratique et plus rapide
- facile à peser le poids exact
- pas de gaspillage

1. EXTRA RESINFORM

Leistenschaum
Resin for lasts
Leestenschuim
Résine pour formes



EXTRA BAG-IN-BOX

24100A	24100B
POLYOL	ISOCYANATE
10kg	10kg

100 cm ³	31 gr	31 gr
200 cm ³	62 gr	62 gr
400 cm ³	124 gr	124 gr
600 cm ³	186 gr	186 gr
800 cm ³	248 gr	248 gr
1000 cm ³	310 gr	310 gr
1200 cm ³	372 gr	372 gr
1400 cm ³	434 gr	434 gr
1600 cm ³	496 gr	496 gr

2. EXTRA RESINFORM

Leistenschaum
Resin for lasts
Leestenschuim
Résine pour formes

A - POLYOL	5kg	24005A
A - POLYOL	10kg	24010A
B - ISOCYANATE	5kg	24005B
B - ISOCYANATE	10kg	24010B



3. TS-Boy Sparbehälter
Economy glue container
Lijmpot
Réceptif économique

Small - 0,4l. **6078351000**

Ersatzpinsel/spare brush
vervangborstel/pinceaux remplaçant **6078351001**

Medium - 0,9l. **6078352000**

Ersatzpinsel/spare brush
vervangborstel/pinceaux remplaçant
rund/round/rond/rond **6078352001**
flach/flat/plat/plat **6078352002**

Large - 1,5l. **6078353000**

Ersatzpinsel/spare brush
vervangborstel/pinceaux remplaçant
nr 10 **6078353001**
nr 12 **6078353002**



4. **TRENNMITTEL**

5l.



24300

5. Mischbecher (25St.)
cup for mixing (25p.)
mengbeker (25st.)
gobelet pour mélanger (25p.)

small - 700 ml.
large - 2300 ml.



252007

252023

6. Ruhrstab Holz (5 St.)
stirring stick, wood (5 p.)
houten mengstokjes (5 stuk)
spatule en bois (5 p.)

25210



7. **FOOTPRINT**
Trittschaum (25St.)
footprint (25p.)
afdrukschuim (25st.)
boîte d'empreintes (25p.)

normal - 32 x 15 x 4 cm

7000

large - 34 x 17 x 5,5 cm

7000G



8. **FOOTDOC**
Druck sensitiv Papier, 100 sheets
pressure sensitive paper, 100 sheets
drukgevoelig papier, 100 vel
papier sensible pression, 100 sheets

79001



9. Orthoplaster 5 kg
+3 tubes hardener

260005



VERSCHIEDENES - VARIOUS - DIVERSE - DIVERS

1. **HOOCO** - 130g
 farbwachs
 triangle wax
 was driehoekig
 cire triangulaire

schwarz/black/zwart/noir 23500
 d.braun/d. brown/d.bruin/brun f. 23501
 farblos/colourless/kleurloos/incolore 23507
 m.braun/m. brown/m.bruin/brun m. 23511



4. **ACETON**
 Farblösemittel
 paint remover
 verfoplosser
 decapant

1l. 22101
 5l. 22105



2. **WACHS IT** - 1kg
 wachs tinte
 liquid wax
 wasinkt
 cire

schwarz/black/zwart/noir 2310
 braun/brown/bruin/brun 2311
 farblos/colourless/kleurloos/incolore 2317



5. **TOLUEEN**
 Kleberlösemittel
 glue solvent
 lijmoplosser
 dissolvant de colle

1l. 22201
 5l. 22205



3. **TOP FINISH** - 75ml
 in 16 Farben
 all 16 colours
 alle 16 kleuren
 toutes les 16 couleurs

238



100	009	011	005	007	035	054	046
colourless	white	nickle	light beige	sand	middle brown	smoke	dark brown
022	044	017	060	056	081	078	018
bison	schlamm	beige grey	light grey	stone grey	black	dark blue	bambus

Farbabweichungen zwischen dem Farbdruck und dem Originalprodukt sind möglich.
 Colour differences between print and original product are possible.
 Kleurverschillen tussen het drukwerk en het origineel produkt zijn mogelijk.
 Des différences de couleur entre l'imprimerie et la produit originale sont possible.



1. RENIA MULTI-COLLE
2120201 1l
2120204 4kg
2120210 10kg



2. RENIA COLLE DE COLOGNE
2120301 1l
2120304 4kg
2120310 10kg



3. RENIA FORTE
2120401 1l
2120410 10kg



4. RENIA TOP-FIT
2120508 8kg



5. RENIA KLEB-FEST
2120606 60g
2120609 90g



6. RENIA VULKOFEST
2120704 4kg
2120710 10kg



7. RENIA ORTEC
2120901 1l
2120904 4kg
2120910 10kg



8. RENIA GUMMILÖSUNG
2121000 580g
2121004 4kg



9. RENOL AL ANTISTATIC
21211006 640g
2121104 4kg



10. RENIA FIX
 KONKURRENZKLEBER
2121204 4kg
2121210 10kg



11. RENIA SYNTIC
2121500 90g
2121501 1l
2121504 4kg



12. RENOL 'ASTI'
2121600 640g
2121604 4kg



13. RENIA AQUILIM
2121703 Aquilim 130 - 3kg
2121803 Aquilim 315 - 3kg



14. RENIA SCHNELLKLEBER/
 VERDÜNNER
2122101 1l
2122105 5l
2122112 12l



15. RENIA DESOHL
2122201 1l
2122205 5l



16. RENIA PRIMER PUR
2122404 85ml
2122425 250ml



17. RENIA REHAGOL
2122504 85ml
2122525 250ml



18. RENIA PROTOCOLLE AKTIVATOR
21230200 200ml

LEDER
CUIR
LEDER
LEATHER



AFT[®]
AFT-International.com



5.01	BODENLEDER SOLE LEATHER ZOLLEDERS CUIRS À SEMELLES	5.2
5.02	BLANKLEDER VEGETAL TANNED LEATHER BLANKLEDERS CUIRS VÉGÉTAL	5.3
5.03	FUTTERLEDER LEATHER LINING VOERINGLEDERS CUIRS DOUBLURE	5.4
5.04	LEDERARTIKEL LEATHER PARTS LEDER ARTIKELEN ARTICLES EN CUIR	5.6

CROUPONS 311.

CROUPONS - BENDS - CROUPONS - CROUPONS

 Hals
neck
hals
collet

 croupon
croupon
croupon
croupon

 1/2 croupon
1/2 croupon
1/2 croupon
1/2 croupon

 Band
band
band
bande

 Rücken
back
rug
dosset

 1/2 Rücken
1/2 back
1/2 rug
1/2 dosset

 Flanke
side
flank
flanc

 Spitzenqualität, Naturprodukt, beste Wahl
Altgerbung - sehr abriebfest - flexibel

 first choice extraordinary quality
oaktanned - very strong - flexible

 Natuurprodukt in allerbeste kwaliteit
traag geloid - uiterst sterk - flexibel

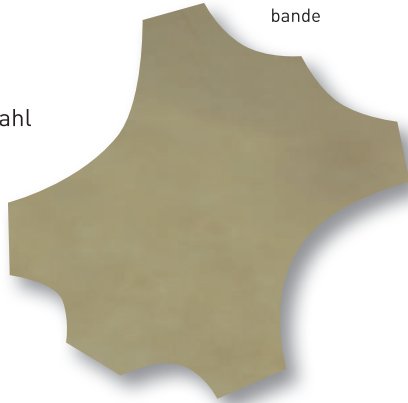
 1er choix qualité extraordinaire
tannage lent - très solide - flexible

2,5-3,0 mm

3,1 -3,5 mm

3,6-4,0 mm

4,1-4,5 mm

4,6-5,0 mm

5,1-5,5 mm

3112530**3113135****3113640****3114145****3114650****3115155**
CROUPONS 3241

kg.

STANZRESTE - CUTTING RESTS - AFVAL ASSORTIMENT - ASSORTIMENT DE DÉCHET
EXTRA 321.



10p.

SOHLEN - SOLES - ZOLEN - SEMELLES

> part 11.01

		1	2	3	7	4	5	6	8	9
		Damen-1 women-1 dames-1 dames-1	Damen-2 women-2 dames-2 dames-2	Damen-3 women-3 dames-3 dames-3	Damen-7 women-7 dames-7 dames-7	Herren-4 men-4 heren-4 hommes-4	Herren-5 men-5 heren-5 hommes-5	Herren-6 men-6 heren-6 hommes-6	Herren-8 men-8 heren-8 hommes-8	Herren-9 men-9 heren-9 hommes-9
20	2,0-2,5 mm.	•	•	•	•	•	•	•	•	•
25	2,5-3,0 mm.	•	•	•	•	•	•	•	•	•
31	3,1-3,5 mm.	•	•	•	•	•	•	•	•	•
36	3,6-4,0 mm.		•	•	•	•	•	•	•	•
41	4,1-4,5 mm.		•		•	•	•	•	•	•
46	4,6-5,0 mm.					•	•	•	•	•
51	5,1-5,5 mm.					•	•	•	•	•

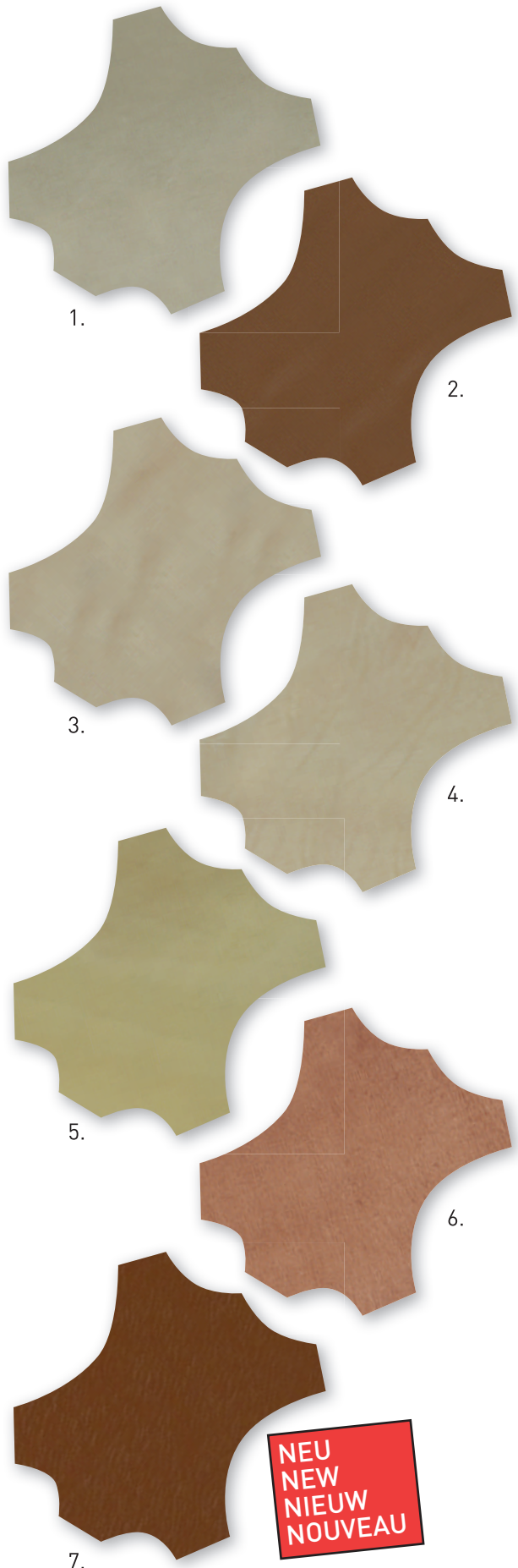
 Option: Auf Anfrage liefern wir Ihnen die Sohlen geschliffen und geprägt.
 option: If requested the soles can be delivered buffed and stamped.
 optie: De zolen kunnen gestempeld en geschuurd worden geleverd.
 option: Nous pouvons vous livrer les semelles cardées et estampées.

HÄLSE - NECKS - HALZEN - COLLETS

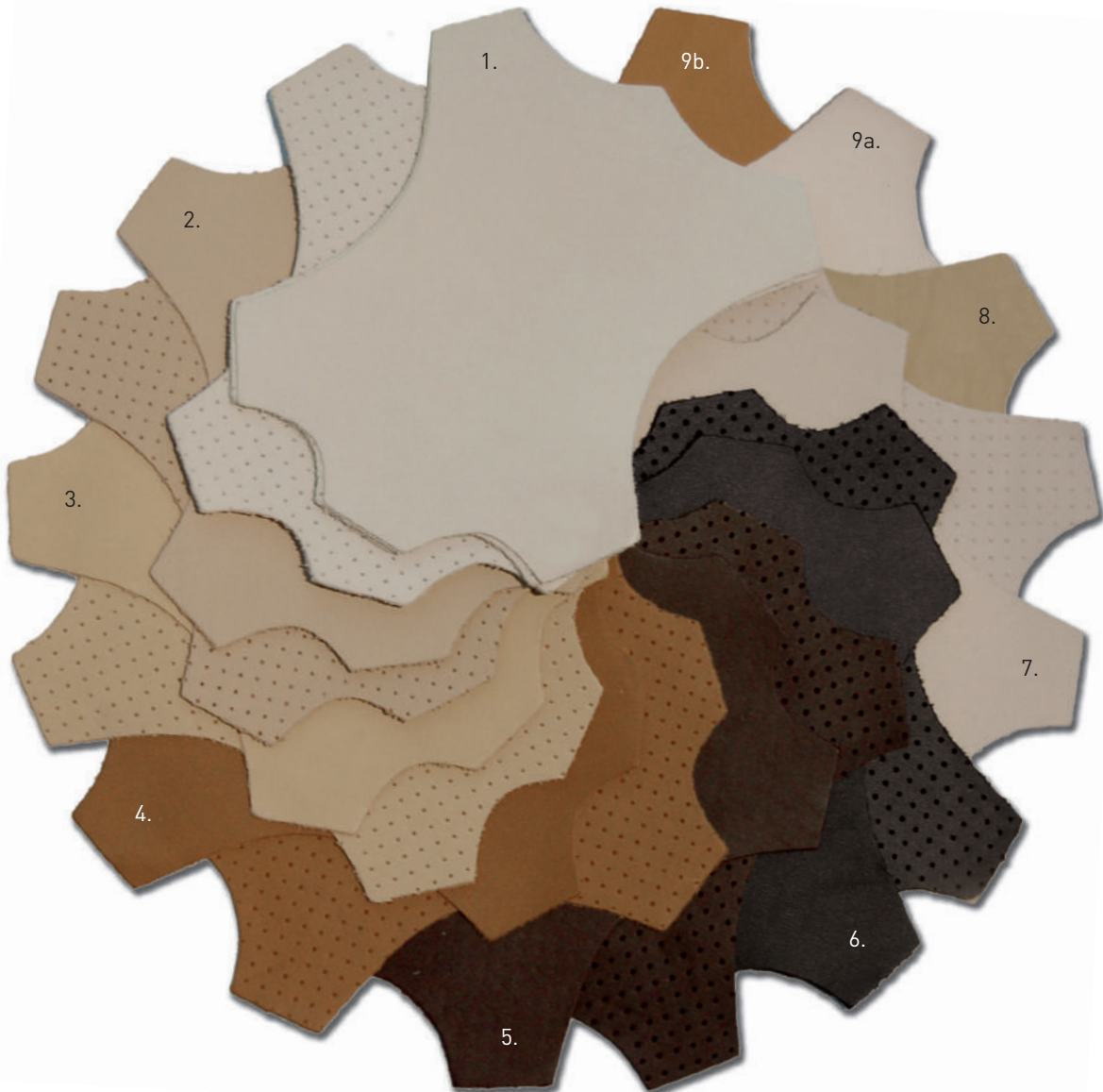

1. Spaltcroupon natur|Splitted bend natural|
Splitcroupon naturel|Croûte de croupon naturel
Für Brandsohlen und Basis für Einlagen
For insoles and base of orthotics.
Voor binnenzolen en basis van steunzolen
Pour semelles intercalaires et bases des semelles orthopédiques
0,80-1,00 mm **333008**
1,00-1,25 mm **333010**
1,25-1,50 mm **333012**
1,50-1,90 mm **333015**
2. Spaltleder zugerichtet|Splitleather pigmented|
Rundscroute gepigmenteerd|Croûte de vachette pigmentée
Basis für Einlagen, Einlegesohlen
Base for orthotics, insoles
Basis voor steunzolen, binnenzolen
Base des semelles orthopédiques, semelles intérieures
1,2-1,5 mm **333112**
3. **Ortho - Blanklederhals natur|Necks natural|**
Vormhals naturel|Collet à mouler naturel
Für Einlagen, Brandsohlen, Bandagen, Gürtel usw.
For orthotics, insoles, bandages, belts etc.
Voor steunzolen, binnenzolen, bandages, riemen etc.
Pour semelles orthopédiques, semelles intercalaires, bandages, ceintures etc.
1,2-1,4 mm **330012**
1,4-1,6 mm **330014**
1,8-2,0 mm **330018**
2,0-2,5 mm **330020**
2,5-3,0 mm **330025**
4. **Ortho - Hals|Neck|Hals|Collet**
Für Einlagen, Orthesen, Prothesen
For orthotics, orthosis, prothesis
Voor steunzolen, orthesen, prothesen
Pour semelles orthopédiques, orthèses, prothèses
2,5 mm **331225**
5. **Ortho - Rindlederhaut|Double bend|Dubbele rundscroupon|Croupon double**
Natur gegläntzt, 1. Wahl. Für Einlagen, Orthesen, Prothesen
Natural glazed, 1st Choice. For orthotics, orthosis, prothesis
Naturel glacé, 1ste keuze. Voor steunzolen, orthesen, prothesen
Naturel glacé, 1er choix. Pour semelles orthop., orthèses, prothèses
1,25-1,5 mm **33400**
6. **Altgerber - Hals für Kappen und Orthesen|Neck for counters and orthoses|**
Hals contreforten orthesen|Collet contrefort et ortheses
1,5-2,0 mm **33202**
2,0-2,5 mm **33203**
2,5-3,0 mm **33204**
7. **Podocuir - 95% Lederfaser Komposit|95% leather fibre compound|**
95% natuurlijke ledervezel-composiet|composé de 95% de fibres de cuir naturel
Abwaschbar, ständige Qualität und Stärke. Erträgt Transpiration.
Für Brandsohlen und Basis für Einlagen
Washable, permanent quality and thickness. Withstands transpiration.
For insoles and base of orthotics.
Afwasbaar, constante kwaliteit en dikte. Weerstaat transpiratie.
Voor binnenzolen en basis van steunzolen
Lavable, qualité et épaisseurs constantes. Résiste à la transpiration.
Pour semelles intercalaires et bases des semelles orthopédiques
1,1 mm - 100x140cm **335011**
1,4 mm - 100x140cm **335014**

**NEU
NEW
NIEUW
NOUVEAU**



Kombinationen von echtes Leder mit PPT
Combinations of real leather laminated with PPT
Combinaties van echt leder met PPT
Du vrais cuir laminé avec du PPT



 > part 1.41

Auch lieferbar in Sohlen  > part 11.01
Also available in soles
Ook verkrijgbaar in zolen
Aussi disponible en semelles découpées

- | | | |
|--|---|--|
| 1. creme/cream/crème/crème
0,6-0,8 mm <u>341006</u>
0,6-0,8 mm perfo <u>341006SP</u>
0,8-1,0 mm <u>341008</u>
0,8-1,0 mm perfo <u>341008SP</u>
1,0-2,0 mm <u>341010</u>
1,0-2,0 mm perfo <u>341010SP</u> | 4. cognac
0,8-1,0 mm <u>341608</u>
0,8-1,0 mm perfo <u>341608SP</u> | 8. safran
0,8-1,0 mm <u>342808</u> |
| 2. natural/natural/natuur/nature
0,8-1,0 mm <u>341208</u>
0,8-1,0 mm perfo <u>341208SP</u> | 5. braun/brown/bruin/brun
0,8-1,0 mm <u>341808</u>
0,8-1,0 mm perfo <u>341808SP</u> | 9. vegetal
0,8-1,0 mm cream <u>342506</u> |
| 3. camel
0,7-0,9 mm <u>341407</u>
0,7-0,9 mm perfo <u>341407SP</u> | 6. schwarz/black/zwart/noir
0,8-1,0 mm <u>341908</u>
0,8-1,0 mm perfo <u>341908SP</u> | 10. taupe - forest
0,8-1,0 mm <u>342208</u>
0,8-1,0 mm perfo <u>342208SP</u> |
| | 7. beige - Forest
0,8-1,0 mm <u>342008</u>
0,8-1,0 mm perfo <u>342008SP</u> | 11. nut
0,8-1,0 mm <u>342108</u>
0,8-1,0 mm perfo <u>342108SP</u> |

RIND - COW - RUND - BOVIN

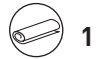

12. Extrem flexibele vollständige Fellen Leder, hautfarbe
Very flexible complete hide, skin colour
flexibele volledige grote vellen, huidskleur
Peaux complètes, très flexibles, couleur chair

0,6-0,7 mm **353106**

13. **Quality**

1,25 mm **353300**

1,25 mm perfo **353300P**

12.

13.

ZIEGEN/SCHAF - GOAT/SHEEP - GEIT/SCHAAP - CHÈVRE/BAZANE

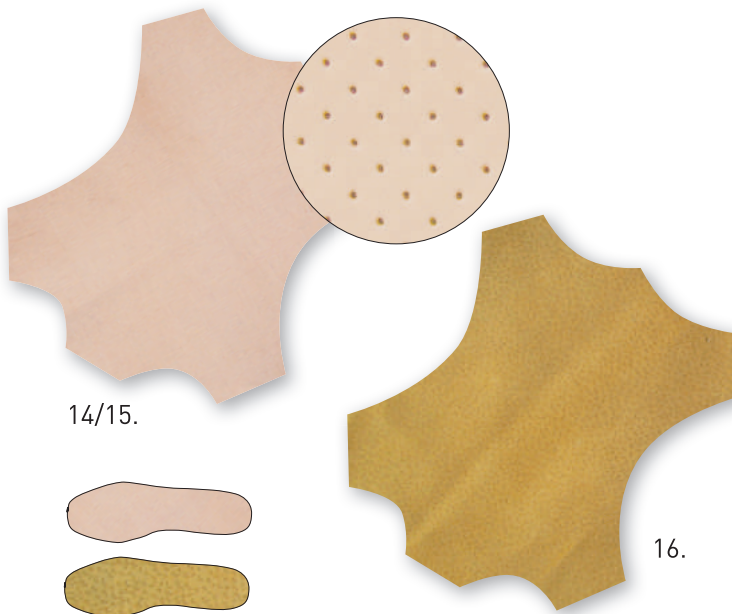
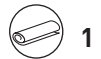

14. Ziegenfutter blond natur
Goatlining blond natural
Geitenvoering blond naturel
Chèvre doublure blonde naturel

0,6 - 0,8 mm **3550**

0,6 - 0,8 mm perfo **3550P**

15. Skiver beige

0,5 mm **3552**

16. Schaffutterleder mit Peccari-Narben

Sheeplining peccari print

Bazaan peccariprint

Bazane grain de peccari

3553213

14/15.

16.

SCHWEIN - PORC - VARKEN - PORC

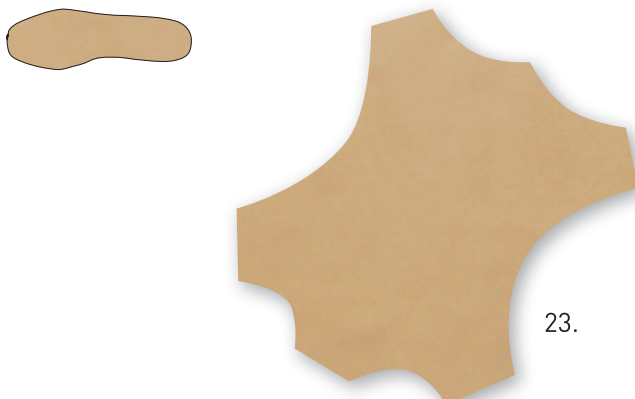

23. spalt velouté
split velouté
croute velouté
croute velouté

355400

23.

5.04

LEDERARTIKEL
LEATHER PARTS
LEDER ARTIKELEN
ARTICLES EN CUIR

EINLEGESOHLE 5139.



12p.

EINLEGESOHLE - INSOLE - INPLAKZOOŁ - SEMELLE À COLLER EN CUIR



Leder leather leder cuir		36 > 48
<input type="checkbox"/>	schwarz black zwart noir	•
9	Farbe sortiert assorted colours kleurassortiment coloris assortis	•

FUTTER 360.



25p.

FERSENFUTTER - BACKLINING - HIELVOERING - DOUBLURE DE TALON



		1	2	3	4
		Damen women dames dames	Herren men heren hommes	Herren XL men XL heren XL hommes XL	Stiefel boot laars botte
<input type="checkbox"/>	schwarz black zwart noir		•	•	
1	crust crust crust crust	•		•	
6	Farbe sortiert assorted colours kleurassortiment coloris assortis		•	•	•

RIESTER 3605

150

RIESTER GESCHÄRFT - INSERTS SKIVED - LIJMLAPJES GESCHALMD - CACHE DÉCHIRURE ROGNÉE



Farbe sortiert
assorted colours
kleurassortiment
coloris assortis

GRIFFE



GRIFFE - HANDLES - HANDVATTEN - POIGNÉES



in 3 Farben.
all 3 colours.
alle 3 kleuren.
toutes les 3 couleurs.

1. Leder/leather/leder/cuir
36344
2. Leder/leather/leder/cuir
36346
3. Leder/leather/leder/cuir
363487
4. Skai/imitation leather/skai/skai
363511
5. Leder/leather/leder/cuir
363520
6. Skai/imitation leather/skai/skai
363551
7. Leder/leather/leder/cuir
363562

GRIFFE 363.



GRIFFE - HANDLES - HANDVATTEN - POIGNÉES



in 7 Farben
all 7 colours
alle 7 kleuren
toutes les 7 couleurs

1 Wulsthenkel 50cm.
cording strap 50cm.
marktts 50cm.
bourrelet 50cm.



LEDER/LEATHER/LEDER/CAIR

00	01	11	03	04	05	06
schwarz black zwart noir	dunkelbraun dark brown donkerbruin brun foncé	mittelbraun medium brown middelbruin brun moyen	cognac brandy cognac cognac	beige beige beige beige	dunkelblau dark blue donkerblauw bleu foncé	weiß white wit blanc

Farbabweichungen zwischen dem Farbdruck und dem Originalprodukt sind möglich.
Colour differences between print and original product are possible.
Kleurverschillen tussen het drukwerk en het origineel product zijn mogelijk.
Des différences de couleur entre l'imprimerie et la produit originale sont possible.

WERKSTATTEINRICHTUNGEN
WORK SHOP FURNISHINGS
WERKPLAATSINRICHTING
ÉQUIPEMENT D'ATELIER



AFT[®]
AFT-International.com



6

AFT INTERNATIONAL | GERMANY



MASCHINEN
MACHINERY
MACHINES
MACHINES



AFT[®]
AFT-International.com

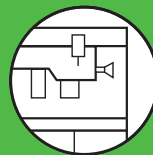

7

AFT INTERNATIONAL | GERMANY



**EINZELHANDEL
RETAIL
WEDERVERKOOP
ARTICLES DE REVENTE**

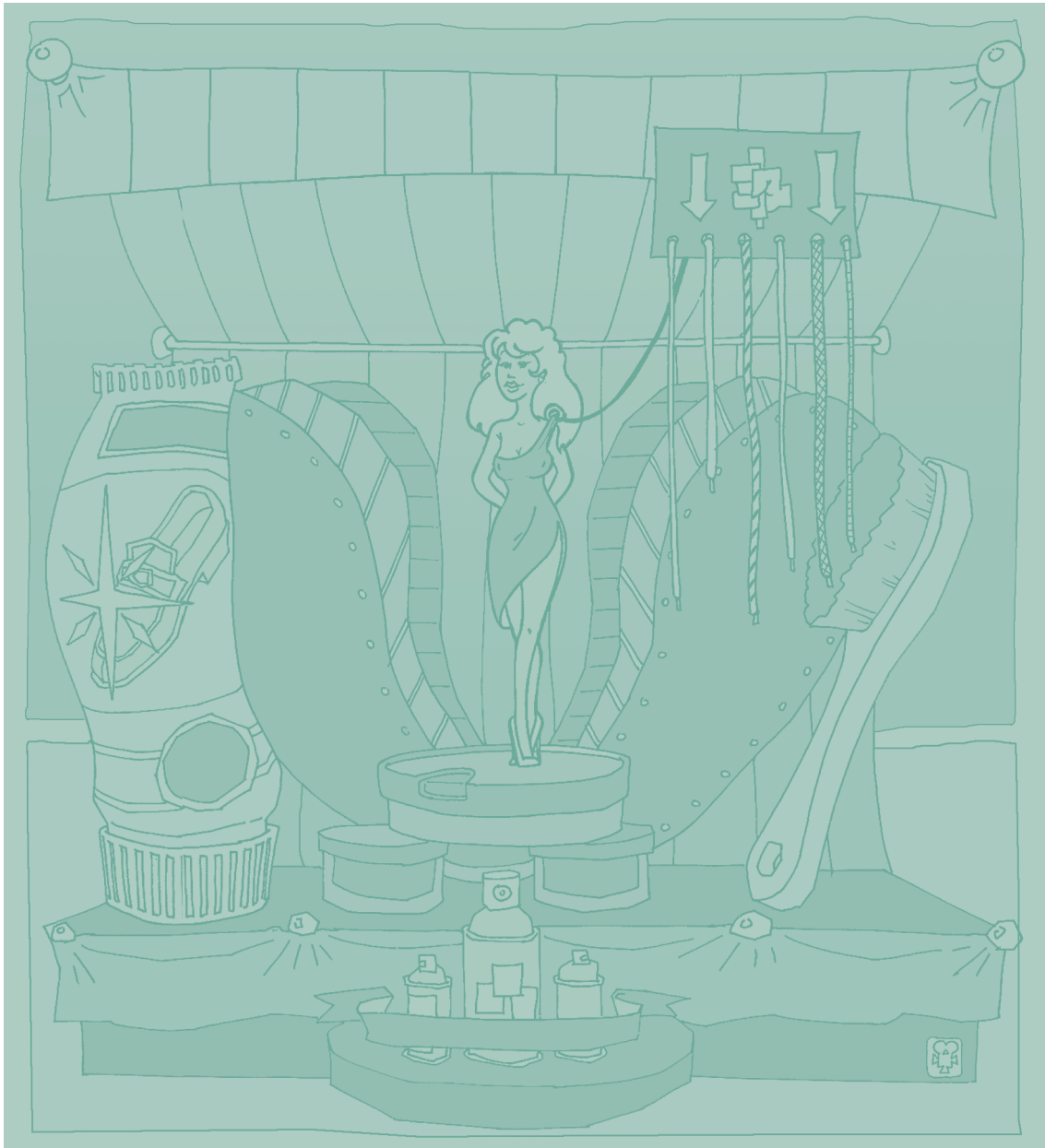

AFT[®]
AFT-International.com



8.01	SCHNÜRSENKEL LACES VETERS LACETS	8.2
8.02	EINLEGESOHLN INSOLES INLEGZOLEN SEMELLES INTERIEURES	8.10
8.03	SCHUHPFLEGEMITTEL SHOE CARE ONDERHOUDSPRODUCTEN PRODUITS D'ENTRETIEN	8.18
8.04	FURNITUREN SHOE ACCESSORIES SCHOENACCESSOIRES ACCESSOIRES CHAUSSURES	8.26

8.01

SCHNÜRSENKEL LACES VETERS LACETS

571024.



10 oder
of
ou 20P.

rund-dünn
round-thin
rond-dun
rond-fin
Ø2mm

auch auf Rolle/ also on roll/ook op rol/également sur rouleau 200m >8.8

		5								
		045	060	075	090	100	120	150	180	200
		45cm	60cm	75cm	90cm	100cm	120cm	150cm	180cm	200cm
	001	20	20	20	20		20	10	10	
	120		10	10	10					
	231		10	10	10					
	271		10	10	10					
	360		10	10						
	380		10	10	10					
	506	20	20	20	20		20	10	10	
	508		10	10	10					
	571			10						
	590		10	10	10		10			
	602		10	10	10					
	817	10	10	10	10		10			



571270.



10 oder
of
ou 20P.

rund-dünn / WAX
round-thin / WAX
rond-dun / WAX
rond-fin / WAX

		5								
		045	060	075	090	100	120	150	180	200
		45cm	60cm	75cm	90cm	100cm	120cm	150cm	180cm	200cm
	001			20	20					
	506			20	20					
	571			20	20					

BOB-SL

rund/round/rond/rond

571428.



10 oder
or
of
ou 20P.

rund-dick
round-thick
rond-dik
rond-large
Ø4mm

auch auf Rolle/ also on roll/ook op rol/également sur rouleau 200m >8.8

		5								
		045	060	075	090	100	120	150	180	200
		45cm	60cm	75cm	90cm	100cm	120cm	150cm	180cm	200cm
		2	3	4	5	5	6	8	10	12
	001		20	20	10		10	10	10	10
	120			10	10		10	10		
	231			10	10		10	10		
	269		10		10		10	10	10	
	360				10		10	10		
	380			10	10		10	10		
	506		20	20	10		10	10	10	10
	571			10	10					
	664			10	10		10	10	10	
	817			10	10		10	10		
	976			10	10					

571449.



10 oder
or
of
ou 20P.

rund-dick / WAX
round-thick / WAX
rond-dik / WAX
rond-large / WAX

auch auf Rolle/ also on roll/ook op rol/également sur rouleau 200m >8.8

		5								
		045	060	075	090	100	120	150	180	200
		45cm	60cm	75cm	90cm	100cm	120cm	150cm	180cm	200cm
		2	3	4	5	5	6	8	10	12
	001			10	10		10			
	506			10	10		10			

BOB

001	380	360	120	278	269	231	271	276
black	dark grey	light grey	wit	gebroken wit	marmer	light beige	dark beige	dark taupe
322	506	508	571	590	602	664	976	817
light taupe	d. brown	very d. brown	cognac	m. brown	bordeaux	red	olive green	d.bleu

Farbabweichungen zwischen dem Farbdruck und dem Originalprodukt sind möglich.
Colour differences between print and original product are possible.
Kleurverschillen tussen het drukwerk en het origineel product zijn mogelijk.
Des différences de couleur entre l'imprimerie et la produit originale sont possible.

8.01

SCHNÜRSENKEL
LACES
VETERS
LACETS

571662.



10 oder
or
of
20P.
ou

rund / SPORT
round / SPORT
rond / SPORT
rond / SPORT
Ø3mm

auch auf Rolle/ also on roll/ook op rol/également sur rouleau 200m >8.8

		5								
		045	060	075	090	100	120	150	180	200
		45cm	60cm	75cm	90cm	100cm	120cm	150cm	180cm	200cm
		2	3	4	5	5	6	8	10	12
	001	20	20	20	20		10	10		
	120		10	10	10		10			
	231		10	10	10		10			
	271	10	10	10	10		10			
	276		10	10	10		10			
	278		10	10	10					
	322		10	10	10		10	10		
	360		10	10	10		10			
	380		10	10	10		10			
	506	20	20	20	20		10	10		
	508		10	10	10		10			
	571		10	10	10		10	10		
	590		10	10	10		10	10		
	602		10	10	10		10			
	664		10	10	10					
	817		10	10	10		10	10		

571219.



10 oder
or
of
20P.
ou

rund / WAX
round / WAX
rond / WAX
rond / WAX

auch auf Rolle/ also on roll/ook op rol/également sur rouleau 200m >8.8

		5								
		045	060	075	090	100	120	150	180	200
		45cm	60cm	75cm	90cm	100cm	120cm	150cm	180cm	200cm
		2	3	4	5	5	6	8	10	12
	001		20	20	20		10	10	10	
	506		20	20	20		10	10	10	
	571		10							
	602			10	10		10			
	817		10	10			10			

57



10P.

Trecking - rond
Trecking - round
Bergveters - rond
Lacets de marche - rond

			5							
			5							
			060	075	090	100	120	150	180	
			60cm	75cm	90cm	100cm	120cm	150cm	180cm	
	1484	026			10		10	10		
	1107	054			10		10	10	10	
	1278	045		10	10		10	10		

			5							
			5							
			060	075	090	100	120	150	180	
			60cm	75cm	90cm	100cm	120cm	150cm	180cm	
	1525	204			10		10	10		
		205			10		10	10		
		206			10		10	10		

			5							
			5							
			060	075	090	100	120	150	180	
			60cm	75cm	90cm	100cm	120cm	150cm	180cm	
	1475	006						10	10	
		071		10	10		10	10	10	
		072		10	10		10	10	10	
		073		10	10		10	10	10	
		001					10			
		590					10			

Farbabweichungen zwischen dem Farbdruck und dem Originalprodukt sind möglich.
Colour differences between print and original product are possible.
Kleurverschillen tussen het drukwerk en het origineel product zijn mogelijk.
Des différences de couleur entre l'imprimerie et la produit originale sont possible.



8.01

SCHNÜRSENKEL
LACES
VETERS
LACETS

571147.



10
oder
or
of
ou
20P.

flach
flat
plat
plat
9mm



	045	060	075	090	100	120
	45cm	60cm	75cm	90cm	100cm	120cm
	2	3	4	5	5	6

	001	20	20	20	20	20	
	120*		10	10	10	10	
	231		10	10	10		10
	271		10	10	10		10
	276		10	10	10		10
	278			10	10		10
	322			10	10		10
	360		10	10	10		10
	380	20	10	10	10	20	10
	506		20	20	20		10
	508			10	10		10
	571		10	10	10		10
	590		10	10	10		10
	602		10	10			
	664		10	10	10		10
	817		10	10	10		10
	976				10		10

571791.

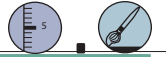

	120	150	180	200
	120cm	150cm	180cm	200cm
	6	8	10	12

	10	10	10	10
	10	10	10	10
		10		
		10		
		10		
		10		
		10		
		10		
		10		
				10
		10		

*auch auf Rolle/ also on roll/ook op rol/également sur rouleau 200m >8.8





Farbabweichungen zwischen dem Farbdruck und dem Originalprodukt sind möglich.
Colour differences between print and original product are possible.
Kleurverschillen tussen het drukwerk en het origineel product zijn mogelijk.
Des différences de couleur entre l'imprimerie et la produit originale sont possible.

BOB-SL

flach/flat/plat/plat



571250.

flach / WAX
flat / WAX
plat / WAX
plat / WAX

	075	090
	75cm	90cm
	4	5
	001	20
	506	20
	571	10



571431.

flach-Nylon
flat-nylon
plat-nylon
plat-nylon

	100	120
	100cm	120cm
	5	6
	001	20
	506	10



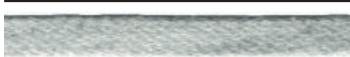

571145.

flach / VINTAGE
flat / VINTAGE
plat / VINTAGE
plat / VINTAGE

	120
	120cm
	6
	183
	180
	177

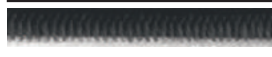



571675.

flach - elastisch
flat - elastic
plat - elastisch
plat - élastique

	060	090
	60cm	90cm
	3	5
	001	10
	231	10
	506	10
	817	10

571133.

Trecking - flach
Trecking - flat
Bergveters - plat
Lacets de marche - plat

	120	150	180
	120cm	150cm	180cm
	6	8	10
	050	10	10
	072	10	10
	076	10	10
	077	10	10

10
oder
of
of
ou



575.



1

200 m auf Rolle
200 m on roll
200 m op rol
200 m sur rouleau



024	662	428	147
Ø2mm	Ø3mm	Ø4mm SPORT	9mm



001	●	●	●	●
120	●	●	●	●
231	●	●	●	●
271	●	●	●	●
276	●	●	●	●
278	●	●	●	●
322				
360	●	●	●	●
380	●	●	●	●
506	●	●	●	●
508				
571	●	●	●	●
590	●	●	●	●
602	●	●	●	●
620	●	●	●	●
664			●	
817	●	●	●	●

**BOB FASHION**

assortment Dose 32 Paar
assorted box 32 pair
assortiment doos 32 paar
assortiment boîte 32 paires

57232060 60 cm

57232075 75 cm

57232090 90 cm



BOB DISPLAY - 270 REFS.

Display in Metal
 Display in metal
 Verkoopsstand in metaal
 Présentoir en métal

Leer/empty/leeg/vide

5991270

BOB DISPLAY - 32 REFS.

Display in Holz
 Display in wood
 Verkoopsstand in hout
 Présentoir en bois

Leer/empty/leeg/vide

5991032



5200.

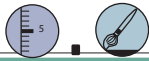

1 Blister

LEDER - LEATHER - LEDER - CUIR

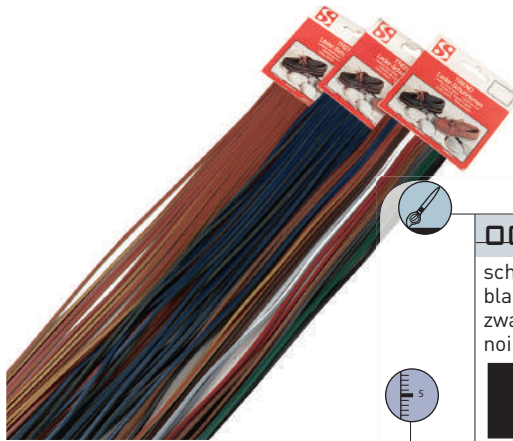

	00	01	03	05	08	09
	schwarz black zwart noir	d.braun d. brown d.bruin brun f.	natural natural naturel naturel	blau blue blauw bleu		assorted
Dockside 120cm	Karte 10 Paar card 10 pair kaart 10 paar carte 10 paires	•	•	•	• 	•
dünn thin dun fin 100cm	Karte 15 Paar card 15 pair kaart 15 paar carte 15 paires	•	•	•	• 	•



NATUREL - LEATHER

 1p.



1. NATUREL - SL106

Hochwertiges Leder mit Aktivkohle
 Leather with active carbon
 Leder met actieve koolstof
 Cuir à carbone actif

50041.

 36 > 48

2. NATUREL 1/2 - SL105

Hochwertiges Leder mit Aktivkohle 35/36 = 01
 Leather with active carbon 37/38 = 02
 Leder met actieve koolstof 39/40 = 03
 Cuir à carbone actif 41/42 = 04

50042.

43/44 = 05

3. 1/2 LEDER - SL2150

1/2 Leder Vorfusseinlage für schmale Füße
 1/2 Leather inlay for slender feet
 1/2 Leder voorvoetzool voor smalle voeten
 1/2 Cuir semelle pour pied étroit

50044.

00 > 03

4.. LEDER/LATEX - SL153

Leder/Latex - auch für Kinder
 Leather/Latex - also for kids
 Leder/Latex opvulzool - ook voor kinderen
 Cuir/Latex - aussi pour enfants

50043.

20/21 > 45/46, 47, 48, 49

KIDS

 1p.



5. LEDER KIDS - SL1211

Leder - Kinder
 Leather - kids
 Leder - kinderen
 Cuir - enfants

50049.

24/25 > 34/35

(4.) LEDER/LATEX KIDS - SL153

50043.

20/21 > 34/35

(8.) TOWEL KIDS - SL2000

50015.

23 > 35

6. **SANA - SL114**

Lederfaser (3 Paar)
Leatherfibre (3 pair)
Ledervezel (3 paar)
Fibre de cuir (3 paires)

50011.

35/36 > 45/46

7. **LATEX - SL1060**

Weicher und bequemer Latexschaum
Soft and comfortable Latex foam
Zacht en comfortabel schuimrubber
Mousse de latex, douce et confortable

50012.

35/36 > 45/46

8. **TOWEL - SL2000**

Badestoff, weiß - auch für Kinder
Towelling cotton, white - also for kids
Badstof, wit - ook voor kinderen
Tissu en éponge, blanc - aussi pour enfants

50015.

23 > 48

9. **KOKOS - SL5000**

Badestoff + Kokos, schwarz
Towelling cotton + coco, black
Badstof + kokos, zwart
Tissu en éponge + coco, noir

50016.

36 > 48

10. **DEO - SL6000**

Bezugstoff mit Aktivkohle auf latex Unterschicht
Textile with active carbon on a latex base
Textiel met actieve koolstof op latex onderlaag
Tissus avec carbone actif sur base en latex

50018.

36 > 47



WINTER - HIVERS

 1p.



11. **WINTER - SL1061**

Wolle (Synthetisch)
 Wool (synthetic)
 Vacht (synthetisch)
 Laine (synthétique)

50031.

 35/36 > 45/46

12. **MERINO - SL1062**

Merino Wolle mit Aktivkohle
 Lambswool with active carbon
 Lamswol met actieve koolstof
 Agneline avec carbone actif

50032.

36 > 48

13. **THERMO ALU-FLEECE - SL1064**

Aluminiumfolie + Fleece
 Aluminium foil + Fleece
 Aluminiumfolie + Fleece
 Papier alu + Fleece

50034.

36 > 48

LUXURY COMFORT

1. VIDA COMFORT

Anatomisches Fussbett aus Leder, Rückseite mit Aktivkohle zur Verminderung lästigen Fussgeruchs.

Anatomical formed sole in leather, with a charcoal layer for odour absorption.

Anatomsich gevormd voetbed uit leder, met een anti-bacteriële koolstoflaag tegen voetgeur.

Semelle anatomique en cuir, sur une sous-couche de charbon actif neutralisant l'odeur des pieds.

50001.

 36 > 48



3. OLYMPIC SPORT

Memory-Latex, ideal für Sport-, Wander- und Freizeitschuhe.

Soft microfiber velour with memory-latex, ideal for sport- walking and casual shoes.

Zacht microvezel velours met memory-latex, ideaal voor sport- wandel en vrijetijdsschoenen.

Doux velours de microfibre avec latex de mémoire, idéal pour des chaussures de sport, marche et occasionnelles.

50020.

 36 > 48

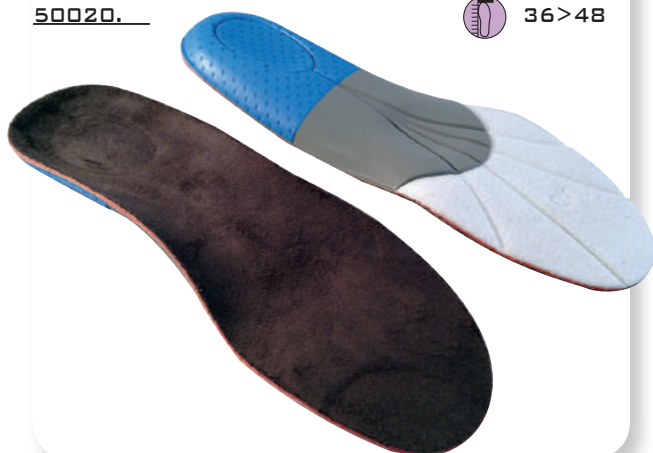

2. PEARL BIO

Einlage beschichtet mit hochwertiges Leder, elastischer Kern mit Latex Stoßdämpfung und Aktivkohle.

Inlay with high-quality leather, flexible centre with latex shock absorbing intermediate layer and active carbon.

Bovenmateriaal in zeer kwaliteitsvol leder, flexibel verstevigingskern met latex schokdemping en koolstof.

Semelle en cuir d'haute qualité, avec une intercalaire flexible avec une couche qui absorbe les chocs et du charbon actif.

50002.

 36 > 48





1. **1/2 LEDER + PELOTTE - SL10105** 
 1/2 Leder mit Vorfusspelotte
 1/2 Leather with pad
 1/2 Leder met voorvoetsteun
 1/2 cuir avec pelotte
 35/36 = 01
 37/38 = 02
 39/40 = 03
 41/42 = 04
50040.
2. **SL156**
 Einlage, hart
 Arch support, hard
 Steunzool, hard
 Semelle support, dur
 D36>D42
 H40>H48
50045.
3. **SL160**
 Damen vorfuss Stütze Leder
 Ladies forfoot support leather
 Dames voorvoetsteun leder
 Dames support cuir
 36>42
50047.
4. **SL7156**
 Fersenkissen, hart
 Heelcushion, hard
 Hielkussen, hard
 Talonnette, dur
 35/37 = 01
 38/40 = 02
 41/43 = 03
 44/46 = 04
50060.
5. **SL601**
 Fersenkissen, weich
 Heelcushion, soft
 Hielkussen, zacht
 Talonnette, douce
 35/37 = 01
 38/40 = 02
 41/43 = 03
 44/46 = 04
50061.
6. **SL**
 Fersenkissen Fersenspur
 Heelcushion heel spur
 Hielkussen hielspoor
 Talonnette epine calcané
 35/37 = 01
 38/40 = 02
 41/43 = 03
 44/46 = 04
50062.
7. **SL**
 Fersenkissen, Kork
 Heelcushion, cork
 Hielverhoger, kurk
 Talonnette, liège
 D05 = Dames 5mm (nr1)
 D07 = Dames 7mm (nr2)
 D10 = Dames 10mm (nr3)
 H05 = Heren 5mm (nr4)
 H07 = Heren 7mm (nr5)
 H10 = Heren 10mm (nr6)
50063.
8. **SL201**
 Rutschbremse
 Foot break
 Antislip
 Arrête-glisse
 Jede Größe
 all sizes
 alle maten
 toutes les pointures
50069.



9. **SL500**
T-Form mit Lederbezug
T-shaped with leather
Pelot T-vorm met lederbekleding
Pelotte forme T recouvert de cuir
50066.  01>04
10. **SL700**
Tropfen-Form mit Lederbezug
Drop-shaped with leather
Druppelvorm met lederbekleding
Forme-goutte recouvert de cuir
50067. 01>04
11. **SL112**
Gelenkstütze Leder
Footarch leather
Gelengsteun leder
Support cuir
50068. 00>03
12. **FRESCO SILICONEN**
Fersenkissen, zentrisch
Heelcushion, centric
Hielkussen, centrisch
Talonnette, centre
50080. 01>03
13. **FRESCO SILICONEN**
Fersenkissen, lateral
Heelcushion, lateral
Hielkussen, lateraal
Talonnette, lateral
50081. 01>03
14. **FRESCO SILICONEN**
Einlegesohlen
Insoles
Inlegzolen
Semelles interieures
50085. 35/36>45/46
15. **DERAMED HEEL GEL SLEEVE**
Elastische Socke mit Gel Fersenkissen
Toe less elastic sock with heel gel cushion
Teen loze elastische sok met hiel gel kussen
Chaussette élastique avec talonnette en gel
5008600

GEL

 1p.

1. **GEL HEEL**
 grün
 green
 groen
 vert
560509.

2. **GEL STEP**
 rosa
 rose
 roze
 rose
560505.

3. **GEL COMFORT**
 oranjen
 orange
 oranje
 orange
560507.

4. **EASY TEC**
 lila
 lila
 lila
 lila
560511. 36/37 > 40/42

5. **EASY STEP**
 rot
 red
 rood
 rouge
560503.

6. **GEL SLIP STOP**
 gelb
 yellow
 geel
 jaune
560501.

7. **DISPLAY EASY GEL**
 Leer
 Empty
 Leeg
 vide
560500

EVOLUTION

 1p.

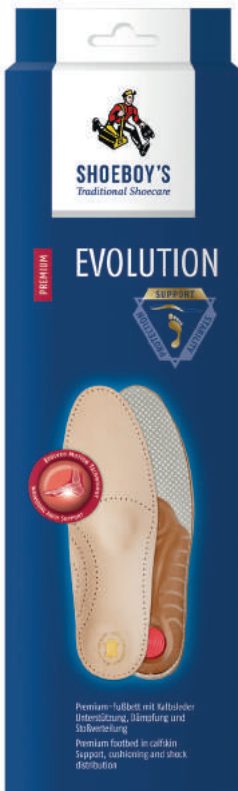

7. EVOLUTION SUPPORT



Unterstützung für Hohlfuss
Support for high arch foot
Ondersteuning voor holvoet
Support pour pied creux

56011.

36>48



8. EVOLUTION PROTECTION



Schutz für Normalfuss
Protection for normal foot
Bescherming voor gemiddelde/normale voeten
Protection pour pied normal

56012.

36>48

9. EVOLUTION STABILITY



Stabilität für Flatfuss, Senkfuss und Knickfuss
Stability for flat food and pes valgus
Stabiliteit voor plat-, knik en spreidvoeten
Stabilité pour pieds plat et pes valgus

56013.

36>48

10. EVOLUTION EMT SYSTEM

Maßsystem auf Basis von Druck und Wärme
Pressure measurement system based on Warmth
Drukmeetsysteem met behulp van druk en warmte
Système de mesure de la pression basé sur la chaleur

560100

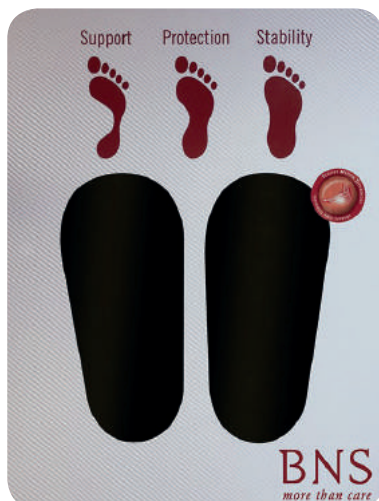
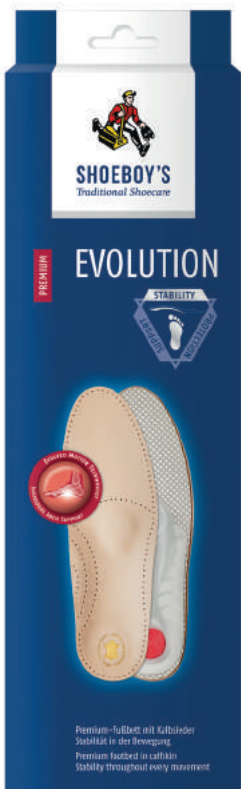



1.

2.

3.

1. **LEATHER BALM**, 100 ml
55150

LEATHER BALM DISPLAY, 24 St./pc/st./pc
5515024

2. **LEATHER WAX**, spray 200 ml
55170 Farblos/neutral/kleurloos/neutre

3. **LEATHER CREAM**, 75 ml
55060.

21 Farben/colours/kleuren/couleurs:
01, 02, 06, 10, 13, 14, 25, 32,
37, 38, 40, 42, 47, 54, 55, 56,
57, 58, 60, 66, 67



4.

5.

6.

7.

4. **PATENT LEATHER CARE**, spray 150 ml
55500

5. **PATENT LACK LEATHER**, stick 75 ml
55370

6. **VELOUR NUBUCK CARE**, stick 75 ml
55200.

9 Farben/colours/kleuren/couleurs:
01, 10, 23, 25, 27
32, 40, 42, 47

7. **VELOUR NUBUCK CARE**, spray 200 ml
55250.

5 Farben/colours/kleuren/couleurs:
01, 23, 40, 42, 47



8.

8. **VELOUR NUBUCK BLOCK**, 12 St./pc/st./pc
55620



9.

10.

11.

9. **COMBI CARE**, spray 200 ml
55320

10. **NANO PROTECT**, spray 400 ml
55300

11. **WATER PROTECT**, spray 200 ml
55302



12.

13.



14.



15.



16.



17.



18.



19.

12. **MULTI COLOR**, 75 ml
55080

13. **RUSTIC CREAM**, 75 ml
55100

14. **SHOE CREAM**, 50 ml
55010

30 Farben/colours/kleuren/couleurs:

01, 03, 04, 05, 11, 13, 23, 25,
33, 35, 38, 40, 42, 44, 46, 47,
51, 55, 60, 61, 62, 81, 82, 83,
84, 85, 86, 87, 88, 89, 90, 91,
92, 93, 94, 95, 96, 97

15. **DELICATE GEL**, 50 ml
55030

16. **SHOE SHINE**, 10 St./pc/st./pc
Schwamm, neutral
Sponge, neutral
Spons, neutraal
Eponge, neutrale
55600

17. **PURE WHITE**, 75 ml
55120

18. **SHOE FRESH**, spray 100 ml
55400

19. **ACTIVE FRESH**, spray 100 ml
55410

20. **SHOE STRETCH**, 125 ml
55540

21. **METALLIC FASHION**, 150 ml
55450

22. **CLEANING CLOTH**, 75 ml
55630



20.



21.



22.



Farbe: siehe Farbkarte, nächste Seite
colour: see colour chart next page
kleur: zie staalkaart op volgende pagina
couleur: voir carte de couleurs, page suivante

**DISPLAY
SHOE CREAM, 50 ml**

Leer/empty/leeg/vide

5991324



	FARBBEZEICHNUNG	LEATHER CREAM 75 ml	EXCLUSIVE CARE 100 ml	SHOE CREAM 50 ml	VELOUR NUBUCK CARE 75 ml
	1 Farblos <i>colourless</i>	907648	1103308	990059	907658
	60 Deckweiss <i>opaque white</i>	906562	-	990270	-
	2 Pflegeweiß <i>white</i>	908313	-	-	-
	94 Creme <i>cream</i>	-	-	990275	-
	3 Off White <i>off white</i>	-	-	990281	-
	4 Wollweiss <i>wool</i>	-	-	990273	-
	5 Eierschale <i>ivory</i>	-	-	990278	-
	6 Beige <i>beige</i>	906883	-	-	-
	32 Taupe <i>taupe</i>	901285	-	-	901286
	90 Sinai <i>sinai</i>	-	-	990265	-
	35 Gabardine <i>gabardine</i>	-	-	990060	-
	92 Dunkelbeige <i>dark beige</i>	-	-	990271	-
	37 Bast <i>tan</i>	906590	-	-	-
	54 Camel <i>camel</i>	907657	-	-	-
	55 Havanna <i>havana</i>	906591	-	990257	-
	38 Hellbraun <i>light brown</i>	907652	-	990250	-
	81 Cognac <i>cognac</i>	-	-	990070	-
	83 Canyon <i>canyon</i>	-	-	990251	-





	FARBBEZEICHNUNG
	85 Goldbraun <i>golden brown</i>
	40 Mittelbraun <i>middle brown</i>
	51 Coca <i>coca</i>
	88 Hasel <i>hazel</i>
	89 Greige <i>greige</i>
	42 Dunkelbraun <i>dark brown</i>
	93 Mustard <i>mustard</i>
	57 Orange <i>orange</i>
	82 Karamel <i>caramel</i>
	10 Rot <i>red</i>
	11 Kirsche <i>cherry</i>
	91 Ziegel <i>brick</i>
	13 Bordeaux <i>bordeaux</i>
	87 Mahagoni <i>mahogany</i>
	14 Zartrosa <i>light pink</i>
	66 Lila <i>purple</i>
	56 Hellblau <i>light blue</i>
	84 Kobaltblau <i>cobalt blue</i>

SHOE BOY'S

FARBKARTE - COLOR CHART - KLEURENKAART - CHARTE DE COULEURS



55901

 LEATHER CREAM 75 ml	 EXCLUSIVE CARE 100 ml	 SHOE CREAM 50 ml	 VELOUR NUBUCK CARE 75 ml
-	-	990258	-
907653	1103311	990062	907671
-	-	990252	-
-	-	990261	-
-	-	990264	-
907654	1103312	990063	906910
-	-	990272	-
906889	-	-	-
-	-	990061	-
907656	-	-	907669
-	-	990256	-
-	-	990269	-
907655	903310	990058	-
-	-	990260	-
906884	-	-	-
909693	-	-	-
907659	-	-	-
-	-	990255	-

	FARBBEZEICHNUNG	 LEATHER CREAM 75 ml	 EXCLUSIVE CARE 100 ml	 SHOE CREAM 50 ml	 VELOUR NUBUCK CARE 75 ml
	23 Blau <i>blue</i>	-	-	990254	907668
	25 Dunkelblau <i>dark blue</i>	907651	1103313	990057	906909
	67 Petrol <i>petrol</i>	901284	-	-	-
	58 Apfel <i>apple</i>	906890	-	-	-
	27 Grün <i>green</i>	-	-	-	907672
	33 Olive <i>olive</i>	-	-	990266	-
	96 Perlgrau <i>pearl grey</i>	-	-	990277	-
	44 Grau <i>grey</i>	-	-	990263	-
	46 Dunkelgrau <i>dark grey</i>	-	-	990253	-
	86 Graphit <i>graphite</i>	-	-	990259	-
	47 Schwarz <i>black</i>	907647	1103309	990064	907667
	61 Gold <i>gold</i>	-	-	990282	-
	62 Silber <i>silver</i>	-	-	990262	-
	95 Bronze <i>bronze</i>	-	-	990276	-
	97 Oro <i>oro</i>	-	-	990280	-



1. **SL COLOR PASTA**, 50 ml

dark brown	5470.022
red	5470.032
cherry red	5470.033
white	5470.043
cognac	5470.069
camel	5470.102
taupe	5470.116
noisette	5470.201

2. **RAPIDE**, 150 ml

Lederfett
Dubbin
Ledervet
Graisse de phoque

black	5475.00
brown	5475.01
neutral	5475.07

3. **PALC SL SELF SHINE**, 50 ml

Selbstglanz, topf mit Schwamm
Self shine, jar with sponge
Zelfglans-schoensmeer, pot met spons
Crème de cirage autolustrante, pot avec éponge

neutral	5460.01
white	5460.02
beige	5460.50
bordeaux	5460.26
dark blue	5460.82
black	5460.09
dark brown	5460.33
middle brown	5460.32
light brown	5460.31

4. **PALC SL OUTDOOR WAX**, 50 ml
546085

5. Glanzschwamm/Shoe polishing sponge
Zelfglansspons/Eponge lustrante
Leder/leather/leder/cuir **Master**
5340100



6. Einreibbürste/Cream brush/
Insmeerborstel/Brosse à enduire
Holz/wood/hout/bois **5370100**

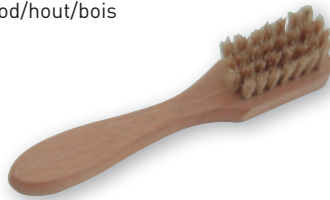

7. Glanzbürste/Polishing brush/
Opblinkborstel/Brosse à polir
10 x 4 cm Holz/wood/hout/bois **5370210**
14 x 5 cm Holz/wood/hout/bois **5370214**
15 x 4,5 cm Plastik mit Griff/plastic with grip/
plastic met greep/plastique avec manche **5370250**

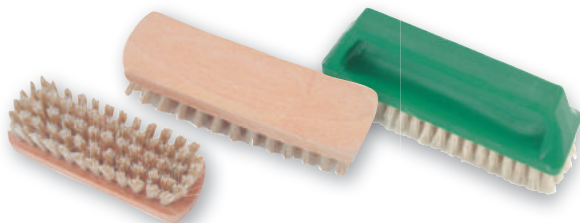

8. Wildlederbürste/Suede brush/
Suede borstel/Brosse à daim
Kupfer/brass/koper/cuivre **5370401**
Kupfer/brass/koper/cuivre + rubber **5370402**



9. Crepebürste/Crepe brush/
Crepeborstel/Brosse crêpe
12 x 4 cm **5370512**

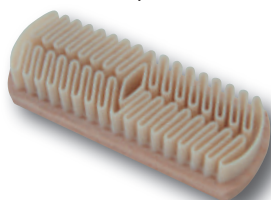

10. **RAPIDE**, 150 ml
Polierhandschuhe Schaf
Cleaning glove sheep
Poetshandschoen schaap
Gant à polir mouton
55631



11. **SL BLACK**,
Anstreichbürste schwarz, Holz/Rosshaar
Shoe cream brush black, wood/horsehair
Insmeerborstel zwart, hout/paardenhaar
Brosse à enduir noir, bois/crin de cheval
5370110

12. **SL LIGHT**
Anstreichbürste hell, Holz/Rosshaar
Shoe cream brush light, wood/horsehair
Insmeerborstel licht, hout/paardenhaar
Brosse à enduir clair, bois/crin de cheval
5370119

13. **SL LIGHT GLOSS**
Glanzbürste schwarz, Holz/Rosshaar
Polishing brush black, wood/horsehair
Opblinkborstel zwart, hout/paardenhaar
Brosse à polir noir, bois/crin de cheval
5370220

14. **SL LIGHT GLOSS**
Glanzbürste hell, Holz/Rosshaar
Polishing brush light, wood/horsehair
Opblinkborstel licht, hout/paardenhaar
Brosse à polir clair, bois/crin de cheval
5370229





RAINSTOP, 400 ml
5300400

Imprägnierder, Schutzmittel für jegliche Art von Leder und Textiel. Kann auch für Gore-tex verwendet werden.

Waterproofing to protect all types of leather and textile. Also suitable for Gore-tex.

Impregneerspray geschikt voor alle soorten leder en textiel. Ook geschikt voor gore-tex.

Imperméabilisant pour protéger toute sorte de cuire ainsi que textile. Aussi adéquate pour Gore-tex.





1. **TRG, SPRAY**, 150 ml

54415.

2. **TRG, HIGH GLOSS SPRAY**, 400 ml

5445000

neutral

3. **MAGIX/GRISON**, spray 400 ml

54440301 d.braun/d.brown/d.bruin/brun foncé

54440317 schwarz/black/zwart/noir

54440327 d.blau/navy blue/marineblau/bleu marine

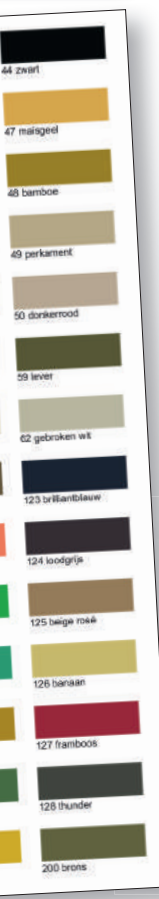

4. **MORELLO**, 1l

Grundfarbe, schwarz
Priming paint, black
Indringverf, zwart
Peinture de base, noir

54412001



5. **BRUSH-IT**, 30 ml

54403.

3 digits, z.B.:

3 cijfers, bijvoorbeeld:

3 digits, for example:

3 chiffres, par exemple:

54403.001 hemelsblauw

54403.018 oranje

54403.122 sun

VERSCHIEDENES - VARIOUS - DIVERSE - DIVERS

1. Schuhanzieher/Shoehorn/
Schoenlepel/Chausse-pied

15cm - Plastic

100ex. Assort.

53110100



2. 15cm - Plastic +Haken/+hook/+haak/+crochet

schwarz/black/zwart/noir
gelb/yellow/geel/jaune
grau/grey/grijs/gris
blau/blue/blauw/bleu
weiß/white/wit/blanc
grün/green/groen/vert
rot/red/rood/rouge

5311150

5311153

5311154

5311155

5311156

5311157

5311159



3. 32cm - Plastic

100ex. Assort.

53113100



4. 60cm - Plastic +Haken/+hook/+haak/+crochet

gelb/yellow/geel/jaune
blau/blue/blauw/bleu
rot/red/rood/rouge

5311603

5311605

5311609

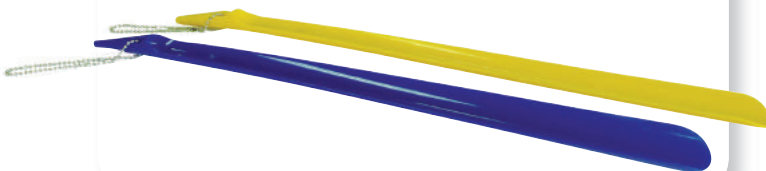

5. **Nickle** +Haken/+hook/+haak/+crochet

15cm

40cm

50cm

70cm

5314158

5314408

5314508

5314708



6. Schuhspanner/Shoe-tree/
Schoenspanner/Tendeur

Extra

Damen/women/dames/dames

5321015

Herren/men/heren/hommes

5321025

Hawede - Holz/wood/hout/bois

36/37 - Damen/women/dames/dames

5323136

38/39 - Damen/women/dames/dames

5323138

40/41 - Damen/women/dames/dames

5323140

40/41 - Herren/men/heren/hommes

5323340

42/43 - Herren/men/heren/hommes

5323342

44/45 - Herren/men/heren/hommes

5323344

46/48 - Herren/men/heren/hommes

5323346



7. Stiefelknecht/Boot jack/
Laarzenknecht/Retire-bottes

Holz/wood/hout/bois

5325000



8. **BAGSTOP**
 Gleitschutz für Schultertasche
 Self adhesive antislip for shoulder bag
 Zelfklevende antislip voor schoudertas
 Anti-dérapant autocollant pour sac à bandoulière

schwarz/black/zwart/noir 40ex. 51700
 Assort. 40ex. 51709



9. **TACCO SLIP**
 Fersen-Griff für geschlossene Schuhe
 Heel grip for closed shoes
 Hielgrip voor gesloten schoen
 Grip talon pour escarpin

Karte/Display/Kaart/Carte 25ex. 51710
 Dose/box/doors/boîte 50ex. 517110
 schwarz/black/zwart/noir
 Dose/box/doors/boîte 50ex. 517118
 grau/grey/grijs/gris

Selbstklebend
 Self adhesive
 Zelfklevend
 Autocollant



10. **TACCO SLING**
 Fersen-Griff für offene Schuhe
 Heel grip for open shoes
 Hielgrip voor open schoen
 Grip talon pour chaussures semi-ouvertes

Karte/Display/Kaart/Carte 30ex. 51720



Selbstklebend
 Self adhesive
 Zelfklevend
 Autocollant

WERKZEUGEN UND KLEINMASCHINEN
TOOLS AND SMALL MACHINERY
GEREEDSCHAPPEN EN KLEINE MACHINES
OUTILS ET PETITES MACHINES

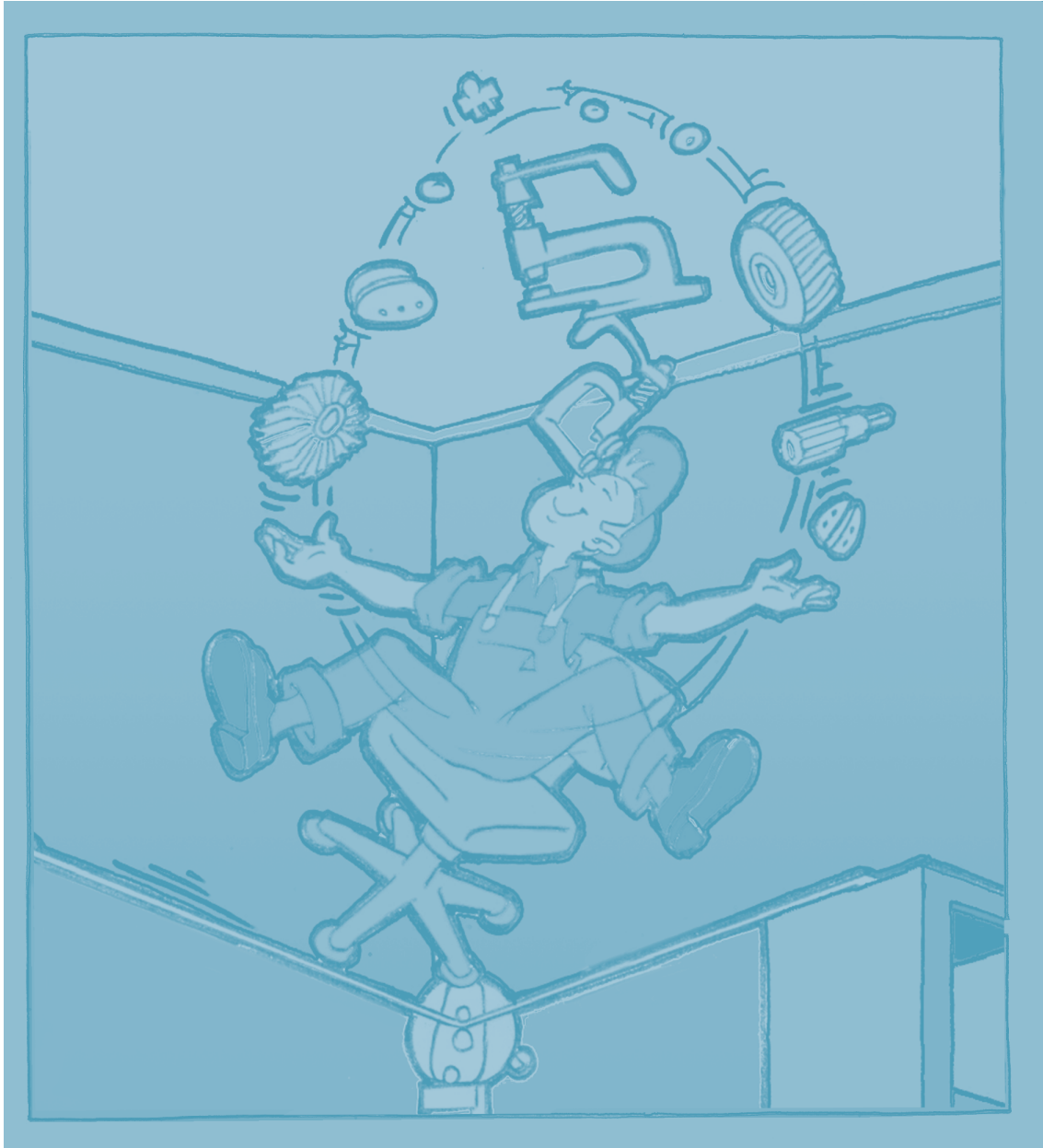

AFT[®]
AFT-International.com

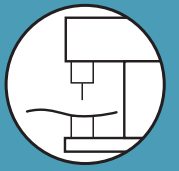

AFT INTERNATIONAL | GERMANY



BESCHLÄGE, SCHLÜSSEL UND ZUBEHÖR
METAL HARDWARE, KEYS AND ACCESSORIES
METAALWAREN, SLEUTELS EN TOEBEHOREN
QUINCAILLERIE, CLEFS ET ACCESSOIRES

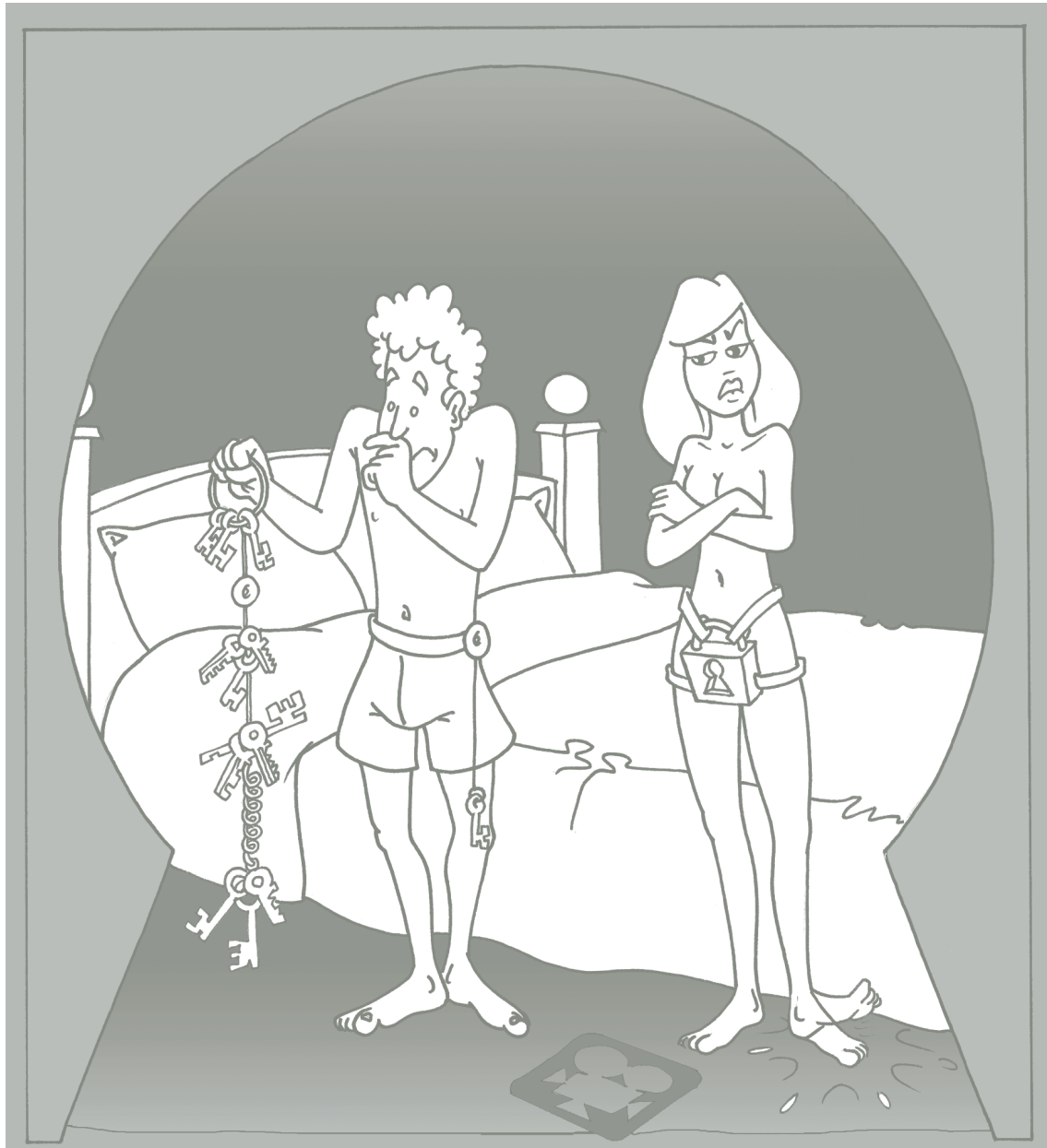

AFT[®]
AFT-International.com



10.01	EISENWARE FÜR SHUHE SMALL METAL HARDWARE FOR SHOES METAALWAREN VOOR SCHOEISEL QUINCAILLERIE	10.2
10.02	NÄHUTENSILIEN SEWING NECESSITIES BENODIGDHEDEN VOOR NAAIMACHINE ACCESSOIRES DE COUTURE	10.8
10.03	VERSCHIEDENES (REIßVERSCHLUß, VELCRO, ...) VARIOUS (ZIPPERS, VELCRO, ...) DIVERSE (RITSEN, VELCRO, ...) DIVERS (FERMETURES ÉCLAIR, VELCRO, ...)	10.10
10.04	SCHLÜSSEL UND ZUBEHÖR KEYS AND ACCESSORIES SLEUTELS EN TOEBEHOREN CLEFS ET ACCESSOIRES	10.12
10.05	KENNZEICHEN CAR REGISTRATION PLATES AUTO-NUMMERPLATEN PLAQUES D'IMMATRICULATION	10.21

KNÖPFE - BUTTONS - KNOPEN - BOUTONS

1. Jeansknöpfe
Jeans buttons
Jeansknopen
Boutons pour jeans

				50
14mm Kupfer brass koper laiton				<u>42532144</u>
14mm Kupfer brass koper laiton				<u>42532147</u>
14mm Kupfer brass koper laiton				<u>42532669</u>
14mm Dunkelbraun dark brown donkerbruin brun foncé				<u>42532671</u>
14mm Silber silver zilver argent				<u>42532149</u>
17mm Kupfer brass koper laiton				<u>42531145</u>
17mm Kupfer brass koper laiton				<u>42531675</u>
17mm Kupfer brass koper laiton				<u>42531138</u>
17mm Kupfer brass koper laiton				<u>42531148</u>
17mm Altkupfer oldbrass oudkoper bronzé				<u>42531674</u>
17mm Nickel nickel nikkel nickelé				<u>42531673</u>
17mm Altkupfer oldbrass oudkoper bronzé				<u>42531049</u>
17mm Dunkelbraun dark brown donkerbruin brun foncé				<u>42531678</u>
17mm Graphitgrau dark grey grafietgrijs gris graphite				<u>42531030</u>
17mm Silber silver zilver argent				<u>42531540</u>

2. Knöpfe, schwer (art.500)
Pushbutton, heavy (art.500)
Drukknop, zwaar (art.500)
Bouton-poussoir, lourd (art.500)

Antik/antique/antiek/antique 42500
Nickel/nickel/nikkel/nickelé 42504



3. Nagel für Jeansknöpfe
Nails for jeans button
Nagel voor jeansknop
Clou de bouton pour jeans



42533164

4. Sortiment Jeansknöpfe, Dose 180St.
Assorted jeans buttons, box 180p.
Assortiment jeansknopen, doos 180st.
Assortiment boutons pour jeans, boîte 180p.

425300



RIVETTEN - RIVETS - RIVETTEN - RIVETS

1. Rivetten

Rivets
Rivetten
Rivets

Kopf head kop tête		Nickel nickel nikkel nickelé	Kupfer brass koper laiton	
2mm		6mm	<u>4212068</u>	<u>4212069</u> 100
3mm		7mm	<u>4213078</u>	<u>4213079</u> 100
3mm		9mm	<u>4213098</u>	<u>4213099</u> 100
5mm		10mm	<u>4215108</u>	<u>4215109</u> 100
5mm		12mm	<u>4215128</u>	<u>4215129</u> 100
5mm		15mm	<u>4215158</u>	<u>4215159</u> 100

2. Messingrivetten

Messing rivets
Messingrivetten
Messing rivets

Kopf head kop tête		+Nickel +nickel +nikkel +nickelé	schwarz black zwart noir	
3mm		9mm	<u>4223098</u>	500
5mm		10mm	<u>4225108</u>	<u>4225100</u> 100
5mm		12mm	<u>4225128</u>	<u>4225120</u> 100
5mm		15mm	<u>4225158</u>	100

3. Sortiment Rivetten, Dose 2200St.

Assorted rivets, box 2200p.

Assortiment rivetten, doos 2200st.

Assortiment rivets, boîte 2200p.

4226000



STEMPEL - DIES - EMPORTE-PIÈCE - CACHETS

1. Set

100	<u>650700100</u>
SR93/103	<u>650700103</u>
S30/105	<u>650700105</u>
106	<u>650700106</u>

2. für Knöpfe/for pushbutton

voor drukknop/pour bouton-poussoir

leicht/light/licht/léger	<u>650700201</u>
Schwer/heavy/zwaar/lourd	<u>650700202</u>
S14Z	<u>650700203</u>

3. für Haken/for hook

voor haak/pour crochet

HK-1	<u>650700301</u>
HK-2	<u>650700302</u>
HK-3	<u>650700303</u>
491	<u>650700304</u>
510	<u>650700305</u>
515, easy-1671	<u>650700306</u>
1000, 1001	<u>650700307</u>

4. für Rivetten/for rivets

voor rivetten/pour rivets

206/S, 207/S, 209/S	<u>650700501</u>
510/S, 512/S, 515/S	<u>650700502</u>

5. für Senkelbleche/for lace hooks

voor veterijzertjes/pour ferrets lacets

rund-dünn/round-thin/rond-dun	<u>650700701</u>
rund-dik/round-thick/rond-dik	<u>650700702</u>
flach/flat/plat/plat	<u>650700703</u>

6. Lochpfeifen/hole punch

holpijp/emporte-pièce trous

1,0mm	<u>6507004010</u>
1,5mm	<u>6507004015</u>
2,0mm	<u>6507004020</u>
2,5mm	<u>6507004025</u>
3,0mm	<u>6507004030</u>
3,5mm	<u>6507004035</u>
4,0mm	<u>6507004040</u>
4,5mm	<u>6507004045</u>
5,0mm	<u>6507004050</u>
5,5mm	<u>6507004055</u>
6,0mm	<u>6507004060</u>
7,0mm	<u>6507004070</u>
8,0mm	<u>6507004080</u>
9,0mm	<u>6507004090</u>
10,0mm	<u>6507004100</u>
11,0mm	<u>6507004110</u>
12,0mm	<u>6507004120</u>



7. Messingamboss für Lochpfeifen

Brass anvil for hole punch

Aambeeld voor holpijp

Enclume laiton pour emporte-pièce trous

650700420



ÖSEN+HAKEN - EYELETS+HOOKS - RINGEN+HAKEN - OEILLETS+CROCHETS

1. Ösen
Eyelets
Ringen
Oeillets

100

	SR93 3mm	S30 5mm
R9005	<u>42359005</u>	<u>42369005</u>
VN	<u>42350001</u>	<u>42360001</u>
OCU	<u>42350002</u>	<u>42360002</u>
CU	<u>42350003</u>	<u>42360003</u>
A	<u>42350004</u>	<u>42360004</u>
R1019	<u>42351019</u>	<u>42361019</u>
R3007		<u>42363007</u>
R5004	<u>42355004</u>	<u>42365004</u>
R7024	<u>42357024</u>	
R8014	<u>42358014</u>	<u>42368014</u>
R8025	<u>42358025</u>	<u>42368025</u>
R8007	<u>49358007</u>	<u>42368007</u>
R6018		<u>42366018</u>
R5005		<u>42365005</u>
R5013		<u>42365013</u>
R2000		<u>42362000</u>
R3000		<u>42363000</u>
R3015		<u>42363015</u>
R9001		<u>42369001</u>
R7035		<u>42367035</u>
R1021		<u>42361021</u>

2. Haken
Hooks
Haken
Crochets

100

	HK-1	HK-2	HK-3
R9005	<u>426019005</u>	<u>426029005</u>	<u>426039005</u>
VN	<u>426010001</u>	<u>426020001</u>	<u>426030001</u>
OCU	<u>426010002</u>	<u>426020002</u>	<u>426030002</u>
A		<u>426020003</u>	<u>426030003</u>
R3007		<u>426023007</u>	
R5004	<u>426015004</u>	<u>426025004</u>	
R7024	<u>426017024</u>	<u>426027024</u>	
R8014	<u>426018014</u>	<u>426028014</u>	
R8007	<u>426018007</u>	<u>426028007</u>	

3. Ösen
Eyelets
Ringen
Oeillets

500

	VN	CU	R9005
3mm	<u>4231008</u>		
3mm	<u>4231038</u>	<u>4231039</u>	<u>4231030</u>
5mm	<u>4231058</u>	<u>4231059</u>	
6mm	<u>4231068</u>	<u>4231069</u>	



4. Haken (HK-515) + 2 Scheiben/2 Nieten
Hook (HK-515) + 2 discs/2 rivets
Haak (HK-515) + 2 rondellen/2 rivetten
Crochet (HK-515) + 2 rondelles/2 rivets

100

HK-515	R9005	A
	<u>426051500</u>	<u>426051502</u>

5. Ösenhaken (+ Scheibe/Niete*)
Eyelet hook (+ disc/rivet*)
Ringhaak (+ rondel/rivet*)
Oeillet-crochet (+ rondelle/rivet*)

100

	R9005	A
a 491	<u>42704910</u>	<u>42704912</u>
b 510	<u>42705100</u>	<u>42705102</u>
c 1000*	<u>42710000</u>	<u>42710002</u>
d 1001*	<u>42710010</u>	<u>42710012</u>

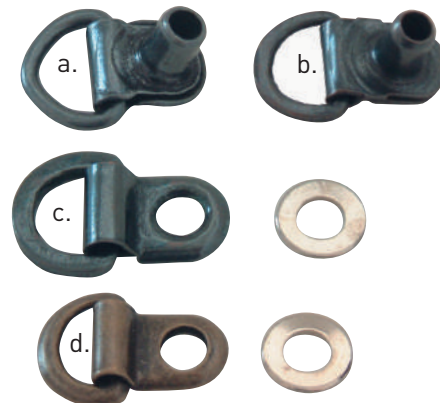

6. Easy-Roller + Scheibe/Niete
Easy-Roller + disc/rivet
Easy-Roller + rondel/rivet
Easy-Roller + rondelle/rivet

50

	R9005
	<u>42704000</u>

Für orthop. Schuhe; Schnürsenkel lassen sich einfach festbinden und lösen.
Especially for orthopaedic shoes; easy to tie up shoe or boot laces.
Voor orthopedische schoenen; makkelijk te strikken veters.
Pour chaussures orthopédiques; les lacets se nouent facilement.

SCHNALLE - BUCKLES - GESPEN - BOUCLES



	VN	CU	R9005
10 mm	<u>4110810</u>	<u>4110910</u>	
12 mm	<u>4110812</u>	<u>4110912</u>	<u>4111012</u>
14 mm	<u>4110814</u>	<u>4110914</u>	<u>4111014</u>
16 mm	<u>4110816</u>	<u>4110916</u>	<u>4111016</u>
18 mm	<u>4110818</u>	<u>4110918</u>	<u>4111018</u>
20 mm	<u>4110820</u>	<u>4110920</u>	<u>4111020</u>
22 mm	<u>4110822</u>	<u>4110922</u>	<u>4111022</u>
25 mm	<u>4110825</u>	<u>4110925</u>	<u>4111025</u>
30 mm	<u>4110830</u>	<u>4110930</u>	<u>4111030</u>



RAL

R1019	R3007	R5004	R7024	R8007	R8014	R8025	R9005	
graubeige grey-beige grijs-beige gris-beige	schwarzrot bordeaux bordeaux bordeaux	schwarzblau black-bleu zwartblauw noir-bleu	graphitgrau dark grey grafietgrijs gris graphite	mittelbraun med. brown middenbruin brun moyen	sepiabraun sepia brown sepiabruin brun sepia	blaßbraun dark beige donkerbeige beige foncé	schwarz black zwart noir	
R6018	R5005	R5013	R2000	R3000	R3015	R9001	R7035	R1021
gelbgrün yellow green geelgroen vert jaune	signalblau signal blue signaalblauw bleu de sécurité	Kobaltblau cobalt blue kobaltblauw bleu cobalt	gelborange yellow orange geeloranje orangé jaune	feuerrot flame red vuurrood rouge feu	hellrosa light pink lichtroze rose clair	cremeweiss cream crémewit blanc crème	lichtgrau light grey lichtgrijs gris clair	rapsgelb colza yellow koolzaadgeel jaune colza

A	VN	OCU	CU
Antik antique antiek antique	Vernickelt nickel plated vernikkeld nickelé	Altkupfer oldbrass oudkoper bronzé	Kupfer brass koper laiton



CAMBROTALS



mod. 10 sehr lang/extra long/zeer lang/extra longue - 12cm [4407010ZL](#)



mod. 31 kurz/short/kort/courte - 10cm [4407031K](#)



mod. 31 sehr lang/extra long/zeer lang/extra longue - 12cm [4407031ZL](#)



mod. 67 klein/small/klein/petit - 9cm [4407067](#)



mod. 69 kurz/short/kort/courte - 10,5cm [4407069K](#)



Rivetten für Cambrotals
 Rivets for cambrotal
 Rivetten voor cambrotal
 Rivets pour cambrotal

Alu. - Ø 3mm x 25mm

[4210258](#)

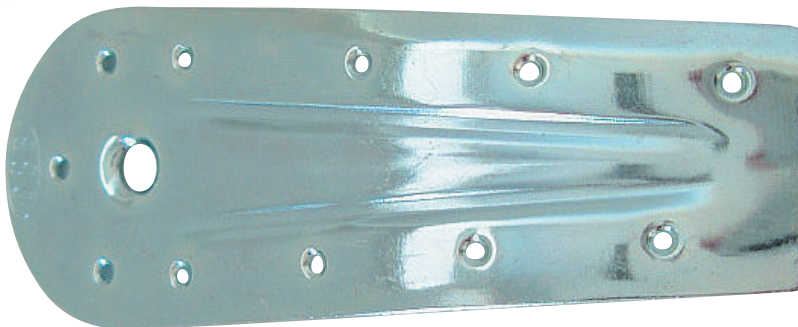

nr20 für Stifte/for nails/voor nagels/pour clous

[440620](#)

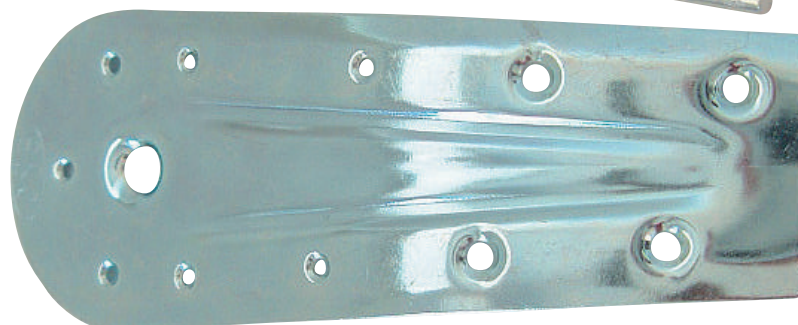

nr23 für Rivetten/for rivets/voor rivetten/pour rivets

[440623](#)

STIFTE - NAILS - SPIJKERS - CLOUS

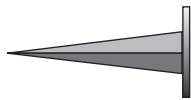
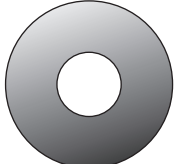

1. Gestauchte stifte Nails brad head Spijkers 'tête homme' Clous tête homme		1,1 x 20mm	<u>451031120</u>	1kg.
		1,1 x 23mm	<u>451031123</u>	1kg.
		1,1 x 25mm	<u>451031125</u>	1kg.
		1,3 x 20mm	<u>451031320</u>	1kg.
		1,3 x 30mm	<u>451031330</u>	1kg.
2. Schraubnägel Screwnails Schroefnagels Pointes filet roulé		1,8 x 22mm	<u>451041822</u>	1kg.
3. Drahthandtacks Semence nails Semences Semences		12mm	<u>4510512</u>	1kg.
4. Trix Stahlstifte Steel nails Stalen spijkers Clous en acier		12/17	<u>4510712175</u>	1kg.
5. Nagel für Nagler Nails for pneumatic nailer Machinenagels 'brads' Clous pour cloueuse pneum.		15mm	<u>6003410115</u>	box
		20mm	<u>6003410120</u>	box
		25mm	<u>6003410125</u>	box
6. Speedmaster Speedmaster Speedmaster Speedmaster		ø 0,8mm	<u>4510980</u>	1kg. pro Rolle
7. Kreuzschlitzschrauben Cruciform screws Parkervijzen Vices cruciformes		4,5 x 25mm	<u>4409</u>	200p.
8. Kopfplatten Metal plates Rondellen Rondelles		Ø22mm	<u>4408</u>	box



NADELN - NEEDLES - NAALDEN - AIGUILLES

NR 81

 10

100	<u>6860810100</u>
110	<u>6860810110</u>
120	<u>6860810120</u>
130	<u>6860810130</u>
140	<u>6860810140</u>



NR 332

90	<u>6863320090</u>
100	<u>6863320100</u>
110	<u>6863320110</u>
120	<u>6863320120</u>
130	<u>6863320130</u>
140	<u>6863320140</u>
160	<u>6863320160</u>



NR 332LL

110	<u>6863324110</u>
120	<u>6863324120</u>
130	<u>6863324130</u>
140	<u>6863324140</u>
160	<u>6863324160</u>



NR 332LG

100	<u>6863325100</u>
110	<u>6863325110</u>
120	<u>6863325120</u>
140	<u>6863325140</u>
160	<u>6863325160</u>



für Durchnähmaschinen
for blackstitchingmachines
voor doornaaimachines
pour machines Blake

 10

Raffl. 4002HL nr.4	<u>68640020004</u>
Raffl. 4002HL nr.5	<u>68640020005</u>
Raffl. 4002HL nr.6	<u>68640020006</u>
Raffl. 6021 nr.41	<u>68660210041</u>
Raffl. 6021 nr.45	<u>68660210045</u>
BT 4035 nr.5	<u>68640350005</u>
BT 4035 nr.6	<u>68640350006</u>
6002 nr.47	<u>68660020047</u>
HN 90/45/190 55 G1	<u>6869045190G1</u>

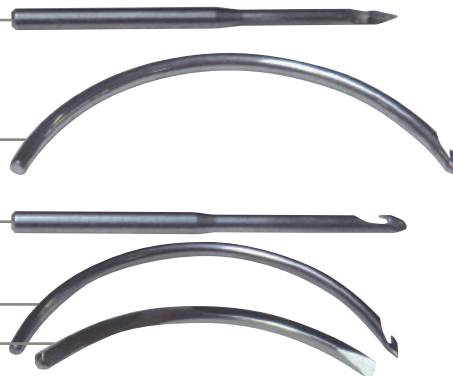

GARN - THREAD - GARENS - FIL À COUDRE



Seidenersatz
Sewing thread natural
Garen naturel
Fil à coudre naturels

68410.



in 11 Farben
all 11 colours
in 11 kleuren
toutes les 11 couleurs



Faden Neverstrand
thread Neverstrand
Neverstrand garen
file Neverstrand

schwarz/black/zwart/noir - 0,4 kg

68460

braun/brown/bruin/brun - 0,4 kg

68461

weiß/white/wit/blanc - 0,4 kg

68466



NATUREL

200	197	161	106	101	100
weiß white wit blanc	sant sand zand sable	bordeaux bordeaux bordeaux	mittelbraun medium brown middenbruin brun moyen	dunkelbraun dark brown donkerbruin brun foncé	schokoladenbraun chocolate brown chocoladebruin brun chocolat
136	183	146	172	165	
schwarz black zwart noir	dunkelgrau dark grey donkergrijs gris foncé	dunkelblau dark blue donkerblauw bleu foncé	dunkelgrün dark green donkergroen vert foncé	rot red rood rouge	

Farbabweichungen zwischen dem Farbdruck und dem Originalprodukt sind möglich.
Colour differences between print and original product are possible.
Kleurverschillen tussen het drukwerk en het origineel produkt zijn mogelijk.
Des différences de couleur entre l'imprimerie et la produit originale sont possible.



REIßVERSCHLUß - ZIPPERS - RITSEN - FERMETURES ÉCLAIR

1. Nylon
nylon
nylon
nylon

	schwarz black zwart noir	braun brown bruin brun
8cm	<u>87008</u>	<u>87108</u>
10cm	<u>87010</u>	<u>87110</u>
12cm	<u>87012</u>	<u>87112</u>
15cm	<u>87015</u>	<u>87115</u>
18cm	<u>87018</u>	<u>87118</u>
20cm	<u>87020</u>	<u>87120</u>
22cm	<u>87022</u>	<u>87122</u>
25cm	<u>87025</u>	<u>87125</u>
28cm	<u>87028</u>	<u>87128</u>
30cm	<u>87030</u>	<u>87130</u>
32cm	<u>87032</u>	<u>87132</u>
35cm	<u>87035</u>	<u>87135</u>
38cm	<u>87038</u>	<u>87138</u>
40cm	<u>87040</u>	<u>87140</u>
42cm	<u>87042</u>	<u>87142</u>
45cm	<u>87045</u>	<u>87145</u>
50cm	<u>87050</u>	<u>87150</u>
55cm	<u>87055</u>	<u>87155</u>
60cm	<u>87060</u>	<u>87160</u>
65cm	<u>87065</u>	<u>87165</u>
70cm	<u>87070</u>	<u>87170</u>
75cm	<u>87075</u>	<u>87175</u>
80cm	<u>87080</u>	<u>87180</u>
85cm	<u>87085</u>	<u>87185</u>
90cm	<u>87090</u>	<u>87190</u>
95cm	<u>87095</u>	<u>87195</u>
100cm	<u>87099</u>	<u>87199</u>



2. Metall
metal
metaal
métal

	schwarz black zwart noir	braun brown bruin brun
8cm	<u>88008</u>	<u>88108</u>
10cm	<u>88010</u>	<u>88110</u>
12cm	<u>88012</u>	<u>88112</u>
15cm	<u>88015</u>	<u>88115</u>
18cm	<u>88018</u>	<u>88118</u>
20cm	<u>88020</u>	<u>88120</u>
22cm	<u>88022</u>	<u>88122</u>
25cm	<u>88025</u>	<u>88125</u>
28cm	<u>88028</u>	<u>88128</u>
30cm	<u>88030</u>	<u>88130</u>
32cm	<u>88032</u>	<u>88132</u>
35cm	<u>88035</u>	<u>88135</u>
38cm	<u>88038</u>	<u>88138</u>
40cm	<u>88040</u>	<u>88140</u>
42cm	<u>88042</u>	<u>88142</u>
45cm	<u>88045</u>	<u>88145</u>
50cm	<u>88050</u>	<u>88150</u>
55cm	<u>88055</u>	<u>88155</u>
60cm	<u>88060</u>	<u>88160</u>
65cm	<u>88065</u>	<u>88165</u>
70cm	<u>88070</u>	<u>88170</u>
75cm	<u>88075</u>	<u>88175</u>
80cm	<u>88080</u>	<u>88180</u>
85cm	<u>88085</u>	<u>88185</u>
90cm	<u>88090</u>	<u>88190</u>
95cm	<u>88095</u>	<u>88195</u>
100cm	<u>88099</u>	<u>88199</u>



4. Prym

482411	<u>8630111</u>
482113	<u>8630113</u>
482121	<u>8630121</u>
482132	<u>8630132</u>
482133	<u>8630133</u>
482138	<u>8630138</u>

482172	<u>8630272</u>
482173	<u>8630273</u>
482183	<u>8630283</u>



(100%)



VERSCHIEDENES - VARIOUS - DIVERSE - DIVERS

3. Nylon, schwer - offen
 nylon, heavy - open
 nylon, zwaar - open
 nylon, lourd - ouverte

	schwarz black zwart noir	braun brown bruin brun
50 cm	<u>894050</u>	<u>894150</u>
55 cm	<u>894055</u>	<u>894155</u>
60 cm	<u>894060</u>	<u>894160</u>
65 cm	<u>894065</u>	<u>894165</u>
70 cm	<u>894070</u>	<u>894170</u>
75 cm	<u>894075</u>	<u>894175</u>
80 cm	<u>894080</u>	<u>894180</u>
85 cm	<u>894085</u>	<u>894185</u>



5. pro Meter, Nylon
 per metre, nylon
 per meter, nylon
 par mètre, nylon

schwarz/black/zwart/noir
 braun/brown/bruin/brun

8600
8601



6. Schlitten, Nylon
 Fastening, nylon
 Schuiver, nylon
 Glissière, nylon

schwarz/black/zwart/noir
 braun/brown/bruin/brun

100

8610
8611



7. Stopper
 Stopper
 Stopper
 Arrêt

für oben/above/boven/dessus
 für unten/below/onder/dessous

100

8620
8621

1. Velcro

25m

black white

25mm		<u>8500251</u>	<u>8506251</u>
25mm		<u>8500252</u>	<u>8506252</u>
30mm		<u>8500301</u>	<u>8506301</u>
30mm		<u>8500302</u>	<u>8506302</u>
50mm		<u>8500501</u>	<u>8506501</u>
50mm		<u>8500502</u>	<u>8506502</u>

2. Velcro ADS

25m

Selbsthaftend/adhesive/zelfklevend/autocollant

black white

25mm		<u>8510251</u>	<u>8516251</u>
25mm		<u>8510252</u>	<u>8516252</u>
50mm		<u>8510501</u>	<u>8516501</u>
50mm		<u>8510502</u>	<u>8516502</u>



3. Reparaturetikett, Rolle 500St.

Repair label, rol 500p.
 Etiket reparatie, rol 500st.
 Étiquette réparation, rouleau 500p.

	NL	FR
gelb/geel/yellow/jaune	<u>822004</u>	<u>822104</u>
blau/blue/blauw/bleu	<u>822008</u>	<u>822108</u>
rot/red/rood/rouge	<u>822009</u>	<u>822109</u>
grün/green/groen/vert	<u>822007</u>	<u>822107</u>

4. Halter für Etiketten, Holz
 Holder for labels, wood
 Houder voor etiketten, hout
 Porte-étiquettes, bois

8225

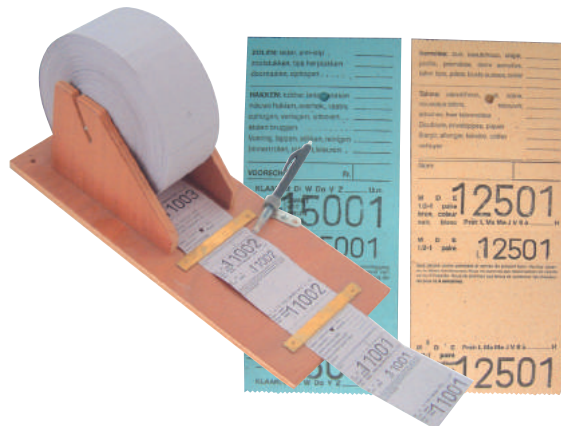

SCHLÜSSEL - KEYS - SLEUTELS - CLEFS

1. JMA

Schlüssel

keys

sleutels

Clefs

a. Normal



b. Ultralight: litto + universal



c. Kreuz Schlüssel/cruciform/kruisvorm/cruciformes



f. Fashion U5D - 24ex.



Für den vollständigen Programm:
For the complete program:
Voor het volledige programma:
Pour le programme détaillé :

www.jma.es

d. Bohrmulden- oder Bahnenschlüssel

Dimple and laser-keys

Boor- en langsfreesleutels

Clefs à points et fraisées



e. Autoschlüssel/Car keys/Autosleutels/Clefs de voiture



2. **Möbelschlüssel**

 10

Furniture keys
Meubelsleutels
Clefs à meubles

Junie 483	8x6mm	40mm	Brown Messing
Junie 478	8x6mm	40mm	Nickle
Junie 383	8x6mm	40mm	Brown Messing
Junie 520	8x6mm	45mm	Brown Messing Tin
Junie 320	8x6mm	40mm	Brown Messing
Junie 339	8x6mm	40mm	Brown Messing



3. **BASI co**

Zylinder
Cylinder
Cilinder
Cylindre



40mm	10/30	<u>930401030</u>	
60mm	30/30	<u>930603030</u>	
60mm	30/30	<u>930603030GS</u>	
65mm	30/35	<u>930653035</u>	
70mm	30/40	<u>930703040</u>	
70mm	35/35	<u>930703535</u>	
75mm	30/45	<u>930753045</u>	
75mm	35/40	<u>930753540</u>	
80mm	40/40	<u>930804040</u>	
knop	60mm	30/30	<u>93K603030</u>
key original	60mm	30/30	<u>93KBASI</u>

JMA SCHLÜSSELMASCHINEN - KEY MACHINES - SLEUTELMACHINES - MACHINES À CLEFS

1. Vienna	<u>95001100</u>
Vienna Smart	<u>95001150</u>
Ecco	<u>95001200</u>
Ecco Plus	<u>95001250</u>
Titan Bit	<u>95002100</u>
Ecco Bit	<u>95002200</u>
Saratoga	<u>95002500</u>
Capri	<u>95003100</u>
Capri Smart	<u>95003150</u>
Dakki	<u>95003200</u>



Für den vollständigen Programm:
For the complete program:
Voor het volledige programma:
Pour le programme détaillé :
www.jma.es



ZUBEHÖR - ACCESSORIES - TOEBEHOREN - ACCESSOIRES

1. Schlüsselring

Key-ring
Sleutelring
Anneau de clef

Regular	Ø25mm	400ex.	<u>910010</u>
Neon Fluo	Ø25mm	400ex.	<u>910015</u>
Keyring big	Ø29mm	320 ex.	<u>910020</u>

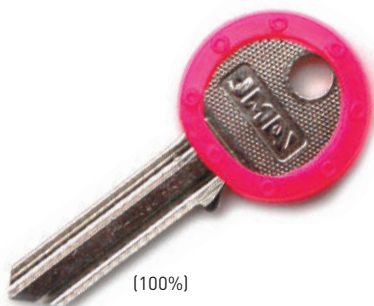

(100%)

2. Schlüsselkappe

Key cap
Sleuteldopje
Capuchon plast. de clef

Regular		400ex.	<u>910110</u>
Neon Fluo		400ex.	<u>910115</u>
Square	29x27mm	200ex.	<u>910120</u>
Poker design		400ex.	<u>910130</u>



(100%)

3. Schlüsselringe

Key-rings
Sleutelringen
Anneau brisés

Metall/metal/metaal/métalle

Assort.	320ex.	<u>910300</u>
17mm	200ex.	<u>910317</u>
21mm	200ex.	<u>910321</u>
23mm	200ex.	<u>910323</u>
25mm	200ex.	<u>910325</u>
28mm	200ex.	<u>910328</u>
30mm	200ex.	<u>910330</u>
35mm	200ex.	<u>910335</u>
51mm	50ex.	<u>910351</u>

Kupfer/brass/koper/laiton

17mm	200ex.	<u>9103917</u>
21mm	200ex.	<u>9103921</u>
28mm	200ex.	<u>9103928</u>



4. Schlüsseletikette mit Ring

Key label with ring
Sleuteletiket met ring
Étiquette de clef avec anneau

Assort.	22x51mm	200ex.	<u>910210</u>
black	22x51mm	200ex.	<u>910220</u>
yellow	22x51mm	200ex.	<u>910222</u>
purple	22x51mm	200ex.	<u>910227</u>
l.blue	22x51mm	200ex.	<u>910228</u>
red	22x51mm	200ex.	<u>910229</u>



Kevron Assort.	29x57mm	96ex.	<u>910240</u>
----------------	---------	-------	----------------------



SCHLÜSSELANHÄNGER - KEY CHAIN - SLEUTELHANGER - PORTE-CLÉS

5. 'PUSH'

Nickel/nickel/nikkel/nickelélé 39x15mm 12ex. 927038
Kupfer/brass/koper/laiton 39x15mm 12ex. 927039



6. Clip + Kette 45 cm
Clip + chain 45 cm
Clip + ketting 45 cm
Clip + chain 45 cm



928050

7. Schlüsselkette 40 cm
Key chain 40 cm
Sleutelketting 40 cm
Porte clé, chaîne métallique 40 cm

Nickel/nickel/nikkel/nickelélé 2mm 12ex. 927540



8. Karabinerhaken
Snaphook
Musketon
Musqueton

plastic - 12ex. Assort.

926020



9. Nickel/nickel/nikkel/nickelélé - nr.1

1ex.

926001



10. Metal Assort.

30ex. (6x5)

925630



50%

NEU
NEW
NIEUW
NOUVEAU

11. Berghaken mit Ring
Stretch hook with ring
Berghaak met ring
Crochet alpin avec anneau

Aluminium

5 x 50mm	1ex.	<u>910405</u>
6 x 60mm	1ex.	<u>910406</u>
8 x 80mm	1ex.	<u>910408</u>



12. 'FOTO'

Acrylic 46x60mm 1ex. 922400



13. '5 RINGS'

1ex. 925900



14. 'BOTTLE OPENER'

1ex. 925700



15. 'METAL + BLACK'

Acrylic 46x60mm 1ex. 925800



Kann graviert werden
Can be engraved
Kan gegraveerd worden
Peut être gravé

16. 'FOOTBALL'

assort.	24ex. (4x6)	<u>923024</u>
footbal 1	1ex.	<u>923001</u>
footbal 2	1ex.	<u>923002</u>
footbal 3	1ex.	<u>923003</u>
footbal 4	1ex.	<u>923004</u>



50%)



SCHLÜSSELANHÄNGER - KEY CHAIN - SLEUTELHANGER - PORTE-CLÉS

17. 'CHARME'

Assort. 48ex. (display NOT included!) 920848



NEU
 NEW
 NIEU
 NOUVEAU

19. 'HOROSCOPE'

Assort. 48ex. (display NOT included!) 921512



18. 'ALL STARS'

Assort. 24ex. (display NOT included!) 922924



NEU
 NEW
 NIEU
 NOUVEAU

20. 'WHATSAPP'

Assort. 48ex. (display NOT included!) 922072



21. 'LETTER'

assort.	104ex. (display included!)	<u>92051104</u>
shiny	1ex.	<u>92051 -</u>
shiny	26ex.	<u>9205126</u>
mat	1ex.	<u>92052 -</u>
mat	26ex.	<u>9205226</u>

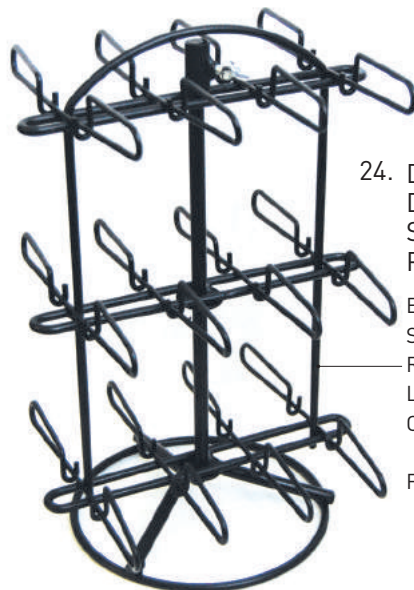
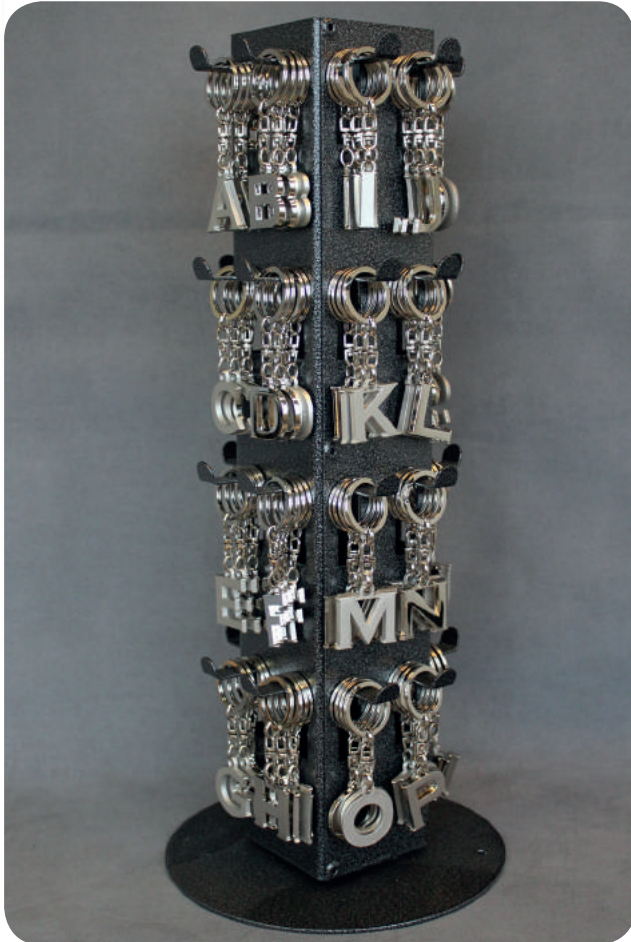

24. Display für Schlüsselanhänger (leer)
Display for key chains (empty)
Staander voor sleutelhangers (leeg)
Présentoir pour porte-clés (vide)

Black	12 hooks	<u>945012</u>
Straight	24 hooks	<u>9450141</u>
Round	24 hooks	<u>9450142</u>
Luxe	32 hooks	<u>945032</u>
Carton	12 hooks	<u>945040</u>
Floor	no hooks	<u>945200</u>
	hook	<u>945201</u>

Assortiment ohne Display
Assortiment without display
Assortiment zonder display
Assortiment sans présentoir



ZUBEHÖR - ACCESSORIES - TOEBEHOREN - ACCESSOIRES

25. Schlüsselbehälter mit Reißverschluss
Key pocket with zipper
Sleutetui met rits
Pochet-clés avec fermeture éclair

412709 Assort. 11,5x7cm 6x1ex. **9108029**



415303 black 12x8cm 1ex. **9108030**
415303 Assort. 12x8cm 10x1ex. **9108039**

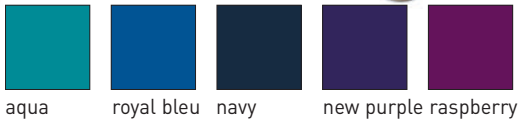

402703 black 11,5x8,5cm 1ex. **9108040**
402703 Assort. 11,5x8,5cm 10x1ex. **9108049**

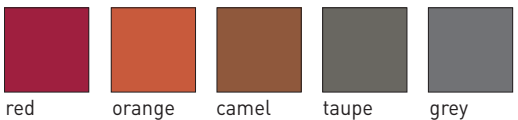

26. Schlüsselbehälter
Key pocket
Sleutetui 'klok'
Pochet-clés

410309 black 11,5x7cm 1ex. **9108010**



27. Koffer Etikett
Luggage label
Kofferlabel
Etiquette bagage

Assort. 5,5x7,5cm 48ex. **910648**

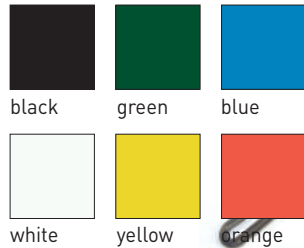

28. Koffergurtel
Luggage belt
Kofferriem
Ceinture bagage

black 1ex. **910700**
red 1ex. **910709**
rainbow 1ex. **910710**



Farben können je nach Saison variieren
Colours may vary according to the season
Kleuren kunnen per seizoen verschillen
Couleurs peuvent varier selon la saison

KENNZEICHEN - CAR REGISTRATION PLATES - AUTOPLATEN - PLAQUES D'IMMATR.

1. Kennzeichen Belgien
Car registration plates Belgium
Autoplaten België
Plaques d'immatriculation Belgique

7 digit zonder punt	<u>90120</u>
7 digit met punt	<u>90121</u>
7 digit Z-plaat groen	<u>90127</u>
7 digit traktor	<u>90128</u>
7 digit 4x4 - 34x21cm	<u>90129</u>
7 digit 4x4 - traktor	<u>90130</u>



2. Rahmen für Kennzeichen
Frame for car registration plates
Frame voor auto platen
Cadre pour plaques d'immatriculation

Voorzijde - rood	<u>90312</u>
Voorzijde - zilver	<u>90313</u>

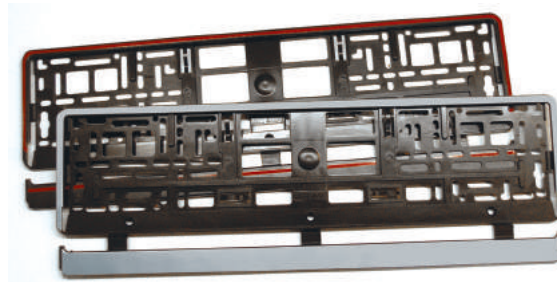

3. PRES1500 Kompleet
Kennzeichenpresse + buchstaben
Press registration plates +letters
Pers auto platen +letters
Presse plaques d'immatriculation +caractères

90000

NEU
NEW
NIEUW
NOUVEAU

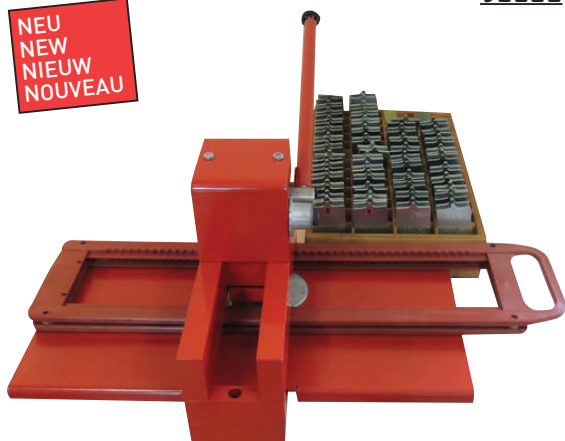

4. F85 Kompleet
Kennzeichenpresse + buchstaben
Press registration plates +letters
Pers auto platen +letters
Presse plaques d'immatriculation +caractères

90001

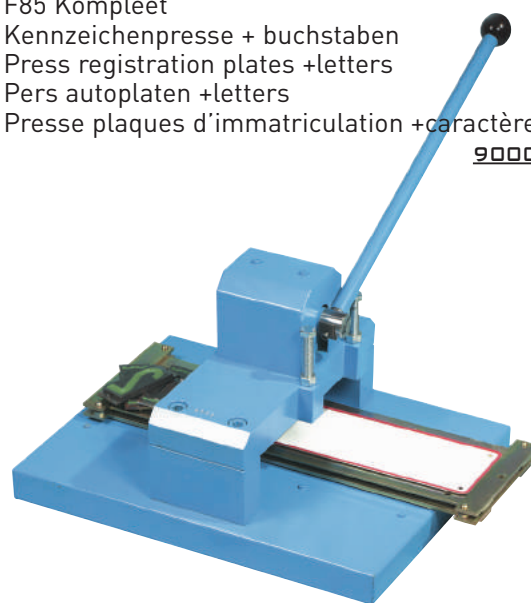



**GRÖSSENTABELLE
SIZES
MATENTABEL
GABARITS**



AFT International nv
Ter Stratenweg 50,
B-2520 Oelegem, BELGIUM
T: +32 (0)3 475 93 03
F: +32 (0)3 475 93 20
info@aft-international.be

AFT International GmbH
Eichenhofer Weg 1
D-42279 Wuppertal, GERMANY
T: +49 (0)202 64774 0
F: +49 (0)202 64774 20
info@aft-international.de

www.aft-international.com