

ENDOLITE

Trans-tibial Shower Limb

Including Full Integral Cosmesis



aqualimb

*Aqualimb is a registered trademark
of Chas. A. Blatchford & Sons Ltd.*

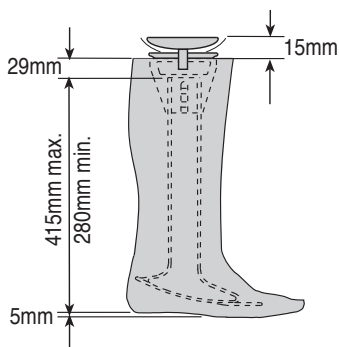
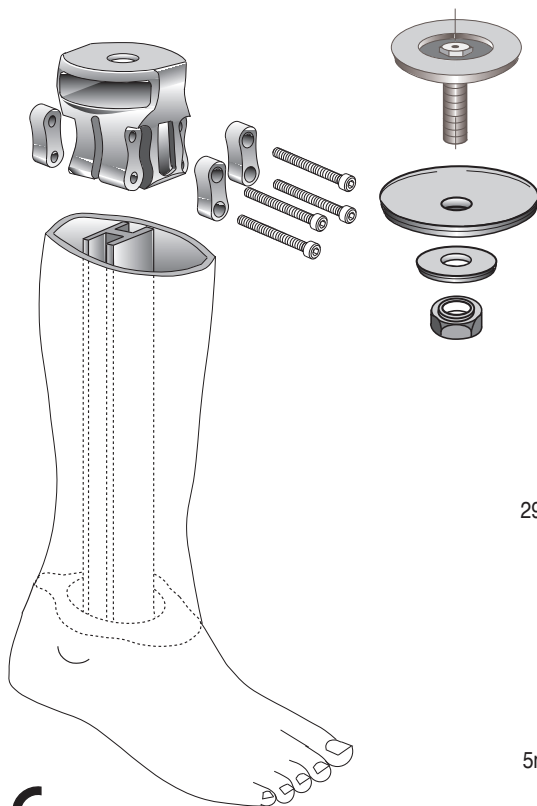

CE

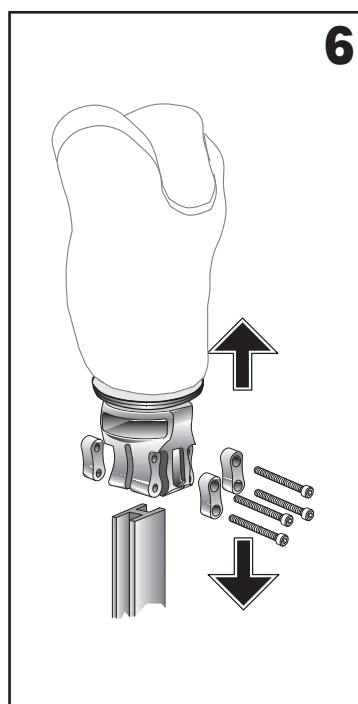
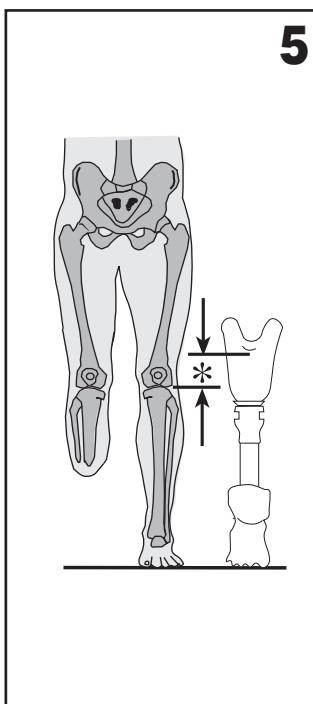
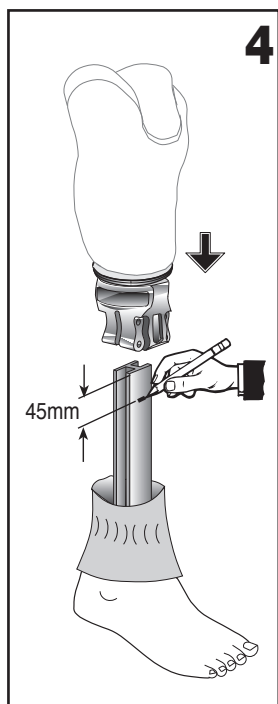
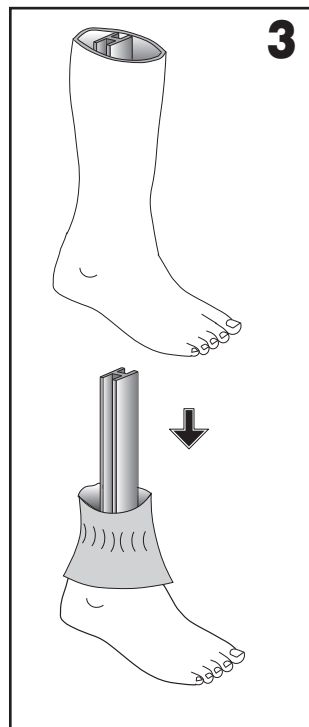
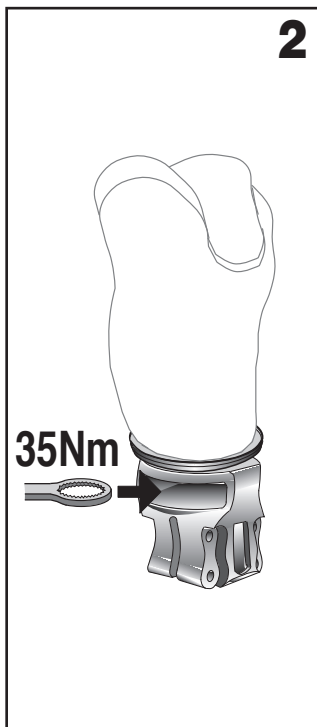
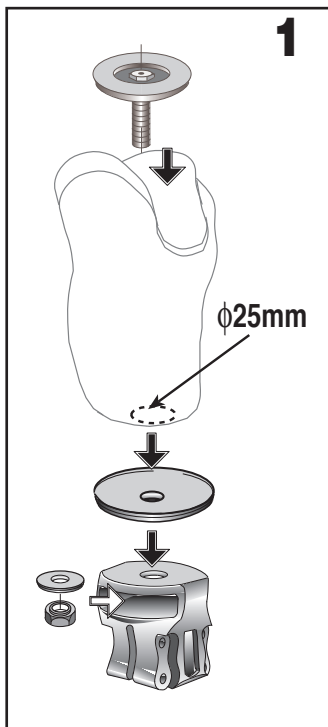

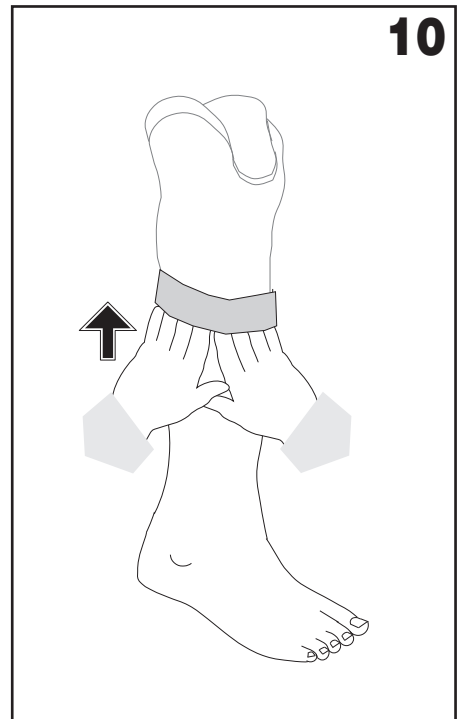
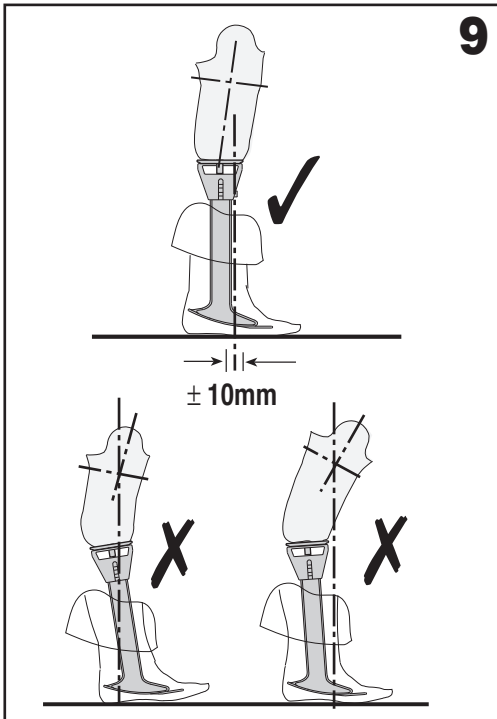
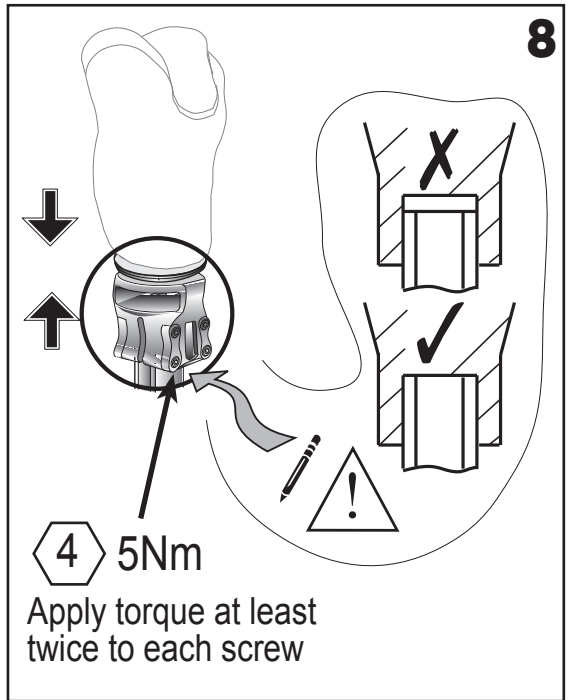
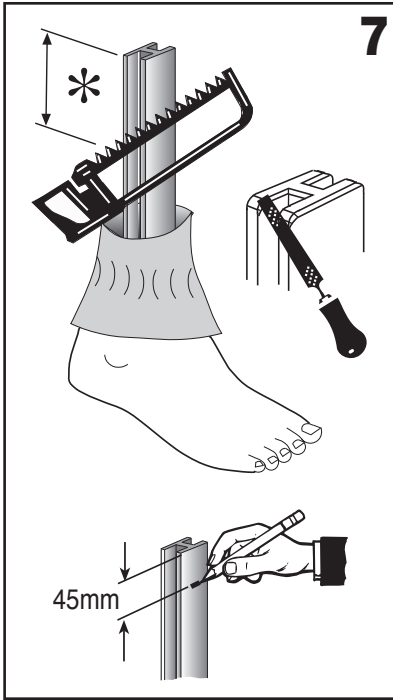

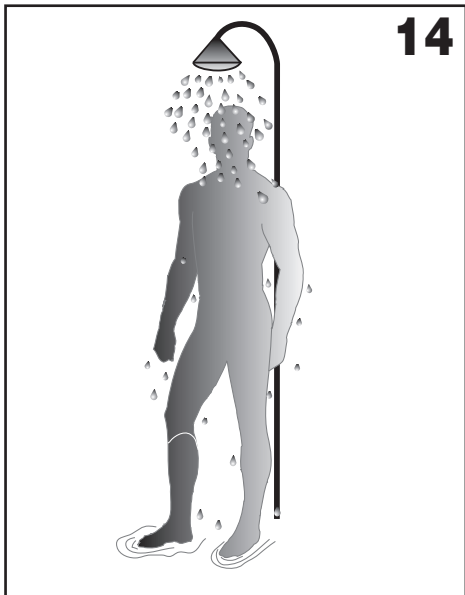
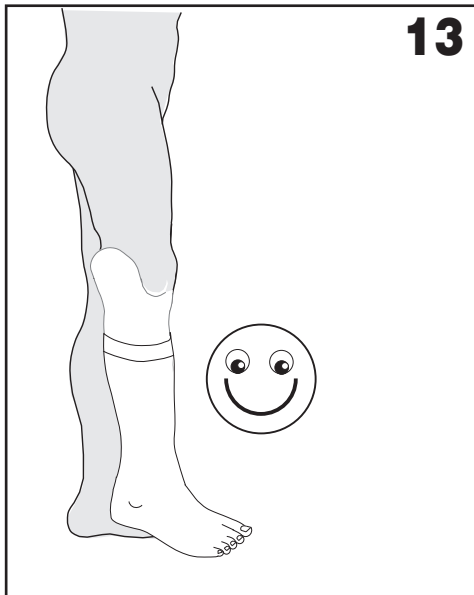
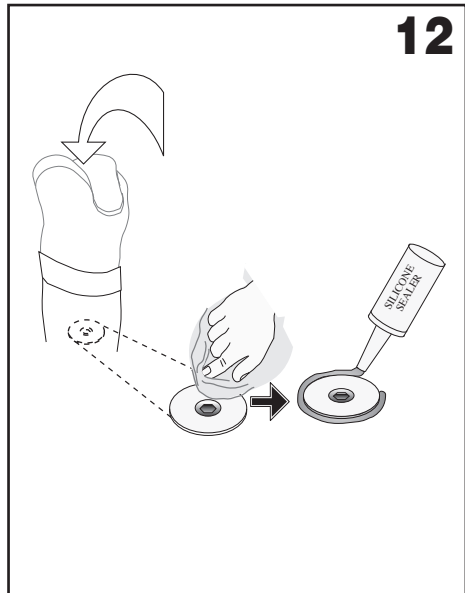
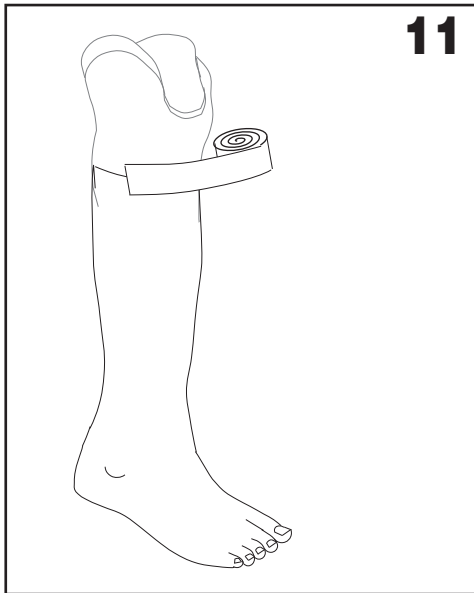

ENDOLITE

Blatchford Products Ltd

Lister Road, Basingstoke, Hampshire, RG22 4AH, United Kingdom

Telephone: +44 (0)1256 316600 Facsimile: +44 (0)1256 479705

Email: sales@blatchford.co.uk www.blatchford.co.uk

Blatchford Products Limited and ENDOLITE are companies and trademarks of Chas. A. Blatchford and Sons Ltd.

938255/03-0208