

# Newport<sup>®</sup> lite™

The new Newport lite hip orthosis from Orthomerica is designed to provide protection and support for patients at risk for problems related to hip instability.

## Indications

- Arthroscopic hip procedures
- Labral repair, with or without gluteus medius repair
- Post-op proximal hamstring repair
- Patients at risk to dislocate

## Contraindications

- Global instability
- Patients at risk for an anterior dislocation
- Chronic dislocation

## Features/Benefits

- Protects the hip joint capsule by providing a limited and safe range of motion following surgical procedures
- Well-tolerated by patients
- Virtual joint is easily set to control hip flexion, extension, adduction and abduction
- Proprioceptive reminder
- Universal for right or left side
- Easily customized to provide an exact fit
- One size fits most
- Laterally placed abduction paddle helps to maintain the head of the femur in the acetabulum
- Compression belt design with pull tabs anchors the hip joint and thigh cuff to promote optimal alignment
- Accommodates hip development through ball joint mechanism



Newport<sup>®</sup> lite™ Hip Orthosis one size fits most waists 26"–66" (66cm–167cm)

Item	Model #
Complete Orthosis	3662
Abduction Control Joint	3662.03
Pelvic Component	3662.04
Replacement Pad Kit	3662.05

The **Newport 3 Hip Orthosis** has been the industry standard for over a decade. Innovations like the patented clamping disks, allowing precise contouring of the pelvic section and the Universal Virtual Joint, which provides unprecedented strength in a small component, have made the Newport Hip Orthosis the most popular choice for physicians, orthotists, and patients, worldwide.

### Indications

- Post-operative hip revision patients
- Primary arthroplasty patients at risk to dislocate
- Patients needing stability after dislocation
- Inoperable patients requiring hip stabilization
- Patients who can benefit from a hip orthosis to reinforce hip precautions

### Unisex Pelvic Component

- Male/Female adjustability with unique patented disk technology
- Single-push click'n close fastener for simple donning and doffing, Chafe and loop also available

### Virtual Hip Joint

- Abduction, adduction, flexion, extension adjustments

### Optional, unilateral ARC™ (Anti-Rotation Cable) is available.

- Infinite adjustment of internal/external rotation
- Modular—fits all Newport® Hip Systems
- Washable, CoolFoam™ liner



Size	Model # with Virtual Hip Joint		(sold unassembled)	Thigh Circ.			
	With Assembled Side Specific Thigh Cuff	With Universal Thigh Cuff		Waist Circ.	Hip Circ.	Proximal	Distal
Small	3640	3645	3640.40	22"-28"	26"-32"	15"-21"	12"-17"
Medium	3641	3646	3641.41	28"-34"	32"-38"	17"-24"	13"-18"
Large	3642	3647	3642.42	34"-40"	38"-44"	19"-27"	14"-20"
X-Large	3643	3648	3643.43	40"-46"	44"-50"	21"-29"	17"-23"

### Hip Joint Options

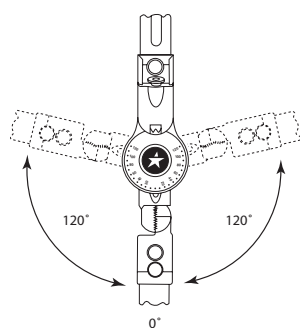

Virtual® Joint (standard with Newport 3)  
Model # 4262.05/4326, extended 4264.05

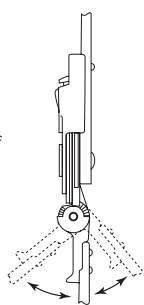

abduction/adduction adjusted  
in 7.5° increments

Lerman Hip Joint  
Model # 4205.01 (left)  
4206.01 (right)



Drop Lock Hip Joint  
Model # 4240 (left)  
4241 (right)



Chronic Hip Joint  
Model # 4210.01 (left)  
4211.01 (right)

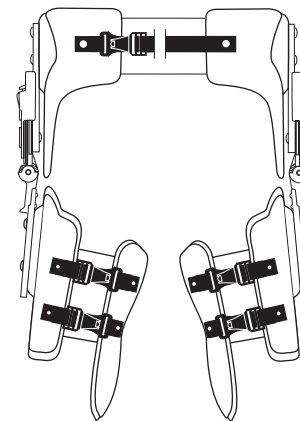

Newport 3 Bi-Lateral Hip System  
Model # 3768.02A  
(Please specify size)

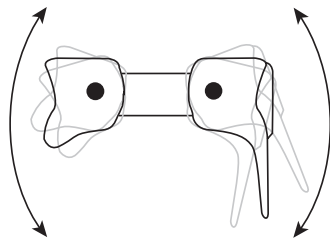

Rotational Adjustment

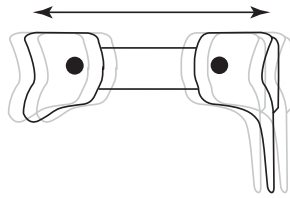

Lateral Adjustment

The **Newport 3 Pelvic Component** of the orthosis can be rapidly adjusted for both hip circumference and hip development while the patient is wearing the orthosis. The unique pivotal design allows components to move freely during the fitting process. Once the optimum position has been determined, the components are locked into place by tightening the two locking discs using the special Allen wrench provided with each orthosis. Available in side-specific or universal models. CoolFoam™ liner provided.

Size	Model #					Replacement Liners Model #	
	Left	Right	Universal	Waist Circ.	Hip Circ.	Side-Specific	Universal
Small	3650	3655	3650.01	22"-28"	26"-32"	3810.05	3810.06
Medium	3651	3656	3651.01	28"-34"	32"-38"	3811.05	3811.06
Large	3652	3657	3652.01	34"-40"	38"-44"	3812.05	3812.06
X-Large	3653	3658	3653.01	40"-46"	44"-50"	3813.05	3813.06

Fit 2X-Large sizes/waist circumferences 46" to 52" with waist expansion panel, Model # 4229

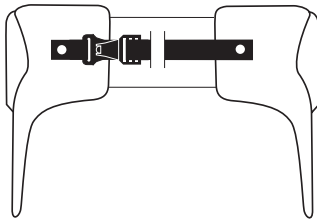

**Newport® 3 Bi-Lateral Pelvic Components** Adapted for bilateral application. The bilateral model features 2 modular pelvic components predrilled to accept hip joints. Features are described above. Click'n close fastener is standard, chafe and loop is also available.

Use Standard Newport 3 Pelvic Component sizing chart above. Pricing is for pre-fabricated pelvic section only. Additional charges apply if made custom-to-measurements. CoolFoam™ liner is provided.

Size	Model #
Small	3650.02
Medium	3651.02
Large	3652.02
X-Large	3653.02

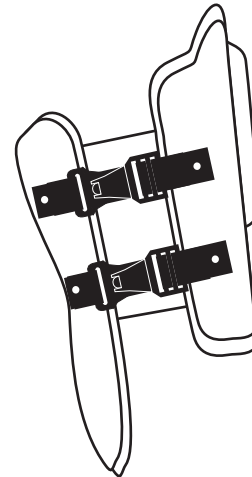

**Newport® 3 Thigh Component** Click'n close fastener is standard, chafe and loop closure is also available. CoolFoam™ liner is provided.

Size	Side-Specific Model #		Universal Model #	Proximal Circ.	Distal Circ.	Mid. Thigh	Replacement CoolFoam™ Liners		
	Left	Right					Left	Right	Universal
X-Small	3769.05	3774.05	NA	11"-17"	8"-13"	10"-16"	3819.05	3825.05	3820.04
Small	3770.05	3775.05	3770.01	15"-21"	12"-17"	13"-19"	3820.05	3826.05	3820.04
Medium	3771.05	3776.05	3771.01	17"-24"	13"-18"	15"-21"	3821.05	3827.05	3821.04
Large	3772.05	3777.05	3772.01	19"-27"	14"-20"	17"-24"	3822.05	3828.05	3822.04
X-Large	3773.05	3778.05	3773.01	21"-29"	17"-23"	19"-26"	3823.05	3829.05	3823.04

Special sizes available upon request (e.g., XXL, etc.) Extended hip joint Model #4264.05 recommended with Universal Thigh.

# Newport 4<sup>®</sup>

HIP SYSTEM

The totally modular and patented **Newport 4 Hip Orthosis** has been designed and engineered to provide the most comfortable hip orthosis for your patients with innovative new options to increase function and control.

- Low-profile design to improve patient comfort and compliance
- Padded posterior section for enhanced comfort and improved lordotic fit
- No proximal/medial plastic on thigh component to interfere with hygiene
- Thigh component design adjusts with clamping disc to accommodate varying shapes and to prevent knee flexion impingement
- Preset, quick release closures ensure same fit each time
- Patented clamping technology on pelvic band adjusts to male or female anatomy and a wide range of circumferences
- Universal pelvic design fits right and left to reduce inventory
- Also available with universal style thigh cuff

## Indications

- Post-op hip revision patients
- Primary arthroplasty patients at risk to dislocate, (e.g., patients with congenital hip dysplasia or spastic/tight adductors)
- As a prophylaxis to reinforce hip precautions
- Inoperable hip patients at risk

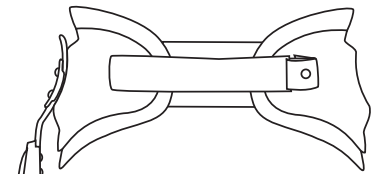

Anterior

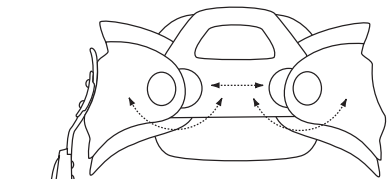

Posterior

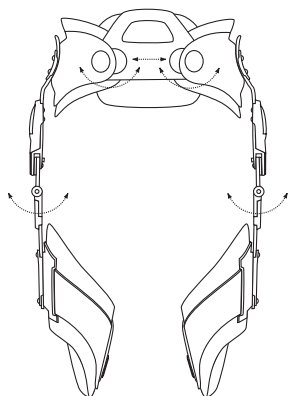

Newport 4 Bi-Lateral Hip System  
Model # **3742.02**

### Model # (with Virtual 5 Hip Joint)

Size	Side-Specific Thigh Cuff		Assembled with Universal Thigh Cuff		Waist Circ.	Hip Circ.	Mid. Thigh
	Left	Right	Left	Right			
Small	<b>3742</b>	<b>3746</b>	<b>3742.03</b>	<b>3746.03</b>	22"-28"	26"-32"	13"-19"
Medium	<b>3743</b>	<b>3747</b>	<b>3743.03</b>	<b>3747.03</b>	28"-34"	32"-38"	15"-21"
Large	<b>3744</b>	<b>3748</b>	<b>3744.03</b>	<b>3748.03</b>	34"-40"	38"-44"	17"-24"
X-Large	<b>3745</b>	<b>3749</b>	<b>3745.03</b>	<b>3749.03</b>	40"-46"	44"-50"	19"-26"

Standard with purple CoolFoam™ liner. Black CoolFoam liners available for a surcharge.

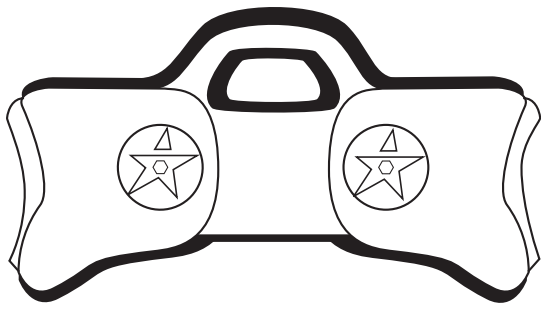

## Newport® 4 Pelvic Component with Coolfoam™ liner

Size	Model #	Waist Circ.	Hip Circ.	Replacement Liners Model #
Small	<b>3870</b>	22"-28"	26"-32"	<b>3810.02</b>
Medium	<b>3871</b>	28"-34"	32"-38"	<b>3811.02</b>
Large	<b>3872</b>	34"-40"	38"-44"	<b>3812.02</b>
X-Large	<b>3873</b>	40"-46"	44"-50"	<b>3813.02</b>



Curved proximal bar provides clearance over incision site



Adduction/Abduction in 7.5° increments



Flexion/Extension in 10° increments to 110°

**V5 Joint** The Virtual 5 Joint from Orthomerica was engineered to be the most versatile design for the Newport 4 Hip System. This joint can precisely fit all your entire patient population.

- Small joint head and lightweight design without sacrificing strength
- Easy access to all joint adjustments that are made with Allen wrenches
- Multiple bar choices allow the practitioner to position each component and hip joint more precisely for very short to very tall patients
- V5 Joint can fit all patient heights including those less than 5'2" and over 6' tall
- Available in standard and extended curved proximal bars
- Available in 2, 3, and 4-slot distal bars for optimal placement of the thigh component
- The Newport 4 is an extremely versatile orthosis. The V5 Joint complements the wide range of thigh cuff options and patient diversity. Select your favorite thigh component to find the perfect V5 Joint for your patients

	Model #
<b>Standard Curved Proximal Bar with 2 slot Distal Bar</b>	<b>4320</b>
<b>Standard Curved Proximal Bar with 3 slot Distal Bar</b> Fits the majority of patients with Newport 4 or Newport 3 thigh components	<b>4321</b>
<b>Standard Curved Proximal Bar with 4 slot Distal Bar</b> Fits the majority of patients with Universal thigh components	<b>4322</b>

For extremely short or extremely tall patients, contact customer service for alternate bar length.

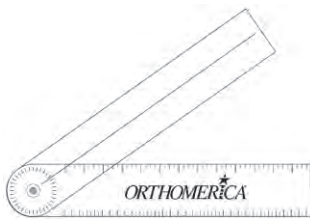

Newport® Goniometer **3876**

## Newport 4 Side-Specific Thigh Component

Fits both men and women, with CoolFoam™ Liners

Size	Model #					Replacement Liners	
	Left	Right	Proximal Circ.	Distal Circ.	Mid. Thigh	Left	Right
Small	<b>3770.06</b>	<b>3775.06</b>	15"-21"	12"-17"	13"-19"	<b>3820.02</b>	<b>3825.02</b>
Medium	<b>3771.06</b>	<b>3776.06</b>	17"-24"	13"-18"	15"-21"	<b>3821.02</b>	<b>3826.02</b>
Large	<b>3772.06</b>	<b>3777.06</b>	19"-27"	14"-20"	17"-24"	<b>3822.02</b>	<b>3827.02</b>
X-Large	<b>3773.06</b>	<b>3778.06</b>	21"-29"	17"-23"	19"-26"	<b>3823.02</b>	<b>3828.02</b>



Side-Specific



Universal

## Newport Universal Thigh Component

Universal—fits left and right, both men and women, with CoolFoam™ Liners

Size	Model #				Replacement Liners
	Model #	Proximal Circ.	Distal Circ.	Mid. Thigh	Model #
Small	<b>3770.01</b>	15"-21"	12"-17"	13"-19"	<b>3820.04</b>
Medium	<b>3771.01</b>	17"-24"	13"-18"	15"-21"	<b>3821.04</b>
Large	<b>3772.01</b>	19"-27"	14"-20"	17"-24"	<b>3822.04</b>
X-Large	<b>3773.01</b>	21"-29"	17"-23"	19"-26"	<b>3823.04</b>

Requires extended joint.

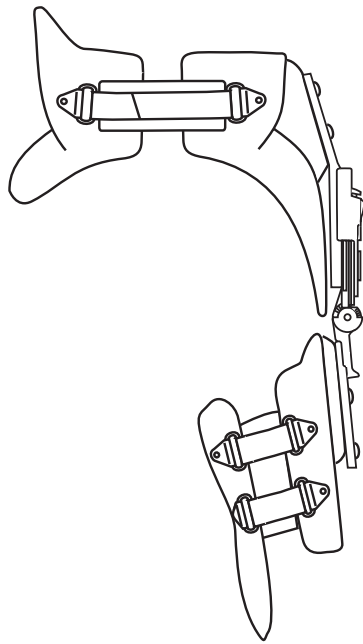

**Newport® MC** Designed for more involved post-operative hip patients, this pre-fabricated, modified body jacket version of the Newport Hip Orthosis enables the orthopaedic professional to stock certain sizes for immediate fitting. Eliminates overnight shipping charges. Especially effective for patients prone to chronic dislocation due to involved total hip revision.

- Comfortable, positive control of adduction/flexion/extension
- Improved biomechanics with high contralateral extension
- Unique locking feature to keep pelvic section level

Size	Model #		Waist Circ.	Hip Circ.	Mid-Thigh Circ.	Pelvic Liner Model #	
	Left	Right				Left	Right
Small	<b>3790</b>	<b>3795</b>	25"-29"	32"-36"	13"-19"	<b>3840.01</b>	<b>3845.01</b>
Medium	<b>3791</b>	<b>3796</b>	29"-33"	36"-40"	15"-21"	<b>3841.01</b>	<b>3846.01</b>
Large	<b>3792</b>	<b>3797</b>	33"-37"	40"-44"	17"-24"	<b>3842.01</b>	<b>3847.01</b>
X-Large	<b>3793</b>	<b>3798</b>	37"-41"	44"-48"	17"-24"	<b>3843.01</b>	<b>3848.01</b>

Available custom-to-measurements. For thigh sizing reference NP3 chart on page 26.

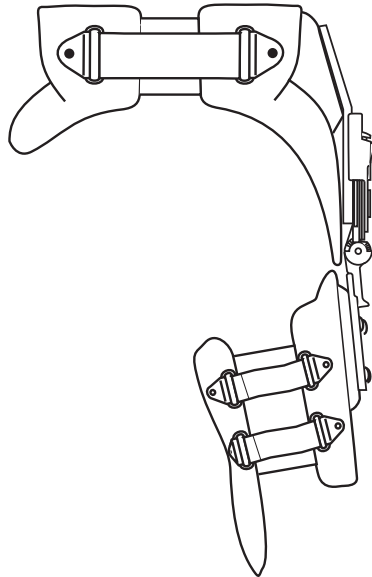

**Newport® Full Figure** Specially designed pelvic section for patients with large hips who are traditionally hard-to-fit with pre-fabricated pelvic sections without excessive waist gapping. Indicated when the difference between hip and waist circumferences is greater than 8".

Size	Model #		Waist Circ.	Hip Circ.	Mid-Thigh Circ.	Pelvic Liner Model #	
	Left	Right				Left	Right
Small	<b>3780</b>	<b>3785</b>	22"-26"	32"-36"	13"-19"	<b>3860.01</b>	<b>3865.01</b>
Medium	<b>3781</b>	<b>3786</b>	27"-31"	37"-41"	15"-21"	<b>3861.01</b>	<b>3866.01</b>
Large	<b>3782</b>	<b>3787</b>	31"-35"	43"-47"	17"-24"	<b>3862.01</b>	<b>3867.01</b>
X-Large	<b>3783</b>	<b>3788</b>	35"-40"	47"-53"	17"-24"	<b>3863.01</b>	<b>3868.01</b>

Available custom-to-measurements. For thigh sizing reference NP3 chart on page 26.

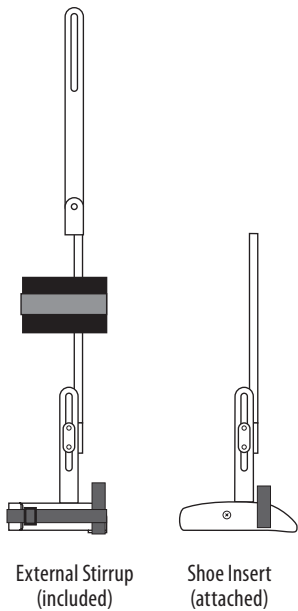

**Newport® ARC™ Kit** The ARC kit is an optional, modular component designed to maintain the affected limb in either internal or external rotation. It is indicated for primary or revision total hip arthroplasty patients at risk to dislocate in an anterior or posterior direction. The ARC can be retrofitted on any adult Newport System.

Size	Model #		Knee Center to Floor	Shoe Size
	Left	Right		
Short	<b>3670</b>	<b>3673</b>	15"	Men 5-7 Women 6 or less
Medium	<b>3671</b>	<b>3674</b>	17"	Men 7½-10 Women 6½ up
Long	<b>3672</b>	<b>3675</b>	19"	Men 7½-10 Women 6½ up
X-Long	<b>3672X</b>	<b>3675X</b>	21"	Men 10½-13
XX-Long	<b>3672XX</b>	<b>3675XX</b>	22"-25"	Men 10½-13

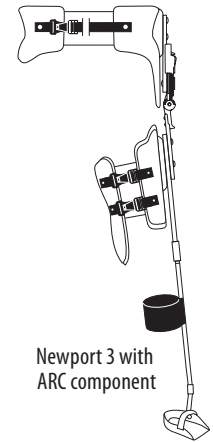

Any shoe size can be substituted at no additional charge.

Fits all adult Newport Hip Systems and includes External Stirrup and Heel Cup Shoe Insert.

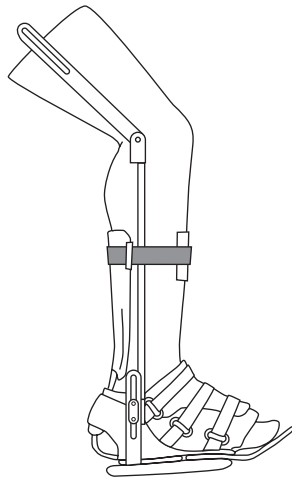

**PRAFO® Shoe Option** The PRAFO option is indicated for hospital or homebound patients prone to heel skin breakdown. The PRAFO elevates the heel and can be removed for daytime ambulation. Knee center to floor measurements are needed for this custom-to-measurement orthosis. All PRAFO Shoe Options include a Newport ARC Kit. Not sold separately.

Model # **3676** (Please specify right or left when ordering.)

PRAFO® (Pressure Relief Ankle Foot Orthosis) is a registered trademark of Anatomical Concepts, Inc.

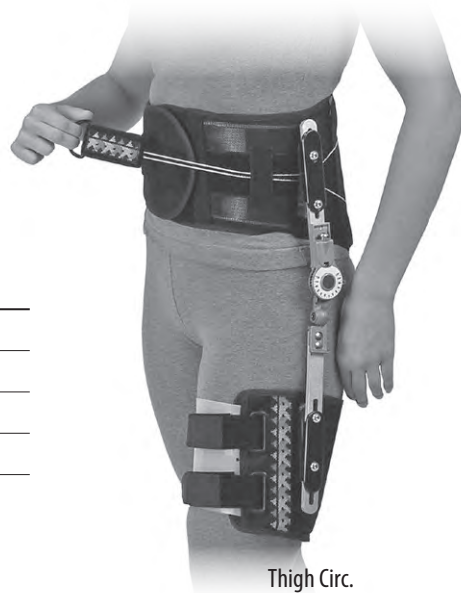

The **California Hip Orthosis** is the latest innovation in Orthomerica's leading hip orthosis designs which helps to prevent dislocation. The California Hip Orthosis was created to facilitate the best pelvic and thigh control and minimize the bulk of conventional hip orthoses for patients at risk to dislocate.

**Features**

- Comfortable, total-contact reinforced mesh pelvic component based on the popular California Compression Orthosis supports the back and aligns pelvis and hip joint
- Universal pelvic, thigh and hip joint components reduce inventory and make stocking all sizes more cost efficient
- Hip joint settings provide a strong flexion/extension stop with mild, adjustable resistance to adduction
- Patient-adjustable abdominal compression to increase comfort during activities of daily living
- Abduction wedge regulates the clearance of the hip joint over the trochanter and incision site

Size	Components	
	Pelvic	Thigh
Small	<b>3970</b>	<b>3976</b>
Medium	<b>3971</b>	<b>3977</b>
Large	<b>3972</b>	<b>3978</b>
X-Large	<b>3973</b>	<b>3979</b>

Size	Model #		Waist Circ.	Hip Circ.	Thigh Circ.	
	Left	Right			Proximal	Distal
Small	<b>3960</b>	<b>3965</b>	22"-28"	26"-32"	15"-21"	12"-17"
Medium	<b>3961</b>	<b>3966</b>	28"-34"	32"-38"	17"-24"	13"-18"
Large	<b>3962</b>	<b>3967</b>	34"-40"	38"-44"	19"-27"	14"-20"
X-Large	<b>3963</b>	<b>3968</b>	40"-46"	44"-50"	21"-29"	17"-23"

Standard Hip Joint Kit—Model # **3955.01**

**Newport® jr Pediatric Hip Orthosis** The Newport jr Hip System with the new pj—Virtual Pediatric Joint enhances hip stability by supporting and positioning the hips in optimal alignment while allowing controlled range of motion. This pediatric hip orthosis can be used post-operatively to maintain the corrected surgical position, or can be provided to maximize function during activities of daily living. Improved alignment through the hip encourages appropriate acetabular and femoral modeling, and reduces the tendency for subluxation and dislocation.

**Indications**

- Post-operative stabilization of the pediatric hip
- Patients with subluxed hips who require better alignment to relieve pain
- Children needing improved sitting and standing balance

**Features**

- Universal pelvic module, bilateral thigh cuffs, comfortable lumbar pad
- Anatomical design captures and stabilizes the pelvis
- Washable Coolfoam™ liners
- Available in five sizes

**Virtual® Pediatric Joint (pj)**

- The smallest and lightest hip joint available in the industry
- Adjustable control of flexion, extension, abduction and adduction
- Curved proximal joint attachments provide clearance over the incision and trochanter
- Joints with straight bars available in short, long and unslotted configurations for sale as components

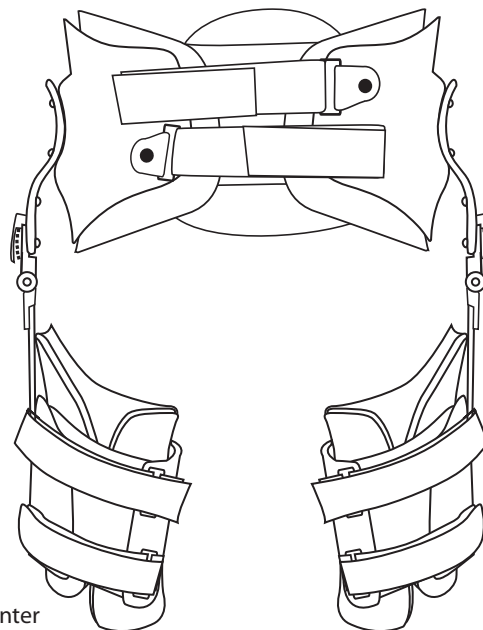

Size	Model #	Waist Circ.	Hip Circ.	Mid Thigh Circ.	Trochanter to Knee Center Length	pj Joint Distal Bar Size	pj Joint Model #
X-Small	<b>3919</b>	17 <sup>7</sup> / <sub>8</sub> -19"	18-20"	9 <sup>7</sup> / <sub>8</sub> -10 <sup>7</sup> / <sub>8</sub> "	7 <sup>1</sup> / <sub>4</sub> -8 <sup>1</sup> / <sub>2</sub> "	Ex-short	<b>4310</b>
Small	<b>3920</b>	18 <sup>3</sup> / <sub>4</sub> -20 <sup>1</sup> / <sub>4</sub> "	20-22"	10 <sup>5</sup> / <sub>8</sub> -12 <sup>3</sup> / <sub>16</sub> "	8 <sup>1</sup> / <sub>8</sub> -10 <sup>1</sup> / <sub>8</sub> "	Short	<b>4311</b>
Medium	<b>3921</b>	20-22"	22-25"	11 <sup>3</sup> / <sub>16</sub> -13 <sup>3</sup> / <sub>4</sub> "	9 <sup>1</sup> / <sub>2</sub> -11 <sup>7</sup> / <sub>8</sub> "	Short	<b>4311</b>
Large	<b>3922</b>	21 <sup>3</sup> / <sub>4</sub> -23 <sup>3</sup> / <sub>4</sub> "	25-27"	12 <sup>3</sup> / <sub>4</sub> -15 <sup>3</sup> / <sub>16</sub> "	11 <sup>1</sup> / <sub>2</sub> -14"	Long	<b>4312</b>
X-Large	<b>3923</b>	23 <sup>1</sup> / <sub>2</sub> -25 <sup>1</sup> / <sub>2</sub> "	27-30"	14-16 <sup>7</sup> / <sub>8</sub> "	13 <sup>7</sup> / <sub>8</sub> -16 <sup>3</sup> / <sub>8</sub> "	Long	<b>4312</b>

Add **RL** suffix to part numbers for replacement liner sets, (e.g., **3920RL** is a complete liner set for the small Newport jr and **3940RL** is a liner set for the small left Newport jr Thigh) Replacement liners available. Available unilateral too.

**Custom Hinge Components (Straight Bars)**

Size	Model #	Joint Center To Proximal Bar	Joint Center To End Of Distal Bar
Short	<b>4315</b>	3 <sup>13</sup> / <sub>16</sub> "	7 <sup>13</sup> / <sub>16</sub> "
Long	<b>4316</b>	3 <sup>13</sup> / <sub>16</sub> "	10 <sup>15</sup> / <sub>16</sub> "
Long—unslotted	<b>4317</b>	5 <sup>5</sup> / <sub>16</sub> "	10 <sup>15</sup> / <sub>16</sub> "

**Pelvic and Thigh Components**

Size	Pelvic Assembly Model #	Thigh Assembly Model #	
		Left	Right
X-Small	<b>3929</b>	<b>3939</b>	<b>3944</b>
Small	<b>3930</b>	<b>3940</b>	<b>3945</b>
Medium	<b>3931</b>	<b>3941</b>	<b>3946</b>
Large	<b>3932</b>	<b>3942</b>	<b>3947</b>
X-Large	<b>3933</b>	<b>3943</b>	<b>3948</b>

**Optional Adjustable Abduction Bar**

Size	Attached	Kit Only
Short (For XS and S Pelvic Sections—6.35" to 9.85" adjustment range)	<b>3950</b>	<b>3950.01</b>
Long (For M, L and XL Pelvic Sections—9.675" to 17" adjustment range)	<b>3951</b>	<b>3951.01</b>





**Pediatric Hip Abduction Splints** Maintains concentric reduction of hips in patients with hip dysplasia. Replaces spica casts and harnesses for certain neuromuscular and developmental dysplasia patients. One piece polypropylene orthosis holds infant in 90° hip flexion and 60° abduction, adjustable model offers easily adjustable abduction from 40° through 180° by aluminum slotted screw assembly. Fits infants from 3 months (6-12 lbs.) to 18 months (over 30 lbs). Indicated for infants and young children with subluxed hips or to prevent subluxation and dislocation.

Size	Waist Circ.	Thigh Circ.	Adjustable Model #	Standard Model #	Age/Weight Guidelines
X-Small			<b>3906</b>	<b>3899</b>	Up to 3 mos. (6-12 lbs.)
Small			<b>3907</b>	<b>3900</b>	3-6 mos. (13-16 lbs.)
Medium	19"	12"	<b>3908</b>	<b>3901</b>	6-12 mos. (17-21 lbs.)
Large	21"	15"	<b>3909</b>	<b>3902</b>	1 year (22-30 lbs.)
X-Large			<b>3910</b>	<b>3903</b>	18 mos. (30+ lbs.)

